

Andreu World

Contemporary
Design
Manufacturing
Culture

Tables

Andreu World

Contemporary
Design
Manufacturing
Culture

Tables

Design and quality of life make up the essence of our creations. In this new catalog we present a wide range of tables collections, based in freedom of imagination. We are not bound to general industry formalities, affording us endless selections of materials, technologies, finishes and colors. These values are accompanied by a constant commitment to the environment and to minimizing environmental impact in the production of all our collections. To do so, Andreu World works with 100% sustainable wood obtained from replenished forests that are certified by the Forest Stewardship Council (FSC®). The FSC chain-of-custody guarantees wood practices from the origin of the raw material to the finished product. Since its inception, Andreu World has been faithful to its mission: manufacture products with carefully chosen materials that convey quality of life; design elegant pieces from their conception; establish a discreet dialogue in all types of spaces, in all types of rooms and in the diverse locations around in the world. This versatility allows us to work closely with architects, designers, and creators from many different cultures, all of whom see in Andreu World a reality capable of resolving and providing high quality solutions in all types of projects and environments, from the favorite corner of our home to the public spaces.





Diseño y calidad de vida forman parte de la esencia de todas nuestras creaciones. En este catálogo te presentamos una amplia gama de mesas que expresan una profunda cultura de calidad, diseño y una búsqueda constante de armonía, bienestar e innovación, basados en una extensa libertad de propuestas formales, materiales, tecnología, acabados y colores. A estos valores, se suma el compromiso constante con el respeto al medio ambiente y la minimización del impacto ambiental en la producción de todas nuestras colecciones. Por ello, Andreu World, trabaja con el 100% de la madera sostenible, procedente de bosques reforestados que cuentan con la certificación FSC® (Forest Stewardship Council) y garantizan el cumplimiento de la cadena de custodia, desde su origen hasta el producto final.

Desde su creación, Andreu World es fiel a una constante: fabricar piezas con materiales muy cuidados que transmitan calidad de vida. Piezas elegantes que desde su concepción establecen un diálogo discreto en todo tipo de espacios, en cualquier tipo de ambiente y en los lugares más dispares del mundo. Esta versatilidad nos permite trabajar estrechamente con arquitectos, diseñadores, interioristas y creadores de muy diversas culturas, que ven en Andreu World una realidad capaz de solucionar y dar respuestas de la máxima calidad en todo tipo de proyectos y entornos, desde el rincón preferido de nuestro hogar hasta los espacios públicos.

Andreu World offers more references and versions other than what is shown in this catalog. For more information, consult the commercial department or visit our website at: www.andreuworl.com

Andreu World dispone en su oferta de más referencias y versiones de las que se muestran en este catálogo. Para más información, consultar con el departamento comercial o visitar nuestra web: www.andreuworl.com



If the world is moving at an unstoppable pace, we will continue to seek new ways to respond and adapt to these changes and, if possible, try to be able to anticipate what may arise.

This catalog contains a new series of designs that adapt to new behaviors, needs and desires; products that evolve and amend certain things to remain being the same. Andreu World has made a constant search for new proposals, researching the quality and strength of materials, innovation and sustainability.

In this sense, Andreu World continues on the path that was started more than 65 years ago, which is to improve its products and the variety of its uses in all kinds of applications and in any architectural space. Appropriate to the times, our product moves towards corporate solutions adapting to new habits and ways of life, integrating into corporate spaces, the private environment of our home or collective places such as hotels and restaurants to public, institutional and educational buildings.

Si el mundo avanza de manera imparable, y esa es su razón de ser, nosotros vamos a seguir buscando nuevos modos de respuesta y adecuación ante esos cambios y, a ser posible, tratar de ser capaces de anticiparlos.

Este catálogo contiene una serie de diseños que se adaptan a nuevos comportamientos, necesidades y deseos; productos que avanzan y modifican algunas cosas para seguir siendo los mismos. Andreu World ha hecho de la búsqueda constante de nuevas propuestas, de la calidad y resistencia de los materiales, de la innovación y la sostenibilidad. En este sentido, Andreu World sigue en el camino iniciado hace más de 65 años, mejorando sus productos y la polivalencia de sus usos en todo tipo de ambientes y cualquier espacio arquitectónico. Adecuado a los tiempos, nuestros productos avanzan adaptándose a los nuevos hábitos y formas de vida, integrándose en los espacios corporativos, el entorno privado de nuestro hogar o los lugares colectivos como hoteles y restaurantes hasta edificios públicos, institucionales y educativos.

Guarantee Garantía

*10

10-year guarantee on our products against material and manufacturing defects.

10 años de garantía en nuestros productos contra todos los defectos en materiales y procesos de elaboración.

Quality and environmental Policy Política de calidad y medioambiente

Andreu World has implemented environmental management systems in our manufacturing processes and we operate in accordance with all major international standards and certifications of compliance and environmental care for our products. These standards and certifications are the ultimate guarantee of the sustainable, durable and quality tables that we produce. In this context, the implementation of 14006 Ecodesign certification and the UNE EN ISO 9001 and 14001 standard to our collections has allowed us to rethink our furniture solutions in order to optimize energy consumption during manufacturing and to improve the processes of finishing, painting, packaging and logistics.

Andreu World is accredited with LEVEL® certification. This international standard promotes the social responsibility of our designs and assumes the maximum guarantee of transparency in the production process. This standard is widely implemented in the North American market and serves as a reference for choosing the more sustainable furniture.

Andreu World ha implementado sistemas de gestión medioambiental en sus centros de producción, y cumple con las principales normas y certificaciones internacionales de respeto y cuidado ambiental para sus productos. Esta es la máxima garantía que nos permite ofrecer mesas de calidad, sostenibles y duraderas procedentes de un proceso de fabricación respetuoso en todo el ciclo de vida del producto. En este contexto, la aplicación de la certificación Ecodiseño ISO 14006 y las normativas ISO 9001 e ISO 14001 sobre nuestras colecciones permite ofrecer soluciones de mobiliario pensadas para optimizar su consumo energético en la fase de fabricación y conseguir una mejora en otros procesos de acabados, pintura, embalaje o logística.

Andreu World cuenta con la certificación LEVEL®. Este estándar internacional impulsa la responsabilidad social de nuestros diseños y supone la máxima garantía de transparencia en el proceso de producción. Esta normativa está ampliamente implantada en el mercado norteamericano y sirve de referencia para arquitectos, diseñadores e interioristas a la hora de elegir mobiliario más sostenible.

Design protection Protección del Diseño



All Andreu World designs are protected by industrial design registries, design patents, copyrights, and other intellectual property rights worldwide.

Todos los diseños de Andreu están protegidos por registros de diseño industrial, design patent, copyright y derechos de propiedad intelectual en todo el mundo

Design Award Premios de Diseño



Andreu World has been internationally recognized with the Red Dot Design Awards Award, Compasso d'Oro. Menzione d'Onore, Best of NeoCon, Wallpaper Awards, HD Boutique Awards, Miami Best of Boutique Awards. In Spain, received the 2007 National Design Award.

Andreu World ha sido reconocida internacionalmente con galardones como los Premios Red Dot Design Award, Compasso d'Oro. Menciones d'Onore, Best of NeoCon, Wallpaper Award, HD Boutique Awards, Best of Miami Boutique Awards. En España, recibió el Premio Nacional de Diseño 2007.

100% Sustainable wood Madera 100% sostenible



The mark of responsible forestry

100% of our products made of solid wood are accredited with the certificate (FSC). Products are independently certified to assure consumers that the wood in their product comes from forests managed in socially, economically and environmentally responsible manners ensuring the resource for future generations.

El 100% de nuestros productos realizados en madera maciza están acreditados con el certificado FSC (Forest Stewardship Council Certification). Los productos son independientemente certificados para asegurar a los clientes que proceden de bosques gestionados para cumplir las necesidades sociales, económicas y ambientalmente responsables de generaciones futuras.

Search our offering of FSC® (Forest Stewardship Council®) certified products at www.andreuworld.com

Busque nuestros productos con certificación FSC® (Forest Stewardship Council®) en www.andreuworld.com

Tables / Mesas



**262
Arc
Table**



**014
Closed**



**206
Colors**



**268
Couvé
Table**



**214
Dual**



**274
Dual
Occasional**



**284
Element
Table**



**036
Extra
Table**



**186
Nuez
Table**



**292
Nuez Table
Occasional**



**228
Plaza**



**238
Quattro**

Tables / Mesas



**298
Quattro
Occasional**



**066
Radial
Conference
Table**



**306
Raglan
Table**



**250
Reverse**



088
Reverse
Conference
Table



150
Sistema SP



192
Uves



130
Reverse
Conference
Lounge



168
Status



338
Uves
Occasional



314
Reverse
Occasional

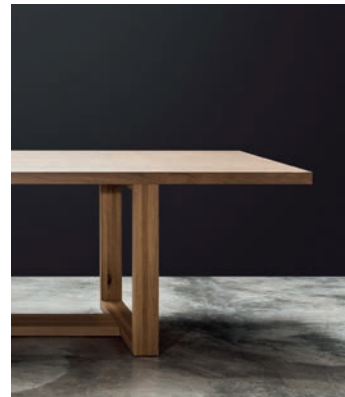

192
Tao



332
Ruta
Table



344
Tops

This table system stands out for its balanced proportions and technological detailing. It combines exquisite wood treatments with a built-in connection system (electrical and multimedia) to guarantee functionality and representativeness.

Este programa de mesas destaca por sus proporciones equilibradas y sus detalles tecnológicos. Combina un tratamiento exquisito de la madera con un sistema integrado de conexiones –eléctricas y multimedia– que garantiza su funcionalidad además de su representatividad.

Closed

by Estudio Andreu



Conference room
Sala de reunión
▼ ME6206 / SI1304
Table with lacquered top
and legs.
Mesa con sobre y pies
lacados.



Home office
▼ ME6211 / SO2773
Table with lacquered top
and legs.
Mesa con sobre y pies
lacados.



Educational
Educacional
▼ **ME6332** / BU1348
Occasional table with
oak top and legs.
Mesa auxiliar con sobre
y pies de roble.



Workspace
Espacio de trabajo
▼ **ME6137** / BQ0599
Bar height table with solid oak
wood top and legs.
Mesa alta con sobre y pies de
madera de roble.



Home

Hogar

► **ME6107** / SI7291

Table with oak top and legs.

Mesa con sobre y pies en roble.

Cafeteria

Cafetería

▼ **ME6139** / BQ1209

Table with oak top and legs.

Mesa con sobre y pies de roble.



Workspace

Espacio de trabajo

▼ **ME6243** / BQ1677

Table with lacquered top and legs.

Mesa con sobre y pies lacados.



▼ **BC6302**

Bench with oak wood seat and legs. Three seater upholstered cushion.
Banco con asiento y pies de madera de roble. Cojín tapizado de tres plazas.

▼ **ME6158**

Table with solid walnut wood top and legs.
Mesa con sobre y pies de madera de nogal.



Workspace

Espacio de trabajo

▼ **ME6106** / SO2061

Table with solid oak wood top and legs.
Mesa con sobre y pies de madera de roble.



Meeting tables / Mesas de reunión

Closed Table is a collection of tables with balanced proportions, sculptural shape and technological details that offer outstanding design for any environment. Available in walnut or oak veneer, laminate or lacquered; this collection combines design with functionality; with an integrated system of connections that makes it the perfect table for conference rooms. It represents a high level of experience in wood working; The Closed conference tables are made from 100% FSC certified wood and offers solutions for a wide range of applications due to its different heights, widths and lengths, including a version of bench with cushions.

Closed Table es un programa de mesas con unas equilibradas proporciones, forma escultural y detalles tecnológicos que ofrecen un diseño excepcional para cualquier entorno. Disponible en chapa de nogal o de roble, laminado o acabado lacado, este programa une diseño con funcionalidad mediante un sistema de conexiones integrado que la convierte en el futuro de las mesas de reuniones. Representando un elevado nivel de experiencia en el trabajo de la madera, las mesas del Closed Table están realizadas con madera 100% Sostenible con certificación FSC® y ofrece soluciones para un amplio rango de usos gracias a sus diferentes alturas, anchuras y longitudes incluyendo versiones de bancada con cojines.

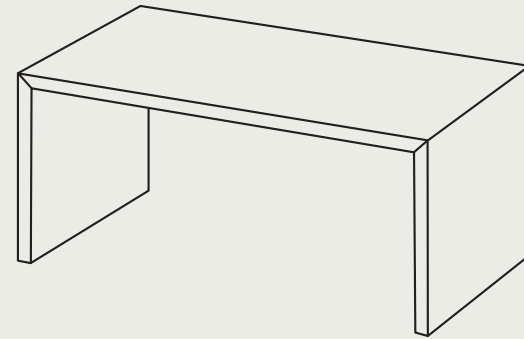

Oak Roble

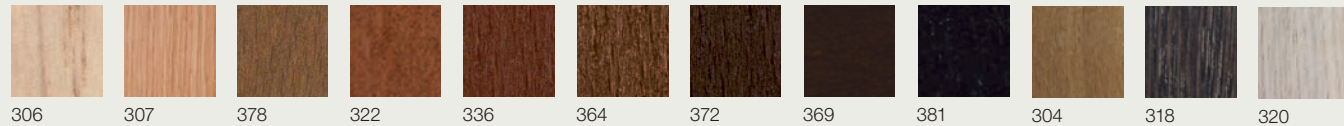

Premium finishes and wood lacquers Acabados premium y lacados

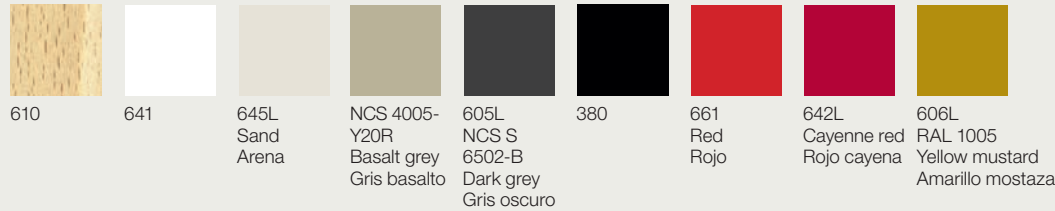

Laminate Laminado

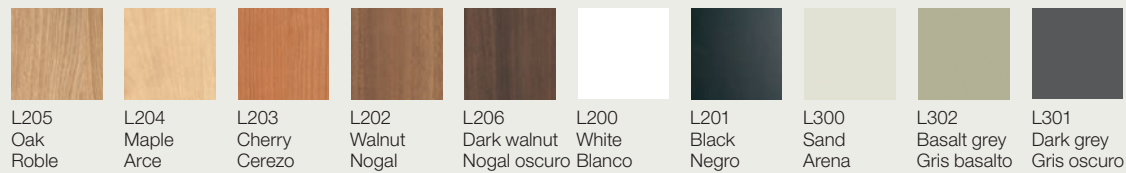

Walnut Nogal

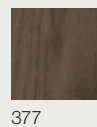

377

Meeting tables / Mesas de reunión



High tables Mesas altas

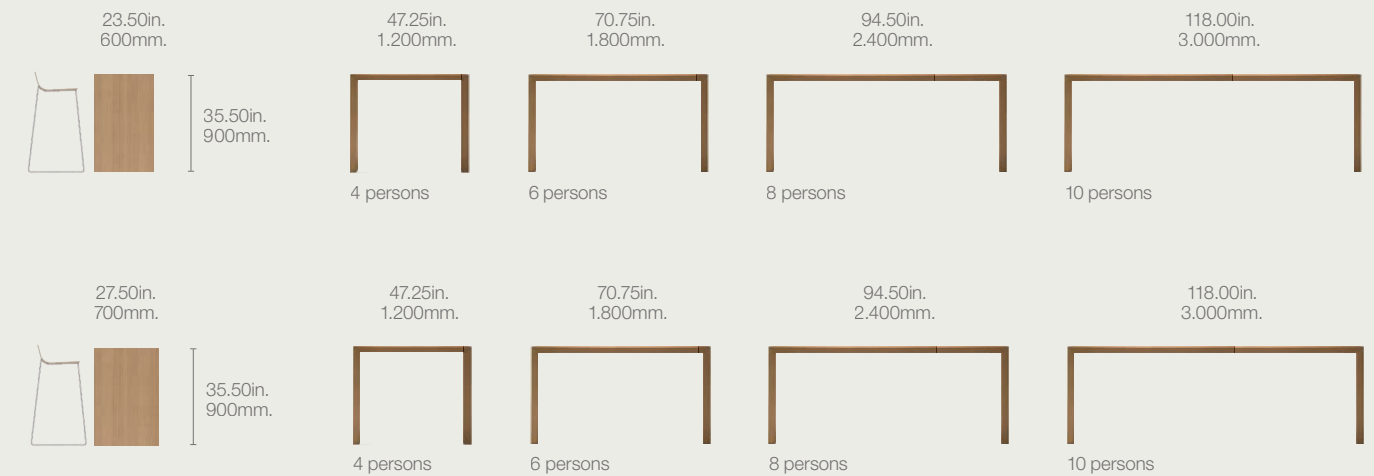

High tables / Mesas altas

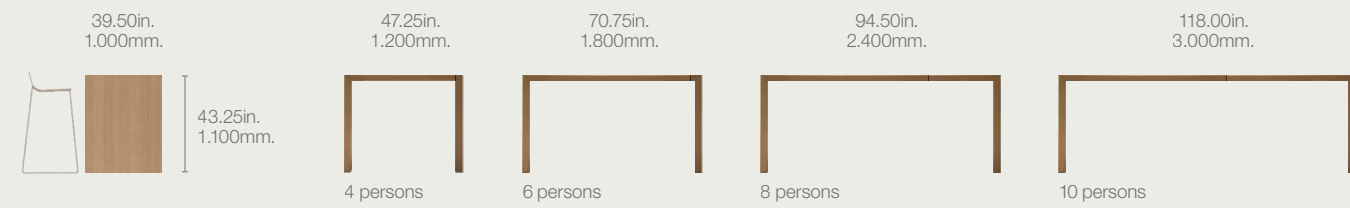
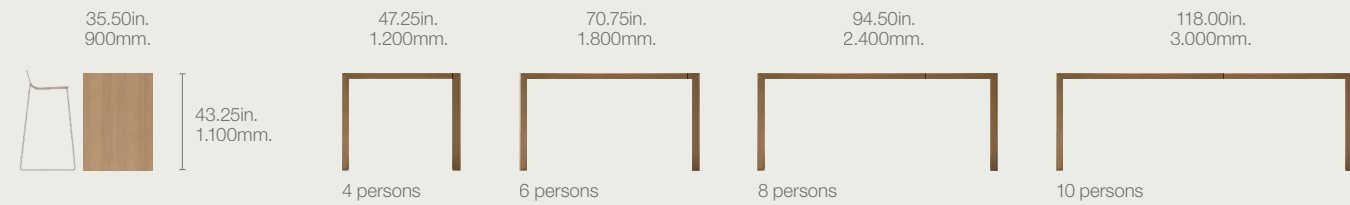
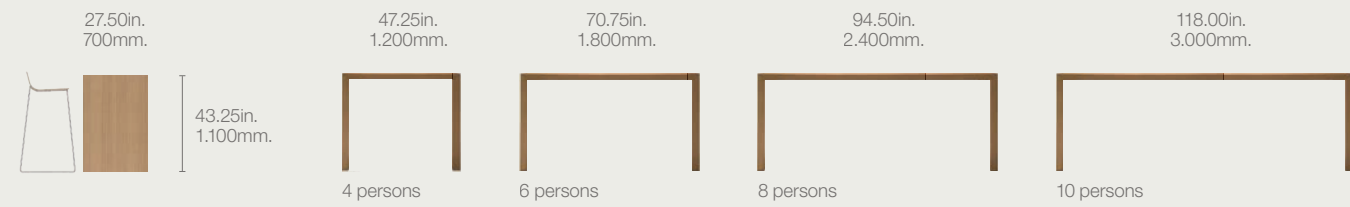
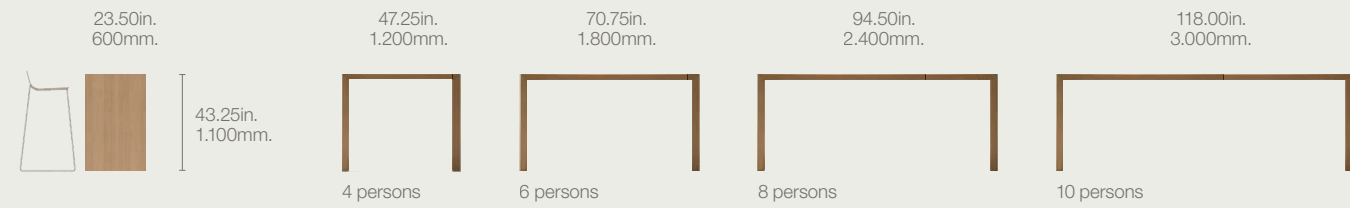
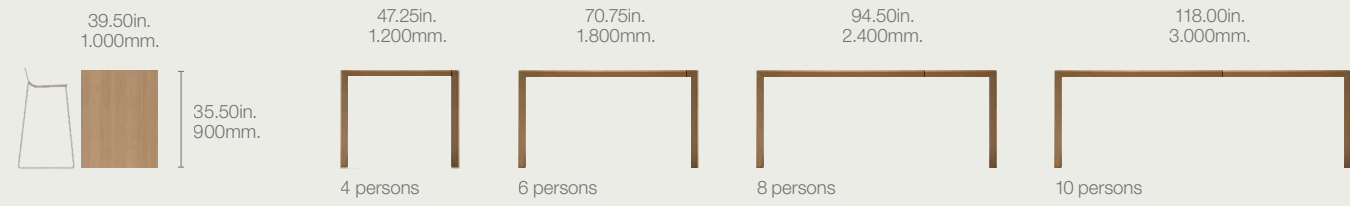
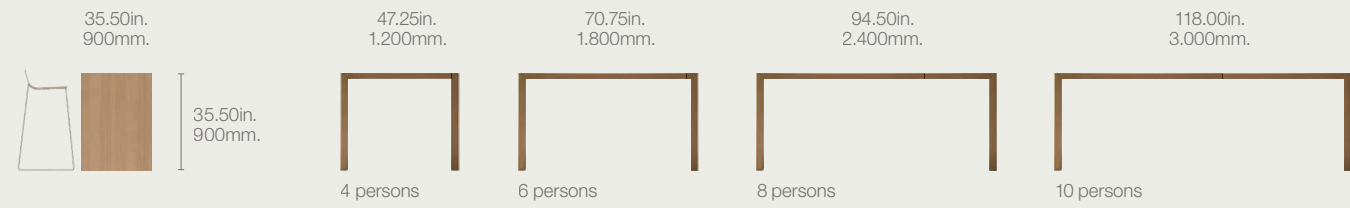

Occasional tables / Mesas auxiliares

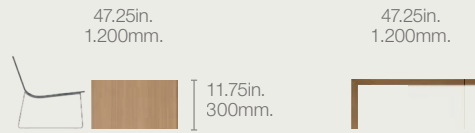
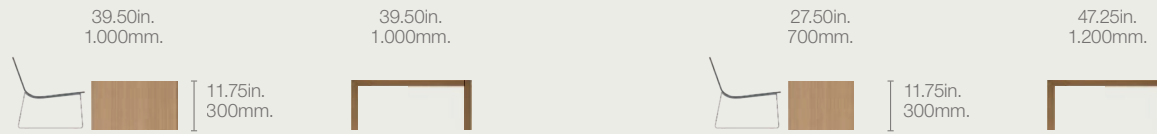
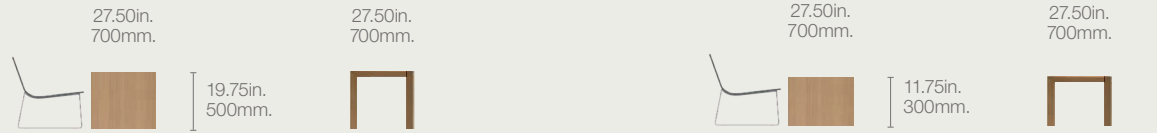

Benches / Bancos

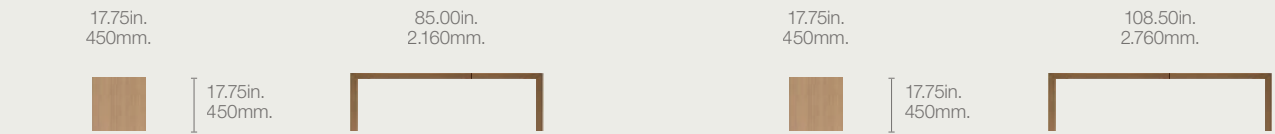
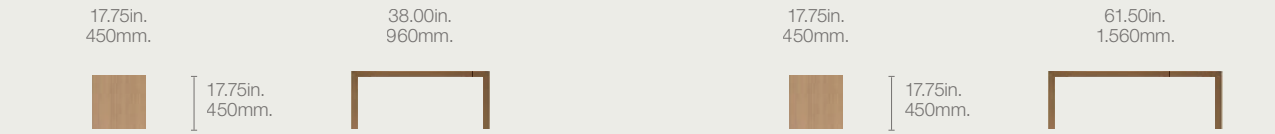

Optional cushions
Cojines opcionales



Wire management / Conectividad

**Distribution
Distribución**

- 1. System distribution:** As standard, the connection system will be located in the center of the table. For tables with more than one system, these will be placed with a separation of 1/3 of the total length of the table and in the longitudinal direction.
- 2. Wire management:** The cable leaves the power system, passes through an aluminum profile and travels down the leg.
- 3. Wiring outlet:** The cable exits directly from the connection system through an aluminum profile that hides the wiring and down the inside of the leg to reach the ground.

PS0711
PS0721

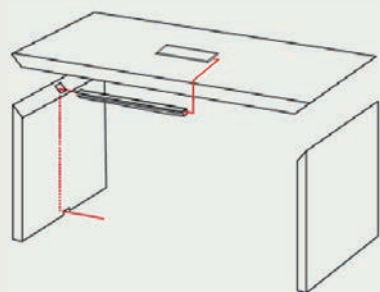

PS0752
PS0753

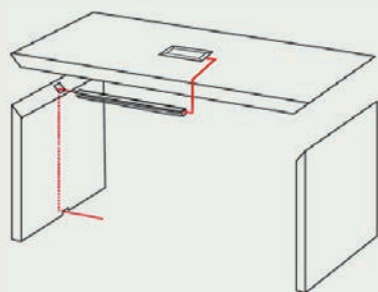

Hard wired,
aplicable to PS
0752 and PS 0753
They are offered as
an extra option.
Hard wired, aplicable
a PS 0752 y PS 0753
Se ofrecen como
una opción extra.

PS0755
PS 0756

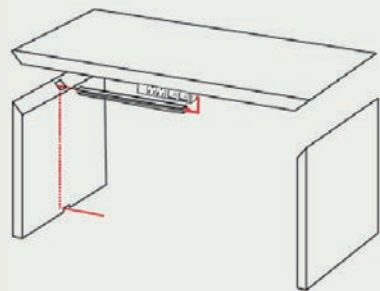

PS0750
PS0751

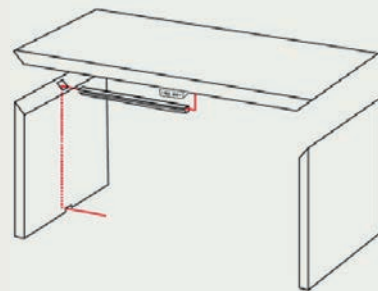

PS0716
PS0717

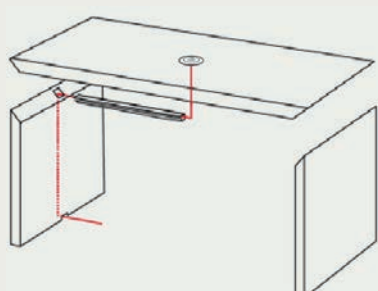
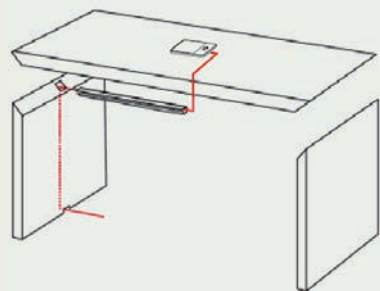

PS0715

PS0718

America

Closed

Wire management / Conectividad

**In surface
En superficie**



Integrated connection system

Composed of an interior cover with the same finish as the table top, and exterior frame in matt black finish. Its opening is made on both sides. Two system sizes are available, configurable from 2 + 2 or 3 + 3 where 1 or 2 power ports are included depending on the choice + 1 USB charging port and the rest are configurable, and may include Minijack, VGA, HDMI, USB data ports or RJ45.

Sistema de conexiones integrado

Compuesto por una tapa interior con el mismo acabado que el sobre y un marco exterior de acabado negro mate. Su apertura se realiza en ambos lados. Se ofrecen dos tamaños de sistemas, configurables de 2+2 o 3+3 donde se incluyen 1 o 2 powers dependiendo de la elección + 1 USB de carga y los restantes son configurables, pudiendo incluir Minijack, VGA, HDMI, USB de datos o RJ45.



PS0711

PS0721

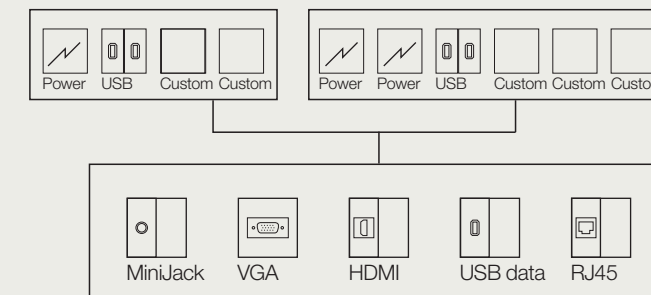

**In surface
En superficie**



Integrated connection system

Composed of an interior cover with an exterior frame, both in anodized finish. Its opening is made by a soft touch. Two system sizes are available, configurable from 2 + 2 or 3 + 3 where 1 or 2 power ports are included depending on the choice + 1 USB charging port and the rest are configurable, and may include Minijack, VGA, HDMI, USB data ports or RJ45.

Sistema de conexiones en superficie

Compuesto por una tapa interior y un marco exterior, ambos en acabado anodizado. Su apertura se realiza con una suave pulsación. Se ofrecen 2 tamaños de sistemas, configurables 2+2 o 3+3 donde se incluyen 2 o 3 powers dependiendo de la elección, y los restantes son configurables, pudiendo incluir Minijack, VGA, HDMI, USB de datos o RJ 45.



PS0752

PS0753

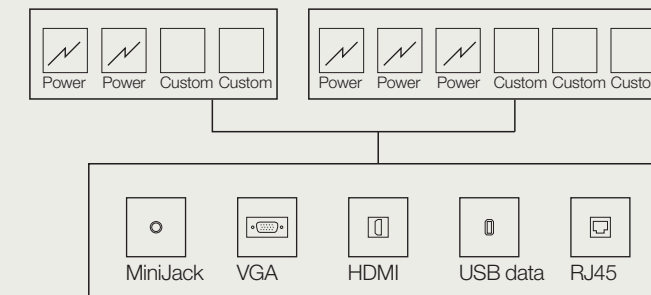

America

Closed

Wire management / Conectividad

America

Under top
Bajo sobre



Under table top connection system

Composed of a profile, in two finishes, black or white. Several sizes and configurations are available depending on the needs, 2 + 2 or 3 + 3, where 1 or 2 powers + 1 USB double charging are included, or if USB charging is not required 2 or 3 powers, and the rest are configurable being able to include minijack and USB, VGA, HDMI and USB, 2 USB data or 2 RJ45. There is also a 1 + 1 version for small tables consisting of 1 power and the remaining configurable with minijack and USB, VGA, HDMI and USB, 2 USB data, 2 RJ45 or 2 USB charging.

Sistema de conexiones bajo el sobre

Compuesto por un perfil, en dos acabados, negro o blanco. Se ofrecen varios tamaños y configuraciones dependiendo de las necesidades, 2+2 o 3+3, donde se incluyen 1 o 2 powers + 1 USB de carga doble, o si no se requiere USB de carga 2 o 3 powers, y los restantes son configurables pudiendo incluir minijack y USB, VGA, HDMI and USB, 2 USB de datos o 2 RJ45. También hay una versión de 1+1 para mesas pequeñas compuesto por 1 power y el restante configurable con minijack y USB, VGA, HDMI and USB, 2 USB de datos, 2 RJ45 o 2 USB de carga.



PS0755

PS0756

PS0750

PS0751

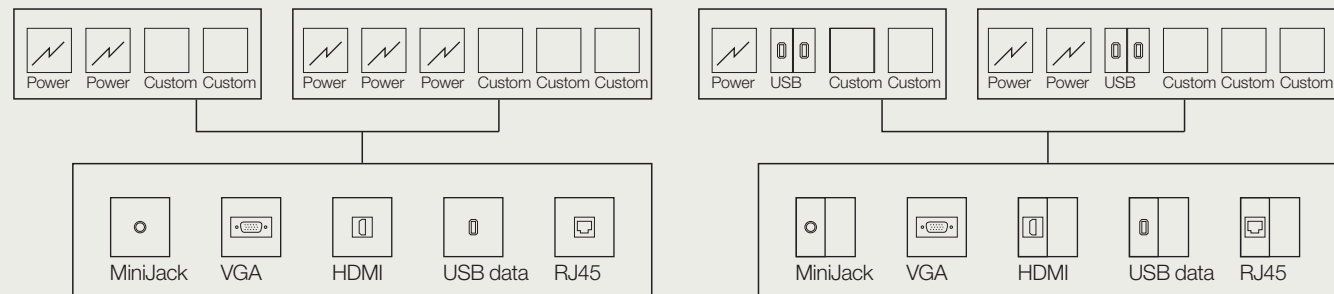

Wire management / Conectividad

America

Under top
Bajo sobre



Under table top USB charging system

Composed of 2 USB charging. It's available in two finishes, black and white.

Sistema de USB de carga bajo el sobre

Compuesto por 2 USB de carga. Está disponible en dos acabados, negro y blanco.

PS0715



In surface
En superficie



Qi charging system

Composed of a large surface for charging by induction, 1 power + 1USB charging (PS 0716) or 2USB charging (PS 0717). It is available in two finishes, black and white.

Sistema de carga Qi

Compuesto por una amplia superficie para cargar por inducción, 1 power+ 1USB de carga (PS 0716) o 2 USB de carga (PS 0717). Está disponible en dos acabados, negro y blanco.

In surface
En superficie



USB charging system

Composed of 2 USB charging. It is available in two finishes, black and white.

Sistema de carga USB

Compuesto por 2 USB de carga. Está disponible en dos acabados, negro y blanco.

PS0716 / PS0717



PS0718



Wire management / Conectividad

Europe / RoW

Distribution Distribución

- 1. System distribution:** As standard, the connection system will be located in the center of the table. For tables with more than one system, these will be placed with a separation of 1/3 of the total length of the table and in the longitudinal direction.
- 2. Wire management:** The cable leaves the power system, passes through an aluminum profile and travels down the leg.
- 3. Wiring outlet:** The cable exits directly from the connection system through an aluminum profile that hides the wiring and down the inside of the leg to reach the ground.

- 1. Distribución de sistemas:** De serie, el sistema de conexiones se dispondrá en el centro de la mesa. Para las mesas con más de un sistema, estos se colocarán con una separación de 1/3 de la longitud total de la mesa y en sentido longitudinal.
- 2. Gestión del cableado:** El cable sale del sistema de electrificación, pasa a través de un perfil de aluminio y baja por la pata.
- 3. Salida del cableado:** La salida del cable se realiza directamente desde el propio sistema de conexiones a través de un perfil de aluminio que oculta el cableado y baja por el interior de la pata hasta llegar al suelo.

PS0710
PS0720

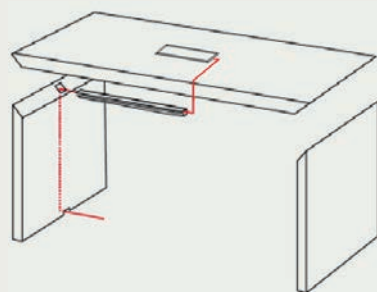

PS0787
PS0788

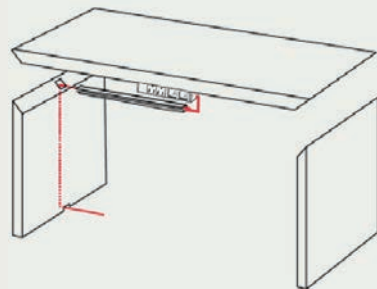

PS0789
PS0790

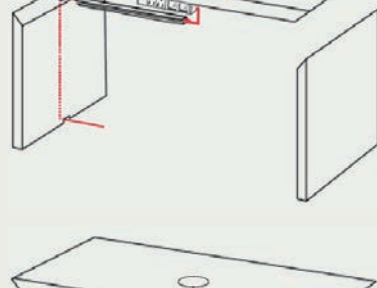

PS0714

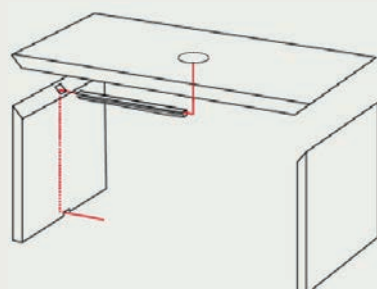

PS0784
PS0785

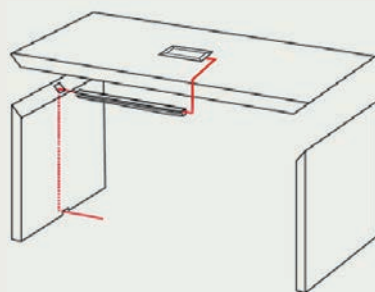

PS0715

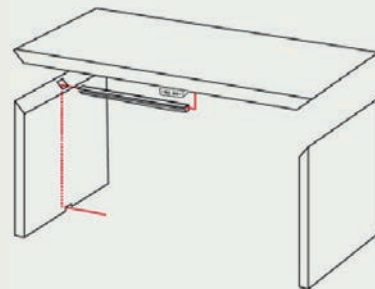

PS0718

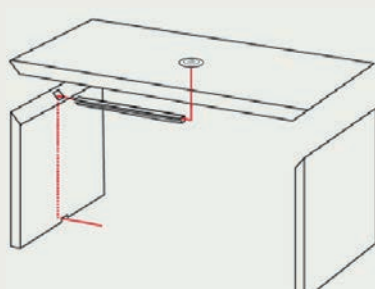

Wire management / Conectividad

Europe / RoW

In surface En superficie



Integrated connection system

Composed of an interior cover with the same finish as the table top, and exterior frame in matt black finish. Its opening is made on both sides. Two system sizes are available, configurable from 2 + 2 or 3 + 3 where 1 or 2 power ports are included depending on the choice + 1 USB charging port and the rest are configurable, and may include Minijack, VGA, HDMI, USB data ports or RJ45

Sistema de conexiones integrado

Compuesto por una tapa interior con el mismo acabado que el sobre y un marco exterior de acabado negro mate. Su apertura se realiza en ambos lados. Se ofrecen dos tamaños de sistemas, configurables de 2+2 o 3+3 donde se incluyen 1 o 2 powers dependiendo de la elección + 1 USB de carga y los restantes son configurables, pudiendo incluir Minijack, VGA, HDMI, USB de datos o RJ45.



PS0710

PS0720

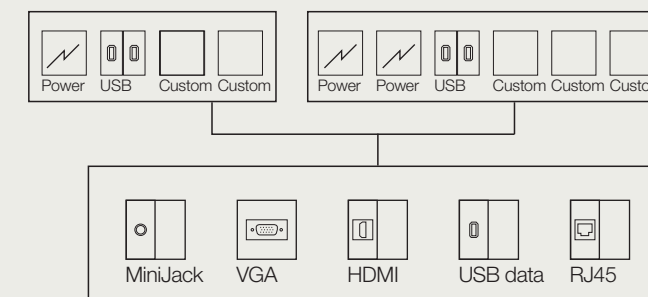

In surface En superficie



Integrated connection system

Composed of an interior cover with an exterior frame, both in anodized finish. Its opening is made by a soft touch. Two system sizes are available, configurable from 2 + 2 or 3 + 3 where 1 or 2 power ports are included depending on the choice + 1 USB charging port and the rest are configurable, and may include Minijack, VGA, HDMI, USB data ports or RJ45.

Sistema de conexiones en superficie

Compuesto por una tapa interior y un marco exterior, ambos en acabado anodizado. Su apertura se realiza con una suave pulsación. Se ofrecen 2 tamaños de sistemas, configurables 2+2 o 3+3 donde se incluyen 2 o 3 powers dependiendo de la elección, y los restantes son configurables, pudiendo incluir Minijack, VGA, HDMI, USB de datos o RJ 45.



PS0784

PS0785

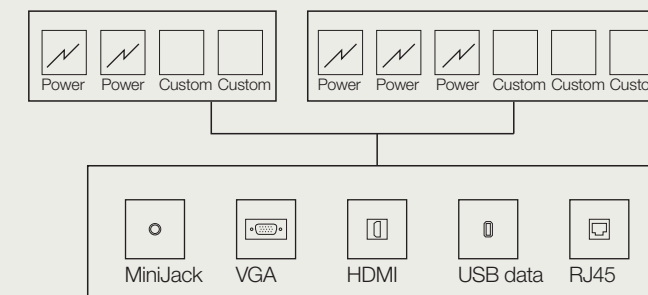

Wire management / Conectividad

Europe / RoW

Under top
Bajo sobre 

Under table top connection system

Composed of a profile, in two finishes, black or white. Several sizes and configurations are available depending on the needs, 2 + 2 or 3 + 3, where 1 or 2 powers + 1 USB double charging are included, or if USB charging is not required 2 or 3 powers, and the rest are configurable being able to include minijack and USB, VGA, HDMI and USB, 2 USB data or 2 RJ45. There is also a 1 + 1 version for small tables consisting of 1 power and the remaining configurable with minijack and USB, VGA, HDMI and USB, 2 USB data, 2 RJ45 or 2 USB charging.

Sistema de conexiones bajo el sobre

Compuesto por un perfil, en dos acabados, negro o blanco. Se ofrecen varios tamaños y configuraciones dependiendo de las necesidades, 2+2 o 3+3, donde se incluyen 1 o 2 powers + 1 USB de carga doble, o si no se requiere USB de carga 2 o 3 powers, y los restantes son configurables pudiendo incluir minijack y USB, VGA, HDMI and USB, 2 USB de datos o 2 RJ45. También hay una versión de 1+1 para mesas pequeñas compuesto por 1 power y el restante configurable con minijack y USB, VGA, HDMI and USB, 2 USB de datos, 2 RJ45 o 2 USB de carga.

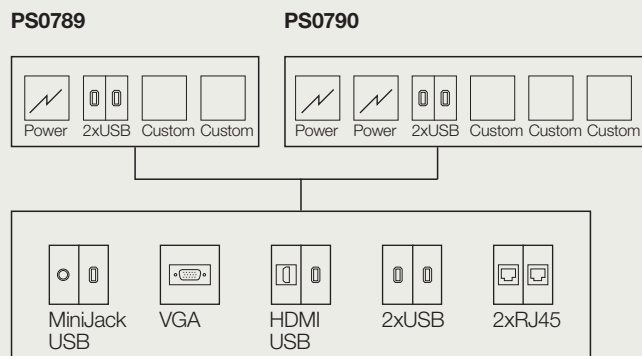
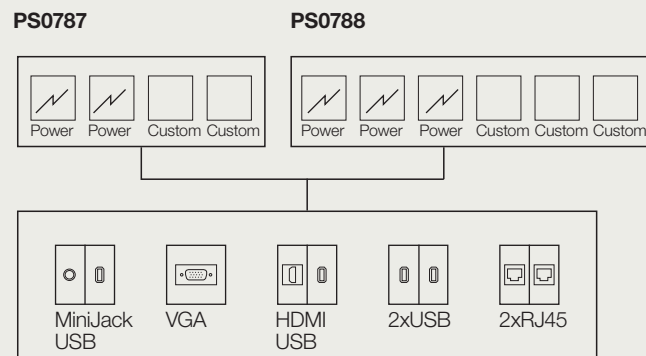

Wire management / Conectividad

Europe / RoW

Under top
Bajo sobre 

Under table top USB charging system

Composed of 2 USB charging. It's available in two finishes, black and white.

Sistema de USB de carga bajo el sobre

Compuesto por 2 USB de carga. Está disponible en dos acabados, negro y blanco.

PS0715



In surface
En superficie 

Qi charging system

Composed of a large surface for charging by induction. It is available in two finishes, black and white.

Sistema de carga Qi

Compuesto por una amplia superficie para cargar por inducción. Está disponible en dos acabados, negro y blanco.

In surface
En superficie 

USB charging system

Composed of 2 USB charging. It is available in two finishes, black and white.

Sistema de carga USB

Compuesto por 2 USB de carga. Está disponible en dos acabados, negro y blanco.

PS0714



PS0718



Extra is a table system developed to maximize the versatility of its materials, uses and adaptability to various installations. This resulted in a clear goal: a universal table that offers maximum functionality while maintaining its aesthetic value.

Extra es un sistema de mesas desarrollado desde la máxima versatilidad respecto a los materiales, los usos y su adaptación a todo tipo de ambientes. Es el resultado de una búsqueda concreta: una mesa universal que ofrezca siempre la máxima funcionalidad manteniendo su valor estético.

Extra Table

by Lievore Altherr Molina



Conference room

Sala de reunión

▼ ME8105 / SO1346

Table with oak board top and oak legs.

Mesa con sobre de tablero de roble y pies de roble.



Conference room
Sala de reunión

▼ **ME8175** / SO2017

Table with oak board top and
oak legs.

Mesa con sobre de tablero
de roble y pies de roble.



Conference room

Sala de reunión

▼ ME8411 / SI1200

Table with lacquered top and oak legs.

Mesa con sobre lacado y pies de roble lacadas.





Workspace

Espacio de trabajo

◀ **ME8411** / S1200

Table with lacquered top and oak legs.

Mesa con sobre lacado y pies de roble lacadas.

◀ **ME8108**

Table with oak top and aluminum delta legs.

Mesa con sobre de roble y pies delta de aluminio.

Workspace

Espacio de trabajo

▼ **ME8008** / SO2995

Table with lacquered top and aluminum delta legs.

Mesa con sobre lacado y pies delta de aluminio.



Extra Table



Extra Table

Conference room

Sala de reunión

▼ ME8280 / SO2999

Table with oak board top
and aluminum legs.

Mesa con sobre de
tablero de roble y pies de
aluminio.



▼ **ME01167**

Table with technical stone top and aluminum legs.
Mesa con sobre technical stone y pies de aluminio.

Conference room
Sala de reunión

► **ME01269** / BQ1590

Table with oak top and aluminum legs.
Mesa con sobre de roble y pies de aluminio.



Tops / Sobres

Table tops of different sizes in oak, lacquer, laminate, Technical Stone, Compacto HPL, glass, Calacatta marble, Carrara white marble and black marble bamboo. Connection box available.

Sobres de tablero de diferentes medidas en acabado roble, lacado, laminado, Technical Stone, Compacto HPL, cristal, mármol Calacatta, mármol blanco Carrara y mármol negro bambú. Disponible caja de conexiones.

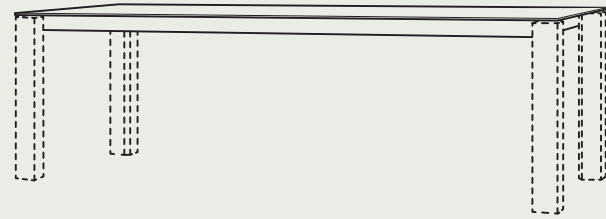

Oak Roble

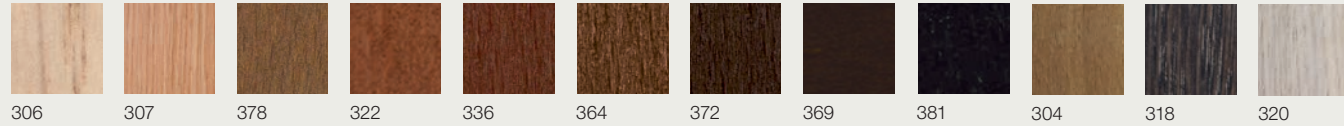

Premium finishes and wood lacquers Acabados premium y lacados



Laminate Laminado

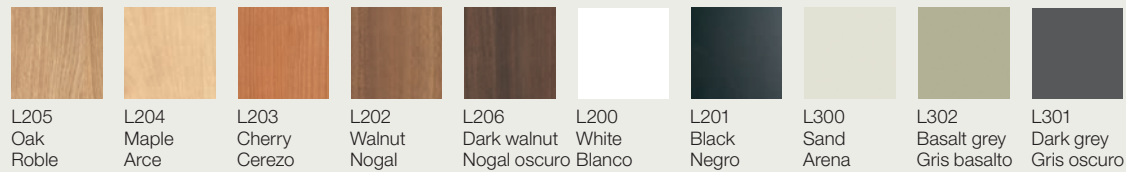

Glass Cristal

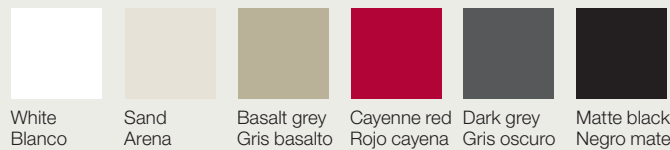

Technical stone



Compacto HPL

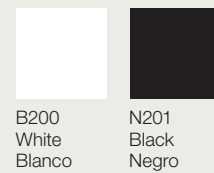

Linoleum Linóleo

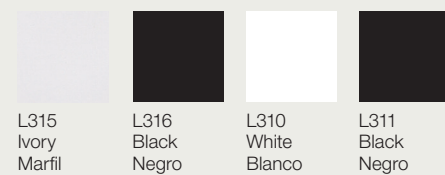

Ultra-matte Ultramate

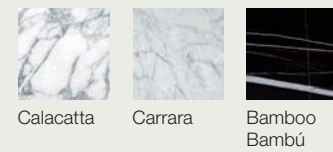

Marble top Sobres marmol

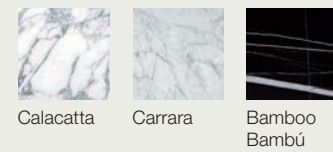

Legs / Pies

Table program available with different types of bases and table tops. Bases of 4 aluminum legs, with square or Delta shape, available in anodized brown, anodized silver, matte white and matte black, or 4 oak legs, with square form and available in 2 sizes.

Programa de mesas disponible con diferentes tipos de bases y sobres de mesa. Bases de 4 pies de aluminio, con forma cuadrada o delta, disponibles en acabado anodizado marrón, anodizado plata, blanco mate y negro mate, o de 4 pies de madera maciza de roble, con forma cuadrada y disponible en 2 medidas.



Wooden legs Pies madera

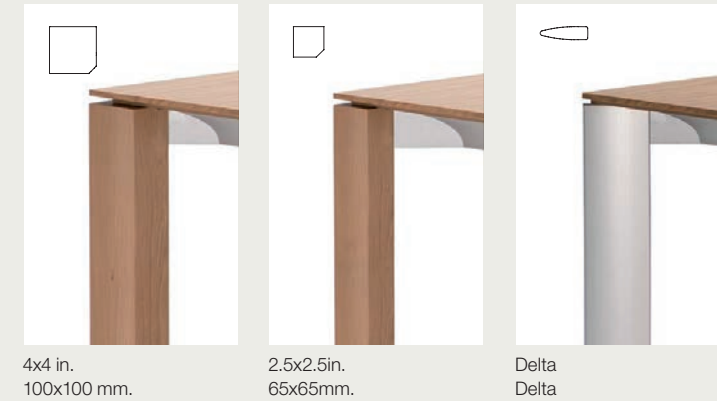

Aluminum legs Pies aluminio

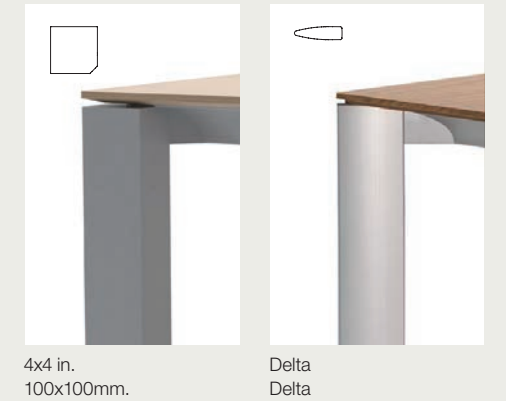

Aluminum Aluminio

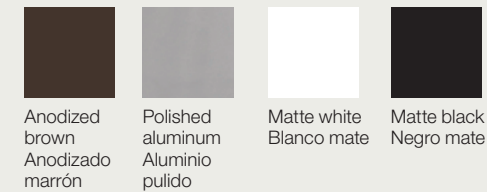

Oak Roble

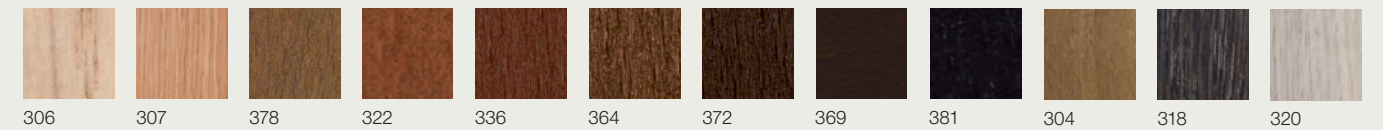

Premium finishes and wood lacquers Acabados premium y lacados

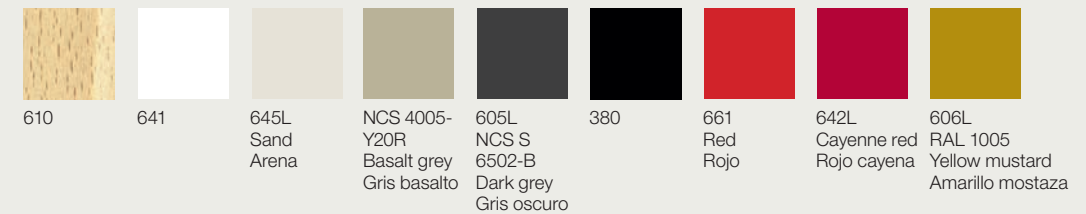

Meeting tables / Mesas de reunión

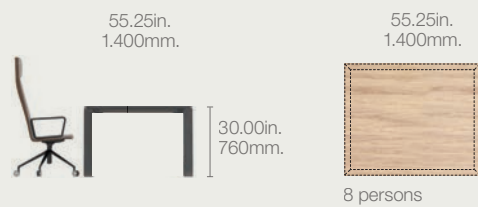
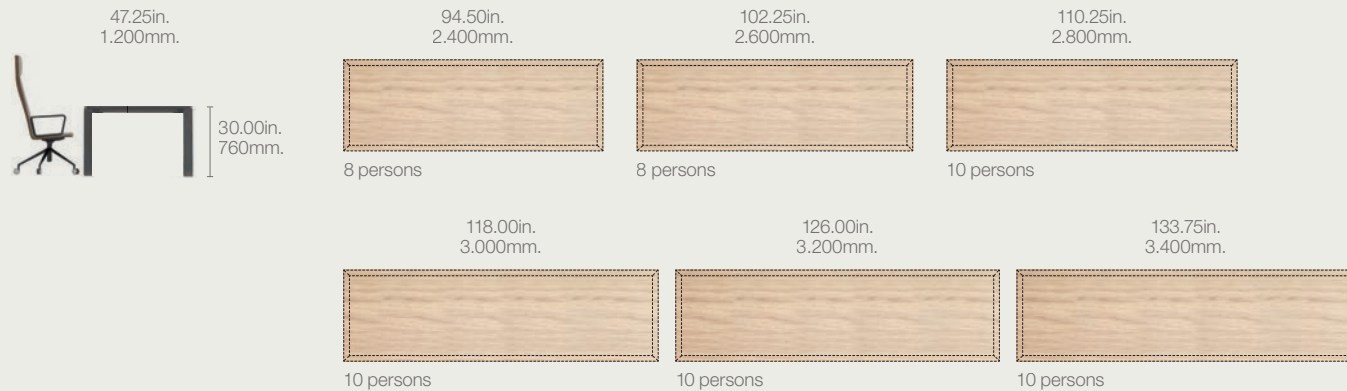
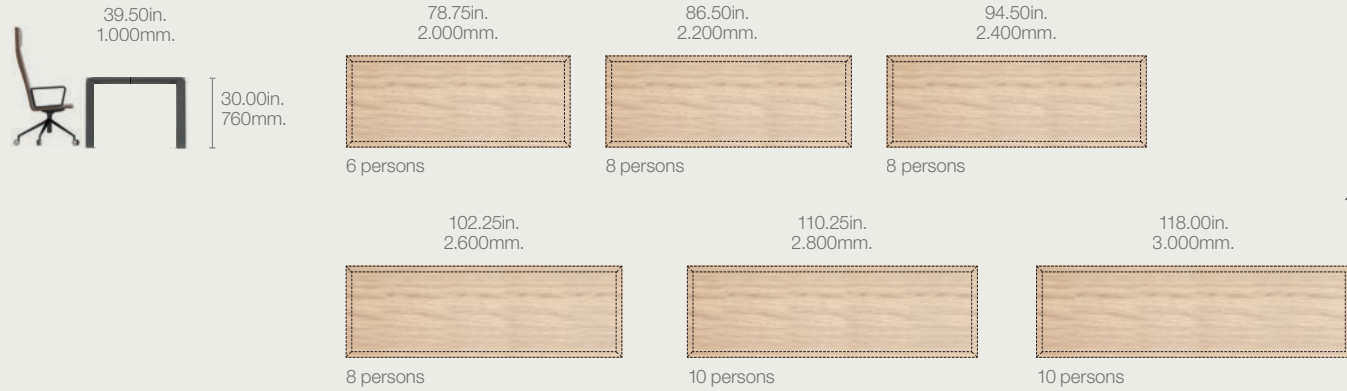

Extra table top / Sobres de mesa Extra

Top 18
 18 mm./0.75in. thick table top with bevelled edge.
 Sobre de mesa de 18mm./0.75in. de espesor con canto biselado.
 Oak / Roble
 Laminated / Laminado
 Lacquered / Lacado
 Linoleum / Linóleo
 Ultra-matte / Ultramate



Top Glass 10
 10mm/0.40in. thick table top, tempered glass, with optical glass version available. The total thickness of the table is 10 mm. glass + 12 mm. compact HPL.
 Sobre de mesa de 10mm/0.40in. de espesor, de vidrio templado, con versión de cristal óptico disponible. El grosor total de la mesa es de 10 mm. vidrio + 12 mm. Compacto HPL.



Top Technical Stone
 6mm./0.25in. technical stone table top.
 6mm. /0.25in. Sobre Technical stone.



Top Compacto HPL
 12mm/0.50in. thick table top, composed of a compact center high pressure laminate (HPL).
 Sobre de mesa de 12mm/0.50in. de espesor, compuesto por un laminado de alta presión de centro compacto (HPL)



Top 20 Marble Razor
 20mm/0.80in. marble table top with bevelled edge.
 Sobre de mesa de mármol de 20mm/0.80in. de espesor con canto biselado



Top 20 Marble Square
 20mm/0.80in. marble table top.
 Sobre de mesa de mármol de 20mm/0.80in. de espesor



Tops / Sobres

Table tops of different sizes in oak, lacquer, laminate, Technical Stone, Compact HPL, Glass, Calacatta marble, Carrara white marble and black marble bamboo. Connection box available.

Sobres de tablero de diferentes medidas en acabado roble, lacado, laminado, Technical Stone, Compact HPL, Cristal, mármol Calacatta, mármol blanco Carrara y mármol negro bambú. Disponible caja de conexiones.

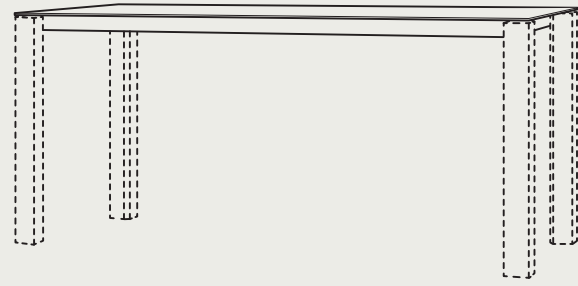

Oak Roble



306 307 378 322 336 364 372 369 381 304 318 320

Premium finishes and wood lacquers Acabados premium y lacados



610 641 645L Sand Arena NCS 4005-Y20R Basalt grey Gris basalto 605L NCS S 6502-B Dark grey Gris oscuro 380 661 Red Rojo 642L Cayenne red Rojo cayena 606L RAL 1005 Yellow mustard Amarillo mostaza

Laminate Laminado



L205 Oak Roble L204 Maple Arce L203 Cherry Cerezo L202 Walnut Nogal L206 Dark walnut Nogal oscuro L200 White Blanco L201 Black Negro L300 Sand Arena L302 Basalt grey Gris basalto L301 Dark grey Gris oscuro

Glass Cristal



White Blanco Sand Arena Basalt grey Gris basalto Cayenne red Rojo cayena Dark grey Gris oscuro Matte black Negro mate

Technical stone



Earth brown Marrón tierra Sand grey Gris piedra Stone grey Gris piedra

Marble top Sobres marmol

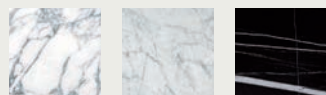

Calacatta Carrara

Compacto HPL



B200 White Blanco N201 Black Negro

Technical stone 8

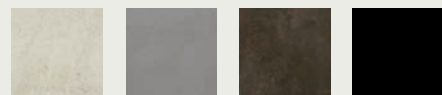

DKAR Sand Arena DKRC Rock grey Gris roca DKMR Earth brown Marrón tierra DKNG Black Negro

Linoleum Linóleo

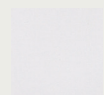

L315 Ivory Marfil

Ultra-matte Ultramate



L316 Black Negro L310 White Blanco L311 Black Negro

Legs / Pies

Table program available with different types of bases and table tops. Bases of 4 aluminum legs, with square available in anodized brown, anodized silver, matte white and matte black.

Programa de mesas disponible con diferentes tipos de bases y sobres de mesa. Bases de 4 pies de aluminio con forma cuadrada en acabado anodizado marrón, anodizado plata, blanco mate y negro mate.



Aluminum legs Pies aluminio



4x4 in.
100x100mm.



Aluminum Aluminio



Anodized brown Anodizado marrón Polished aluminum Aluminio pulido Matte white Blanco mate Matte black Negro mate

Meeting tables / Mesas de reunión

Top 18

18 mm./0.75in. thick table top with bevelled edge.
Sobre de mesa de 18mm./0.75in. de espesor con canto biselado.

Oak / Roble
Laminated / Laminado
Lacquered / Lacado
Linoleum / Linóleo
Ultra-matte / Ultramate



Top Glass 10

10mm/0.40in. thick table top, tempered glass, with optical glass version available. The total thickness of the table is 10 mm. glass + 12 mm. compact HPL.
Sobre de mesa de 10mm/0.40in. de espesor, de vidrio templado, con versión de cristal óptico disponible. El grosor total de la mesa es de 10 mm. vidrio + 12 mm. Compacto HPL.



Top Technical Stone

8mm./0.30in. technical stone table top.
8mm. /0.30in. Sobre Technical stone.



Extra table top / Sobres de mesa Extra

Top Compacto HPL

12mm/0.50in. thick table top, composed of a compact center high pressure laminate (HPL).
Sobre de mesa de 12mm/0.50in. de espesor, compuesto por un laminado de alta presión de centro compacto (HPL)

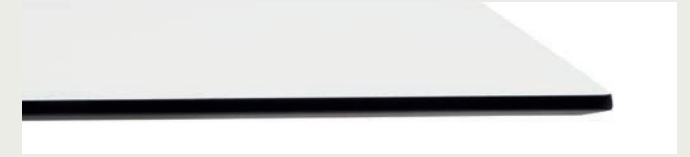

Top 20 Marble Square

20mm/0.80in. marble table top.
Sobre de mesa de mármol de 20mm/0.80in. de espesor



Meeting tables / Mesas de reunión

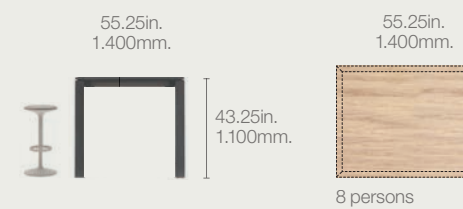
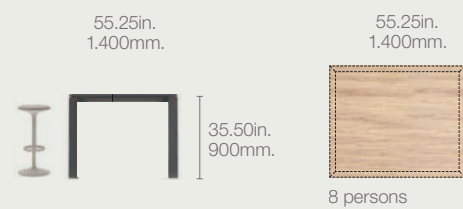
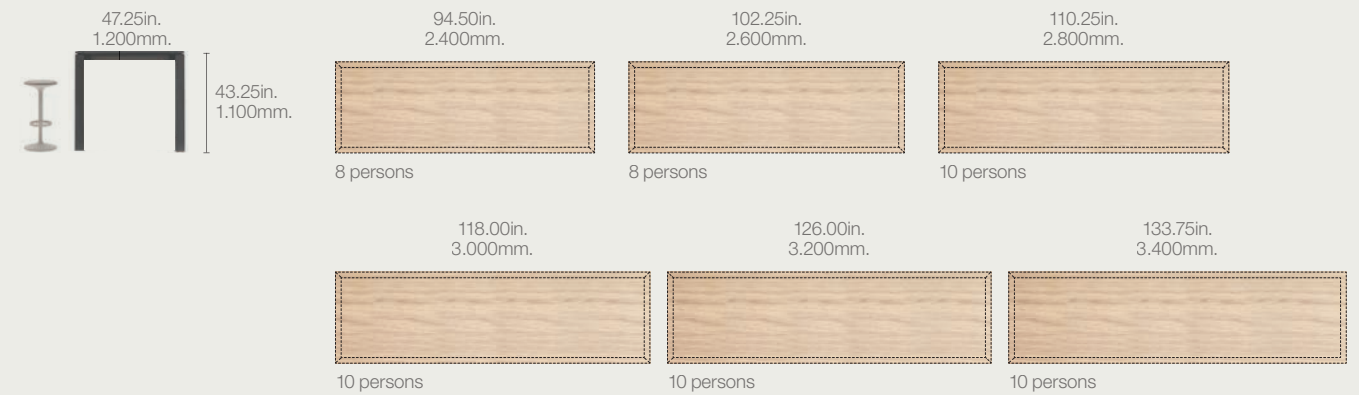
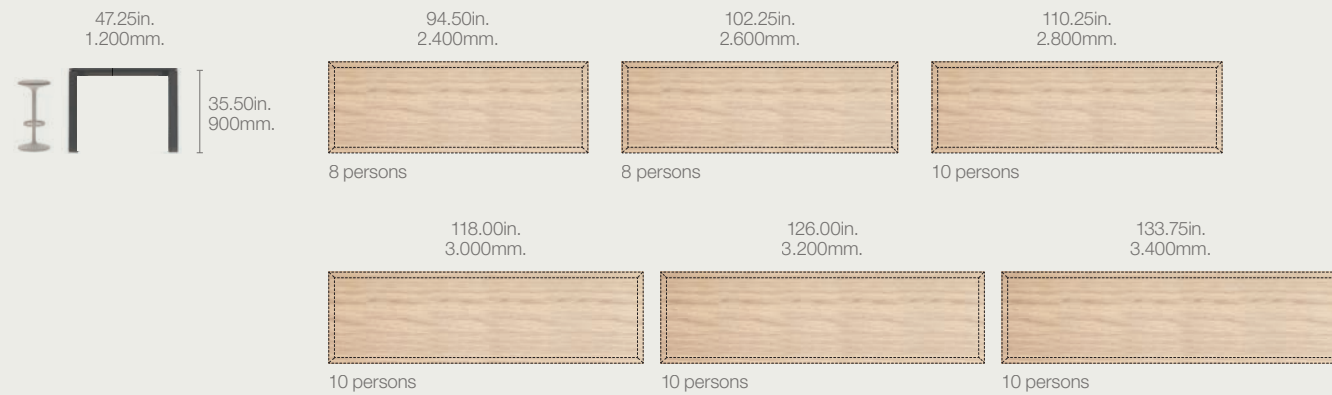
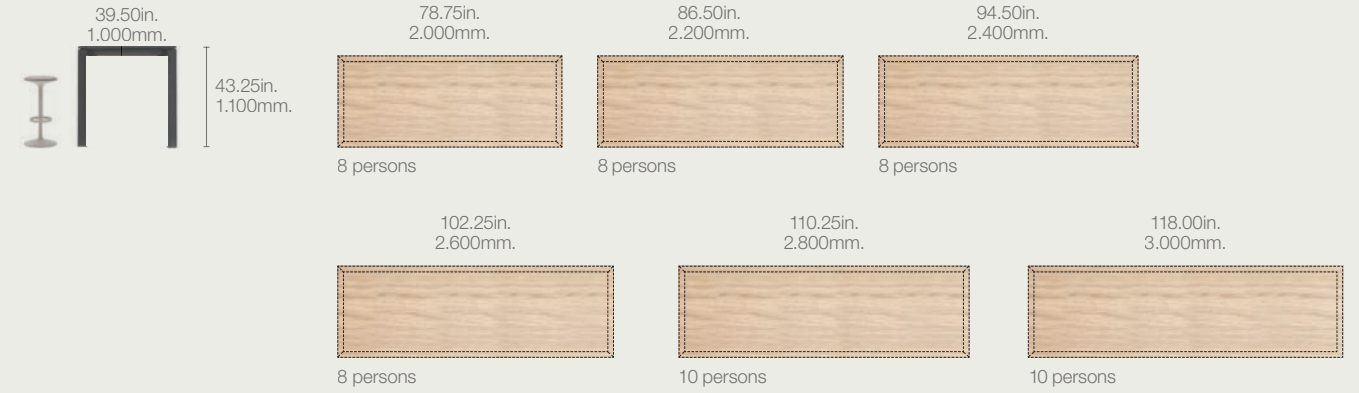
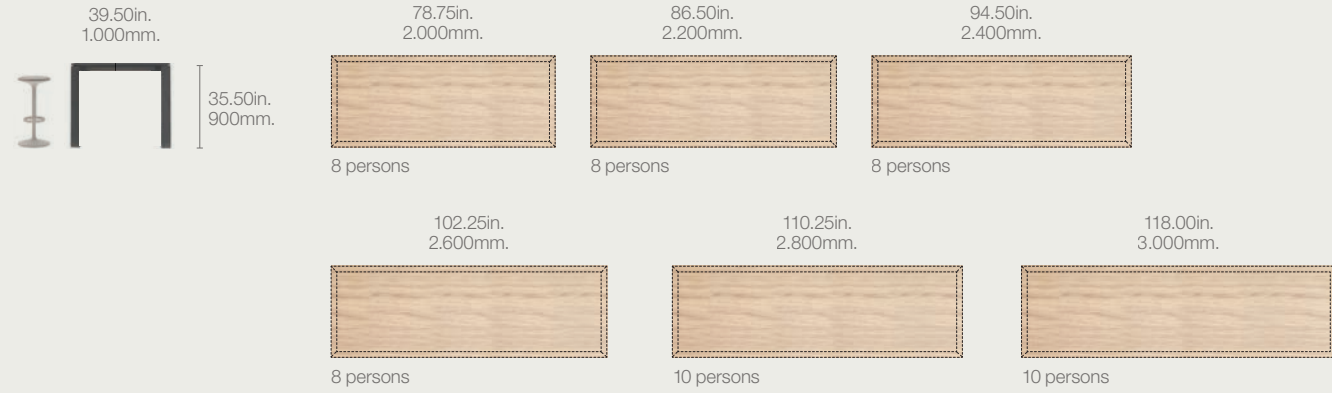
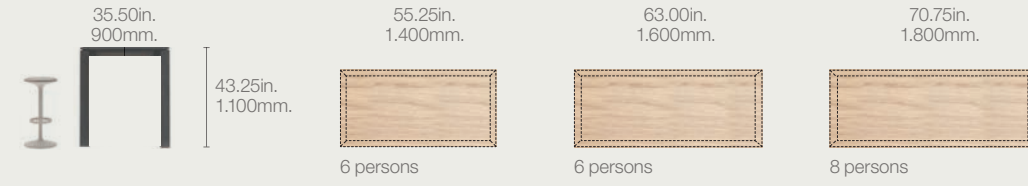

Wire management / Conectividad

America

Distribution Distribución

1. System distribution: As standard, the connection system will be located in the center of the table. For tables with more than one system, these will be placed with a separation of 1/3 of the total length of the table and in the longitudinal direction.

2. Wire management: The cable leaves the power system, passes through an aluminum profile and travels down the leg.

3. Wiring exit: The cable exits directly from the power system or through an aluminum frame so that it is concealed at the bottom of the base. The cable then crosses the aluminum profiles of the legs and is completely hidden until it reaches the floor.

1. Distribución de sistemas: De serie, el sistema de conexiones se dispondrá en el centro de la mesa. Para las mesas con más de un sistema, estos se colocarán con una separación de 1/3 de la longitud total de la mesa y en sentido longitudinal.

2. Gestión del cableado: El cable sale del sistema de electrificación, pasa a través de un perfil de aluminio y baja por la pata metálica.

3. Salida del cableado: La salida del cable se realiza directamente desde el propio sistema de conexiones a través de un perfil de aluminio que oculta el cableado y baja por el interior de la pata metálica hasta llegar al suelo.

PS 0711
PS 0721

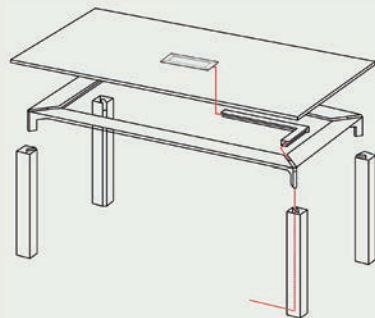
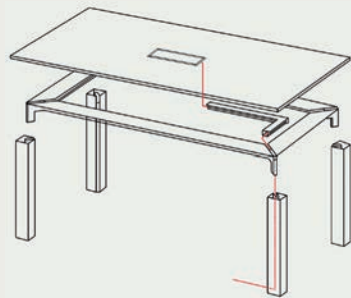

PS 0752
PS 0753

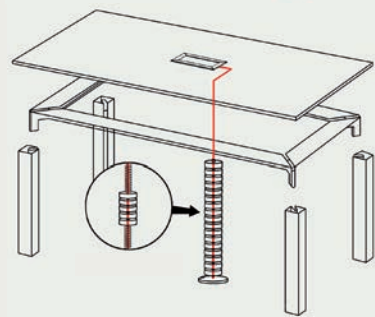

Hard wired,
applicable to PS
0752 and PS 0753
They are offered as
an extra option.
Hard wired, aplicable
a PS 0752 y PS 0753
Se ofrecen como
una opción extra.

PS 0713

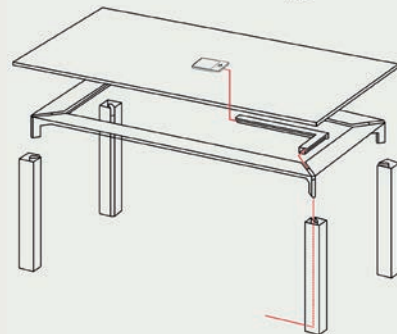
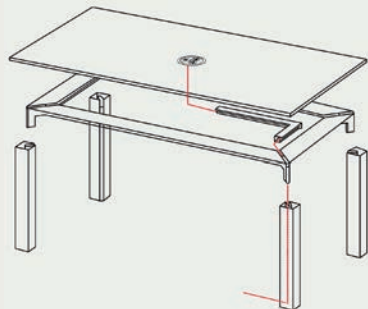

PS 0716
PS 0717

PS 0718

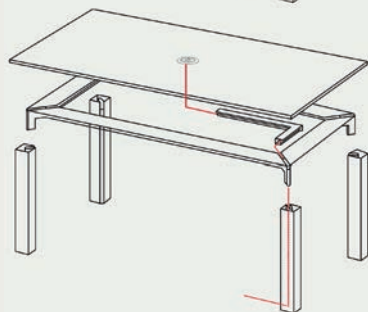

Wire management / Conectividad

America

In surface En superficie



Integrated connection system

Composed of an interior cover with the same finish as the table top, and exterior frame in matt black finish. Its opening is made on both sides. Two system sizes are available, configurable from 2 + 2 or 3 + 3 where 1 or 2 power ports are included depending on the choice + 1 USB charging port and the rest are configurable, and may include MiniJack, VGA, HDMI, USB data ports or RJ45.

Sistema de conexiones integrado

Compuesto por una tapa interior con el mismo acabado que el sobre y un marco exterior de acabado negro mate. Su apertura se realiza en ambos lados. Se ofrecen dos tamaños de sistemas, configurables de 2+2 o 3+3 donde se incluyen 1 o 2 powers dependiendo de la elección + 1 USB de carga y los restantes son configurables, pudiendo incluir MiniJack, VGA, HDMI, USB de datos o RJ45.



PS0711

PS0721

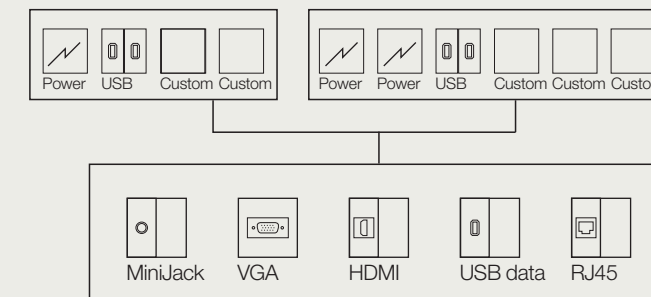

In surface En superficie



Integrated connection system

Composed of an interior cover with an exterior frame, both in anodized finish. Its opening is made by a soft touch. Two system sizes are available, configurable from 2 + 2 or 3 + 3 where 2 or 3 power ports are included depending on the choice and the rest are configurable, and may include MiniJack, VGA, HDMI, USB data ports or RJ45.

Sistema de conexiones en superficie

Compuesto por una tapa interior y un marco exterior, ambos en acabado anodizado. Su apertura se realiza con una suave pulsación. Se ofrecen 2 tamaños de sistemas, configurables 2+2 o 3+3 donde se incluyen 2 o 3 powers dependiendo de la elección, y los restantes son configurables, pudiendo incluir MiniJack, VGA, HDMI, USB de datos o RJ 45.



PS0752

PS0753

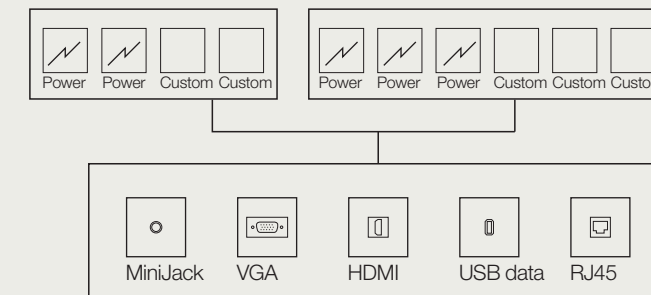

Wire management / Conectividad

In surface
En superficie 

Integrated connection system

Composed of 2 powers and 2 USB charging. The system turns on itself and remains hidden when it is not in use. It is available in two finishes, black and white.

Sistema de conexiones integrado

Compuesto por 2 powers y 2 USB de carga. El sistema gira sobre si mismo y permanecer oculto cuando no este en uso. Está disponible en dos acabados, negro y blanco.

PS 0713



In surface
En superficie 

USB charging system

Composed of 2 USB charging. It is available in two finishes, black and white.

Sistema de carga USB

Compuesto por 2 USB de carga . Está disponible en dos acabados, negro y blanco.

PS 0718



America

In surface
En superficie 

Qi charging system

Composed of a large surface for charging by induction, 1 power + 1USB charging (PS 0716) or 2USB charging (PS 0717). It is available in two finishes, black and white.

Sistema de carga Qi

Compuesto por una amplia superficie para cargar por inducción , 1 power+ 1USB de carga (PS 0716) o 2 USB de carga (PS 0717). Está disponible en dos acabados, negro y blanco.

PS 0716 / PS 0717



Wire management / Conectividad

Europe / RoW

Distribution
Distribución

1. System distribution: As standard, the connection system will be located in the center of the table. For tables with more than one system, these will be placed with a separation of 1/3 of the total length of the table and in the longitudinal direction.

2. Wire management: The cable leaves the power system, passes through an aluminum profile and travels down the leg.

3. Wiring exit: The cable exits directly from the connection system through an aluminum profile that hides the wiring and travels down inside the metal leg, if it is a wooden leg, it will be pre-machined, so that the wiring goes through it, until it reaches the ground.

1. Distribución de sistemas: De serie, el sistema de conexiones se dispondrá en el centro de la mesa. Para las mesas con más de un sistema, estos se colocarán con una separación de 1/3 de la longitud total de la mesa y en sentido longitudinal.

2. Gestión del cableado: El cable sale del sistema de electrificación, pasa a través de un perfil de aluminio y baja por la pata metálica.

3. Salida del cableado: La salida del cable se realiza directamente desde el propio sistema de conexiones a través de un perfil de aluminio que oculta el cableado y baja por el interior de la pata metálica hasta llegar al suelo.

PS 0710
PS 0720

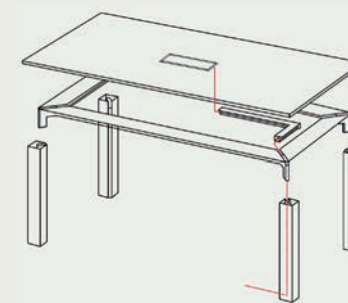

PS 0784
PS 0785

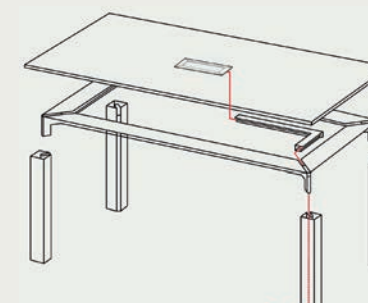

PS 0714

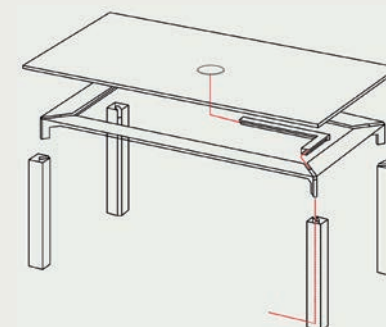

PS 0718

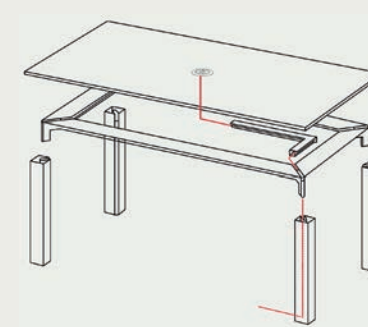

Wire management / Conectividad

Europe / RoW

In surface
En superficie 

Integrated connection system

Composed of an interior cover with the same finish as the table top, and exterior frame in matt black finish. Its opening is made on both sides. Two system sizes are available, configurable from 2 + 2 or 3 + 3 where 1 or 2 power ports are included depending on the choice + 1 USB charging port and the rest are configurable, and may include MiniJack, VGA, HDMI, USB data ports or RJ45.

Sistema de conexiones integrado

Compuesto por una tapa interior con el mismo acabado que el sobre y un marco exterior de acabado negro mate. Su apertura se realiza en ambos lados. Se ofrecen dos tamaños de sistemas, configurables de 2+2 o 3+3 donde se incluyen 1 o 2 powers dependiendo de la elección + 1 USB de carga y los restantes son configurables, pudiendo incluir MiniJack, VGA, HDMI, USB de datos o RJ45.



PS 0710

PS 0720

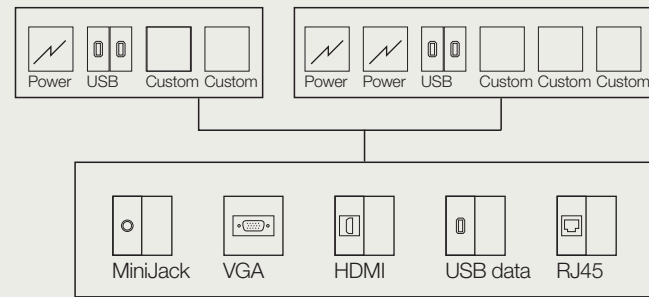

In surface
En superficie 

Surface Connection system

Composed of an interior cover with an exterior frame, both in anodized finish. Its opening is made by a soft touch. Two system sizes are available, configurable from 2 + 2 or 3 + 3 where 2 or 3 power ports are included depending on the choice and the rest are configurable, and may include MiniJack, VGA, HDMI, USB data ports or RJ45.

Sistema de conexiones en superficie

Compuesto por una tapa interior y un marco exterior, ambos en acabado anodizado. Su apertura se realiza con una suave pulsación. Se ofrecen 2 tamaños de sistemas, configurables 2+2 o 3+3 donde se incluyen 2 o 3 powers dependiendo de la elección, y los restantes son configurables, pudiendo incluir MiniJack, VGA, HDMI, USB de datos o RJ 45.



PS 0784

PS 0785

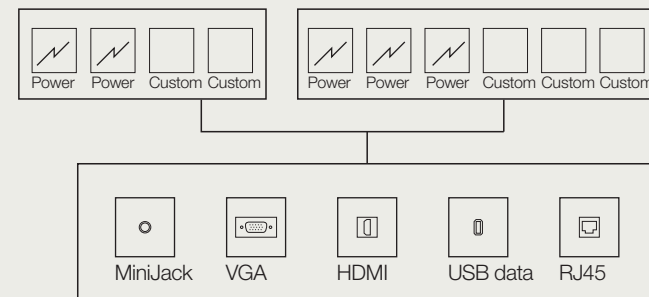

Wire management / Conectividad

Europe / RoW

In surface
En superficie 

Qi charging system

Composed of a large surface for charging by induction, It is available in two finishes, black and white.

Sistema de carga Qi

Compuesto por una amplia superficie para cargar por inducción. Está disponible en dos acabados, negro y blanco.

In surface
En superficie 

USB charging system

Composed of 2 USB charging. It is available in two finishes, black and white.

Sistema de carga USB

Compuesto por 2 USB de carga. Está disponible en dos acabados, negro y blanco.

PS 0714



PS 0718



This program of tables, developed from an elaborate and synthetic geometry, is the epitome of versatility and adaptation to a multitude of environments and workspaces. Radial Conference Table is characterized by its modularity and technology. Its architectural design and distinct technological character adapts to numerous combinations, offering power management integrated into the table's frame.

Este programa de mesas, desarrollado a partir de una geometría trabajada y sintética, es el paradigma de la versatilidad y la adaptación a multitud de entornos y espacios de trabajo. Radial Conference Table se caracteriza por su modularidad y tecnificación. Su diseño arquitectónico y de marcado carácter tecnológico se adapta a multitud de combinaciones, ofreciendo una gestión de las conexiones integradas a su estructura.

Radial Conference Table

by Estudio Andreu

Conference room

Sala de reuniones

▼ ME9072 / SO1846

Table with aluminum legs in black finish with oak top.

Mesa con pies de aluminio acabadas en negro con sobre de roble.



► **ME9330** / SI1300

Table with aluminum legs in white finish with lacquered top.
Mesa con pies de aluminio acabadas en blanco con sobre lacado.

▼ **ME9168** / SI1840

Table with aluminum legs in black finish with oak top.
Mesa con pies de aluminio acabadas en negro con sobre de roble.



Conference room
Sala de reunión

▼ **ME9195** / SO1532

Table with aluminum legs in white finish with lacquered top.
Mesa con pies de aluminio acabadas en blanco con sobre lacado.



Workspace
Zona de trabajo
▼ **ME95893** / S11555
Table with oak board top and
aluminum legs in oak finish.
Mesa con sobre de tablero
de roble y pies de aluminio
acabadas en roble.



Workspace
Zona de trabajo

► **ME95131** / BQ1332

High table. Table with aluminum legs in black finish with laminate top.

Mesa alta. Mesa con pies de aluminio acabadas en negro con sobre laminado.

▼ **ME95056** / BQ1312

High table. Table with aluminum legs in white finish with lacquered top.

Mesa alta. Mesa con pies de aluminio acabadas en blanco con sobre lacado.



Workspace
Zona de trabajo

▼ **ME95125** / BQ1332

High table. Table with aluminum legs in black finish with oak top.

Mesa alta. Mesa con pies de aluminio acabadas en negro con sobre de roble.

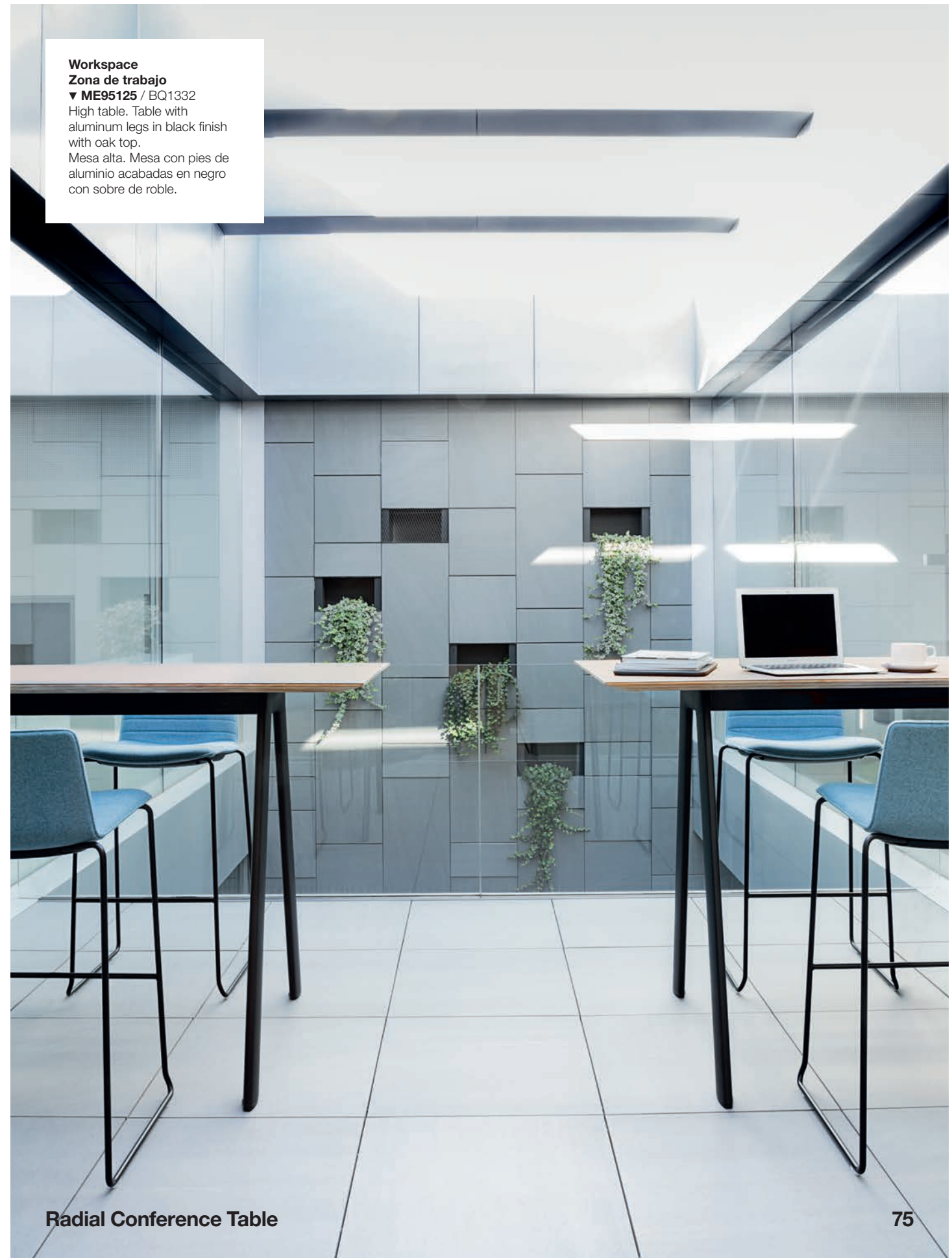

Tops / Sobres

The Radial table tops are available in different materials and finishes from oak, lacquered, laminate, HPL and glass, to linoleum and ultra-matte.

Los sobres de la mesa Radial se ofrecen en diferentes materiales y acabados desde el Roble, Lacado, Laminado, HPL y Cristal, hasta Linóleo y Ultramate.

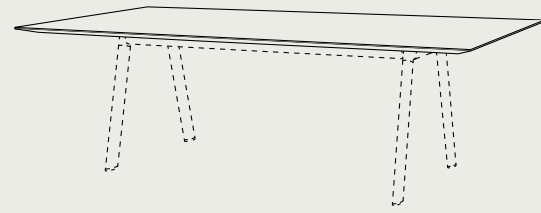

Oak Roble

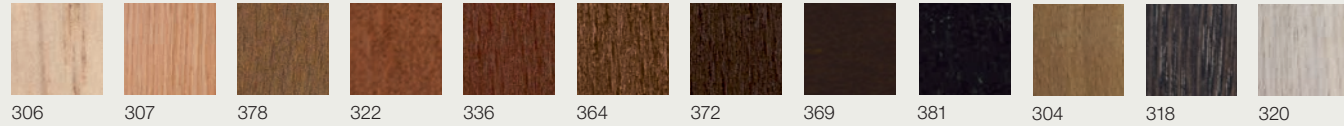

Premium finishes and wood lacquers Acabados premium y lacados



Cement Cemento

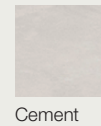

Laminate / Laminado TP Laminado / Laminado TP

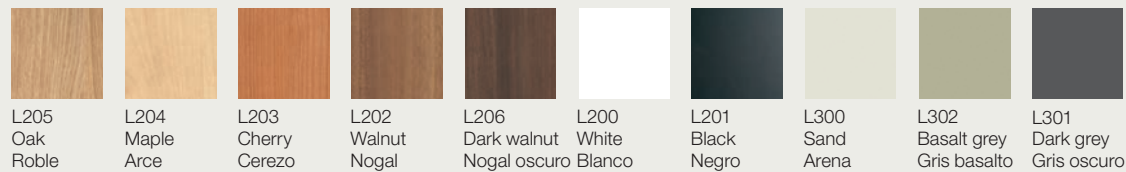

Glass Cristal

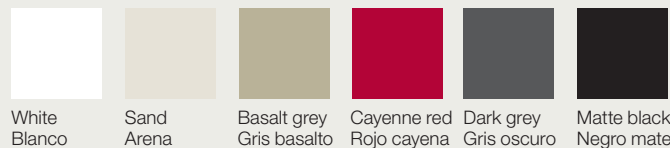

Linoleum Linóleo

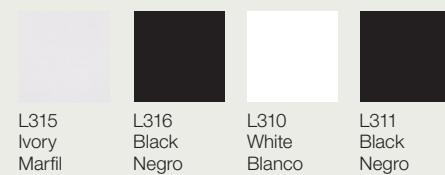

Ultra-matte Ultramate

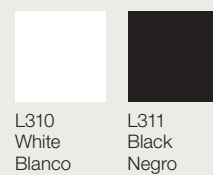

Top 30 Square

30mm./1.18in. thick table top, laminated and with straight edge. Sobre de mesa de 30mm./1.18in. de espesor, laminado y con canto recto.

Oak / Roble
Laminated TP / Laminado TP
Lacquered / Lacado
Linoleum / Linóleo
Ultra-matte / Ultramate



Tops / Sobres

Top 30 Razor

30mm./1.18in. thick table top and bevelled edge. Sobre de mesa de 30mm./1.18in. de espesor y con canto biselado.

Oak / Roble- Technical stone 8
Laminated / Laminado
Lacquered / Lacado
Linoleum / Linóleo
Ultra-matte / Ultramate
Cement / Cemento

Top 30 Razor TP

30mm./1.18in. thick table top and matching thermopolymer bevelled edge. Sobre de mesa de 30mm./1.18in. de espesor y con canto de termopolimero a juego.

Laminated TP / Laminado TP
Ultra-matte TP / Ultramate TP

Top Glass 35

36mm./1.4in. thick table top, with 6mm./0.2in. tempered glass + 30mm./1.2in. substrate. Sobre de mesa de 36mm./1.4in. de espesor, con cubierta de cristal templado de 6mm./0.2in. + sustrato de 30mm./1.2in.



Legs / Pies

The legs of the Radial table, made of extruded aluminum, are available in white, black, polished and anodized, in addition to the oak version.

Las pies de la mesa Radial, realizadas en aluminio extruido se ofrecen en acabado blanco, negro, pulido y anodizado ademas de la version de madera de roble.

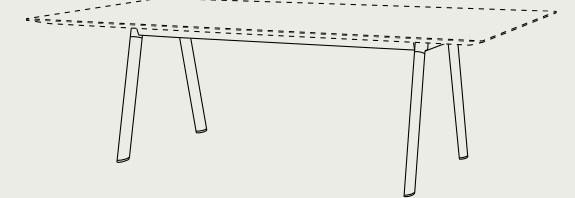

Aluminum Aluminio

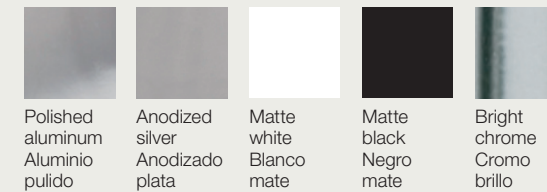

Oak Roble

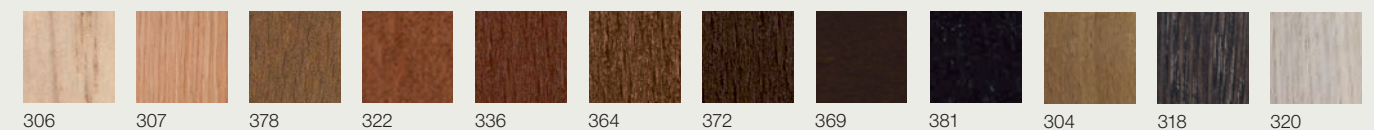

Premium finishes and wood lacquers Acabados premium y lacados



Meeting tables / Mesas de reunión

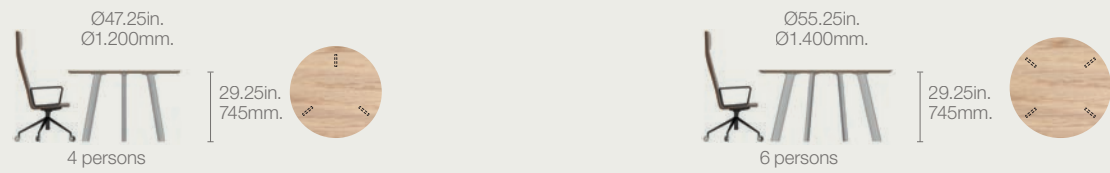
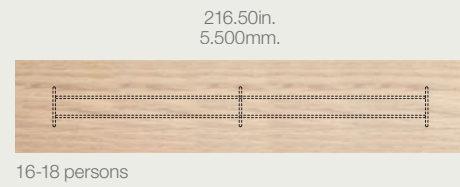
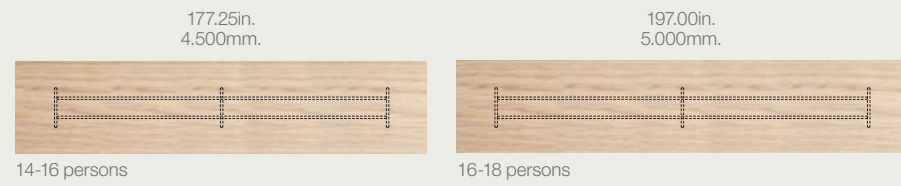
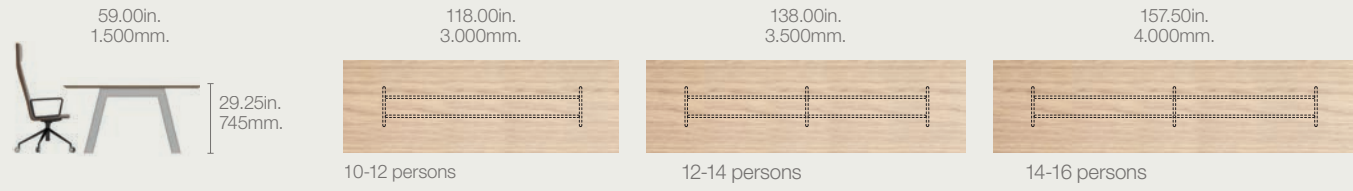
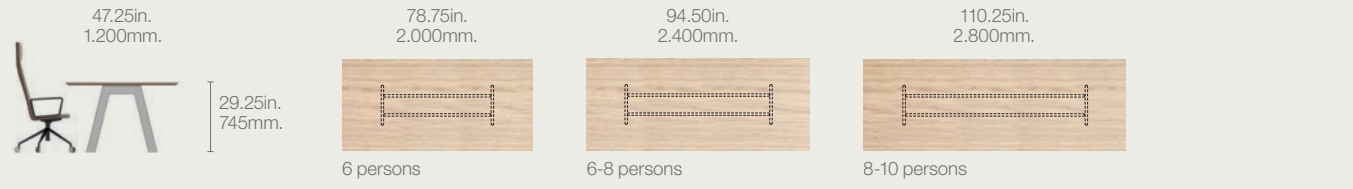

High tables / Mesas altas

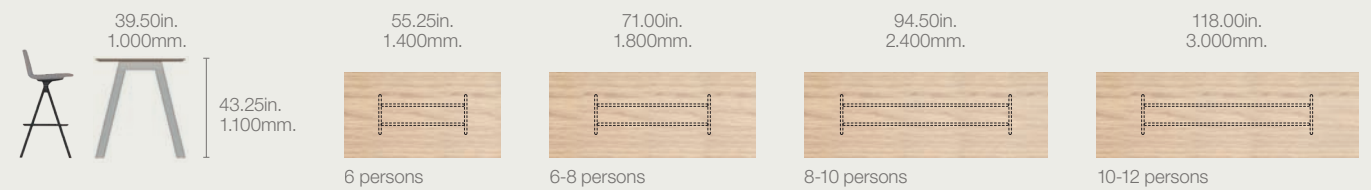
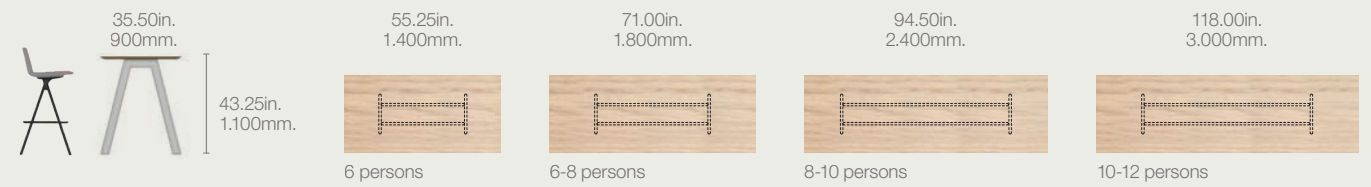
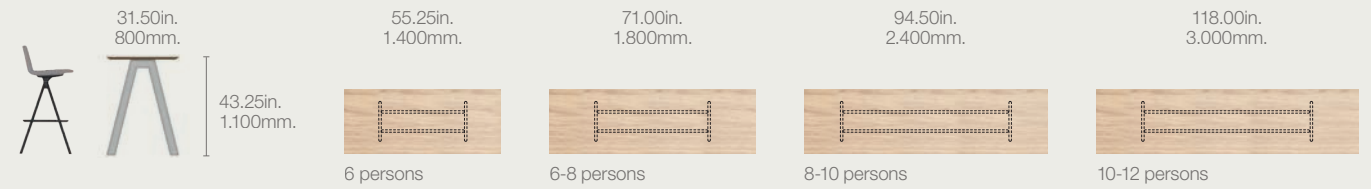
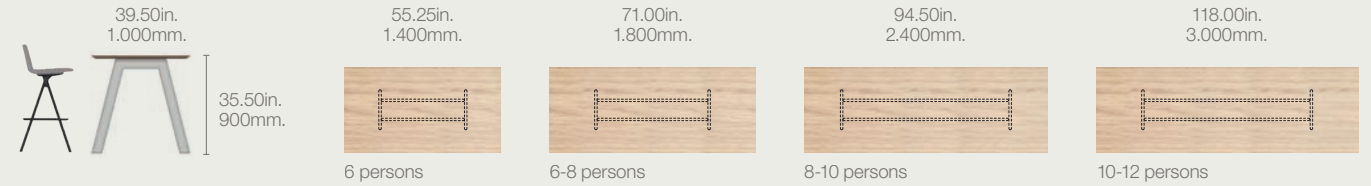
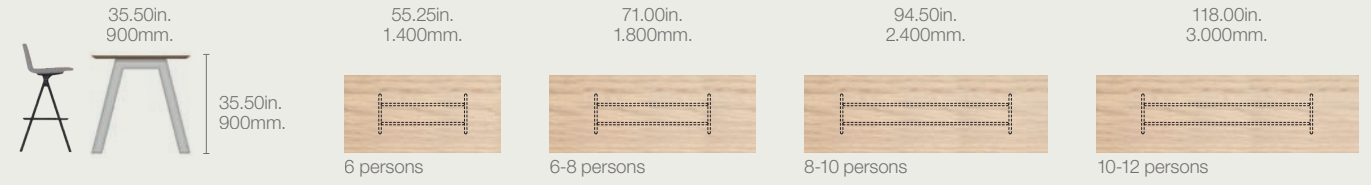
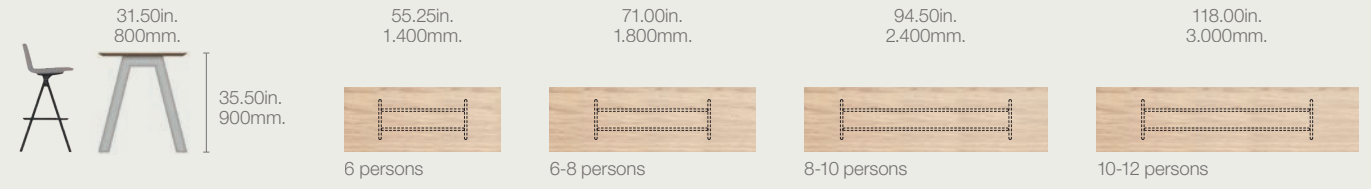

Wire management / Conectividad

America

Distribution Distribución

1. Power boxes distribution: By standard, the power/data box would be offset relative to the base. For tables with more than one power box, these will be separated 1/3 between them and placed horizontally and longitudinally.

2. Wire management: The cable passes through an aluminum wire manager, keeping it hidden from the users.

3. Wiring exit: the cable exits directly from the power system or through an aluminum frame so that it is concealed at the bottom of the base. The cable then crosses the aluminum profiles of the legs and is completely hidden until it reaches the floor.

1. Distribución de sistemas: De serie, el sistema de conexiones se dispondrá en el centro de la mesa. Para las mesas con más de un sistema, estos se colocarán con una separación de 1/3 de la longitud total de la mesa y en sentido longitudinal.

2. Gestión del cableado: El cable sale del sistema de electrificación, pasa a través del perfil de aluminio lateral y baja por la pata.

3. Salida del cableado: La salida del cable se realiza directamente desde el propio sistema de conexiones a través del perfil de aluminio lateral, que oculta el cableado y baja por el interior de la pata hasta llegar al suelo.

PS0711
PS0721

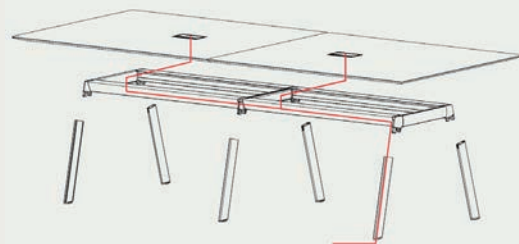
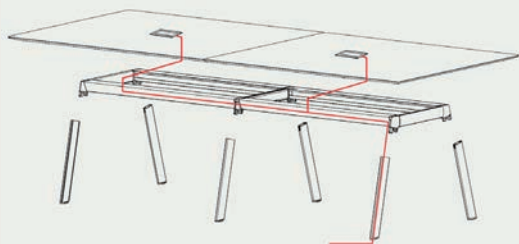

PS0752
PS0753

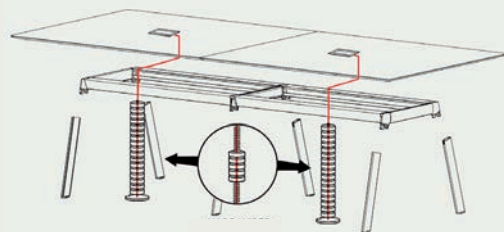

Hard wired,
applicable to PS
0752 and PS 0753
They are offered as
an extra option.
Hard wired, aplicable
a PS 0752 y PS 0753
Se ofrecen como
una opción extra.

PS0755
PS0756

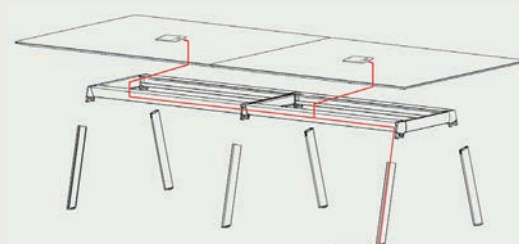
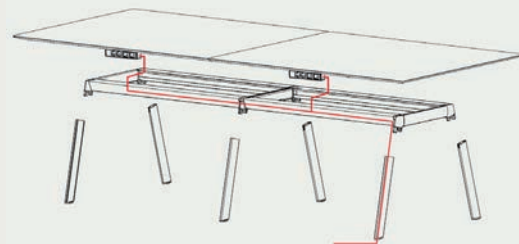

PS0716
PS0717

PS0718

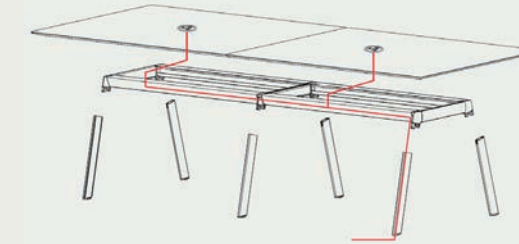

PS0715

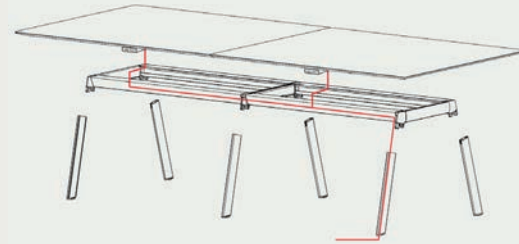

Wire management / Conectividad

America

In surface En superficie



Integrated connection system

Composed of an interior cover with the same finish as the table top, and exterior frame in matt black finish. Its opening is made on both sides. Two system sizes are available, configurable from 2 + 2 or 3 + 3 where 1 or 2 power ports are included depending on the choice + 1 USB charging port and the rest are configurable, and may include Minijack, VGA, HDMI, USB data ports or RJ45.

Sistema de conexiones integrado

Compuesto por una tapa interior con el mismo acabado que el sobre y un marco exterior de acabado negro mate. Su apertura se realiza en ambos lados. Se ofrecen dos tamaños de sistemas, configurables de 2+2 o 3+3 donde se incluyen 1 o 2 powers dependiendo de la elección + 1 USB de carga y los restantes son configurables, pudiendo incluir Minijack, VGA, HDMI, USB de datos o RJ45.



PS0711

PS0721

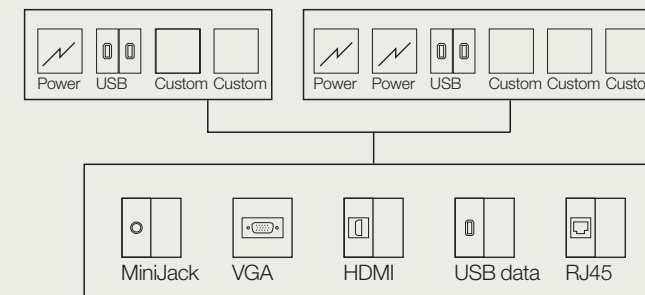

In surface En superficie



Integrated connection system

Composed of an interior cover with an exterior frame, both in anodized finish. Its opening is made by a soft touch. Two system sizes are available, configurable from 2 + 2 or 3 + 3 where 1 or 2 power ports are included depending on the choice + 1 USB charging port and the rest are configurable, and may include Minijack, VGA, HDMI, USB data ports or RJ45.

Sistema de conexiones en superficie

Compuesto por una tapa interior y un marco exterior, ambos en acabado anodizado. Su apertura se realiza con una suave pulsación. Se ofrecen 2 tamaños de sistemas, configurables 2+2 o 3+3 donde se incluyen 2 o 3 powers dependiendo de la elección, y los restantes son configurables, pudiendo incluir Minijack, VGA, HDMI, USB de datos o RJ 45.



PS0752

PS0753

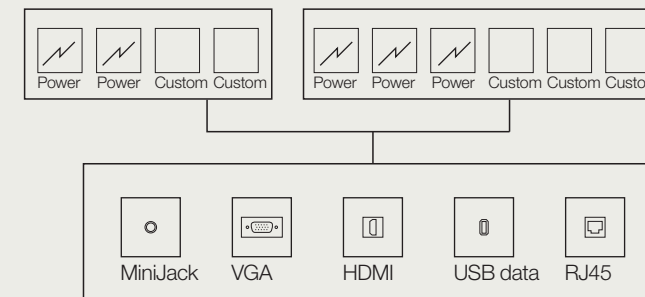

Wire management / Conectividad

America

Under top
Bajo sobre



Under table top connection system

Composed of a profile, in two finishes, black or white. Several sizes and configurations are available depending on the needs, 2 + 2 or 3 + 3, where 1 or 2 powers + 1 USB double charging are included, or if USB charging is not required 2 or 3 powers, and the rest are configurable being able to include minijack and USB, VGA, HDMI and USB, 2 USB data or 2 RJ45. There is also a 1 + 1 version for small tables consisting of 1 power and the remaining configurable with minijack and USB, VGA, HDMI and USB, 2 USB data, 2 RJ45 or 2 USB charging.

Sistema de conexiones bajo el sobre

Compuesto por un perfil, en dos acabados, negro o blanco. Se ofrecen varios tamaños y configuraciones dependiendo de las necesidades, 2+2 o 3+3, donde se incluyen 1 o 2 powers + 1 USB de carga doble, o si no se requiere USB de carga 2 o 3 powers, y los restantes son configurables pudiendo incluir minijack y USB, VGA, HDMI and USB, 2 USB de datos o 2 RJ45. También hay una versión de 1+1 para mesas pequeñas compuesto por 1 power y el restante configurable con minijack y USB, VGA, HDMI and USB, 2 USB de datos, 2 RJ45 o 2 USB de carga.



PS0755

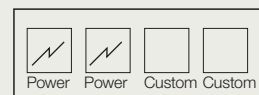

PS0756

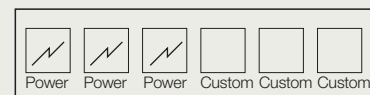

PS0750

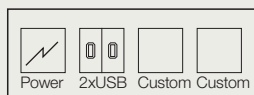

PS0751

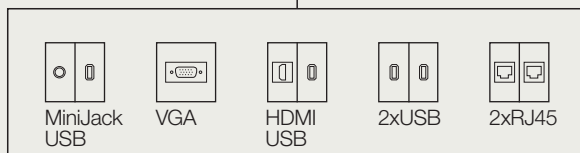
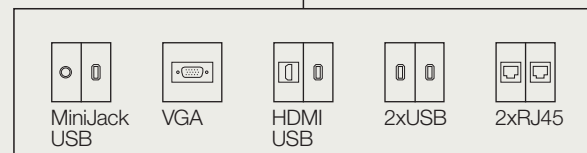
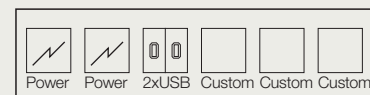

Wire management / Conectividad

America

In surface
En superficie



Integrated connection system

Composed of 2 powers and 2 USB charging. The system turns on itself and remains hidden when it is not in use. It is available in two finishes, black and white.

Sistema de conexiones integrado

Compuesto por 2 powers y 2 USB de carga. El sistema gira sobre si mismo y permanecer oculto cuando no este en uso. Está disponible en dos acabados, negro y blanco.

PS0713



In surface
En superficie



USB charging system

Composed of 2 USB charging. It is available in two finishes, black and white.

Sistema de carga USB

Compuesto por 2 USB de carga . Está disponible en dos acabados, negro y blanco.

PS0718



In surface
En superficie



Qi charging system

Composed of a large surface for charging by induction, 1 power + 1USB charging (PS 0716) or 2USB charging (PS 0717). It is available in two finishes, black and white.

Sistema de carga Qi

Compuesto por una amplia superficie para cargar por inducción , 1 power+ 1USB de carga (PS 0716) o 2 USB de carga (PS 0717). Está disponible en dos acabados, negro y blanco.

PS0716 / PS0717



Under top
Bajo sobre



Under table top USB charging system

Composed of 2 USB charging, black or white. It is composed of two USB charging ports.

Sistema de USB de carga bajo el sobre

Compuesto por 2 USB de carga . Está disponible en dos acabados, negro y blanco.

PS0715



Wire management / Conectividad

Europe / RoW

**Distribution
Distribución**

- 1. Power boxes distribution:** By standard, the power/data box would be offset relative to the base. For tables with more than one power box, these will be separated 1/3 between them and placed horizontally and longitudinally.
- 2. Wire management:** The cable passes through an aluminum wire manager, keeping it hidden from the users.
- 3. Wiring exit:** the cable exits directly from the power system or through an aluminum frame so that it is concealed at the bottom of the base. The cable then crosses the aluminum profiles of the legs and is completely hidden until it reaches the floor.

- 1. Distribución de sistemas:** De serie, el sistema de conexiones se dispondrá en el centro de la mesa. Para las mesas con más de un sistema, estos se colocarán con una separación de 1/3 de la longitud total de la mesa y en sentido longitudinal.
- 2. Gestión del cableado:** El cable sale del sistema de electrificación, pasa a través del perfil de aluminio lateral y baja por la pata.
- 3. Salida del cableado:** La salida del cable se realiza directamente desde el propio sistema de conexiones a través del perfil de aluminio lateral, que oculta el cableado y baja por el interior de la pata hasta llegar al suelo.

PS0710
PS0720

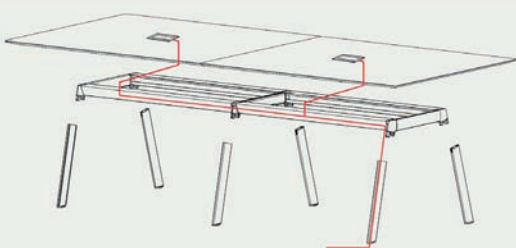

PS0787
PS0788

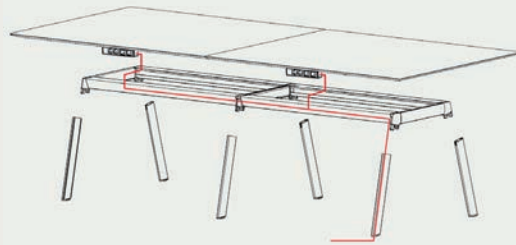

PS0718

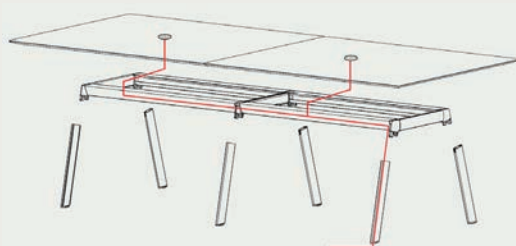

PS0784
PS0785

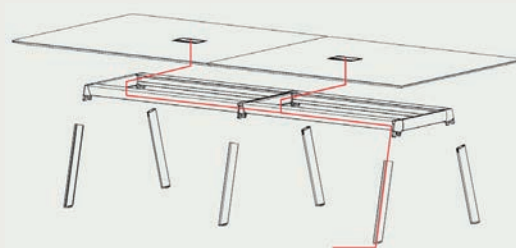

PS0715

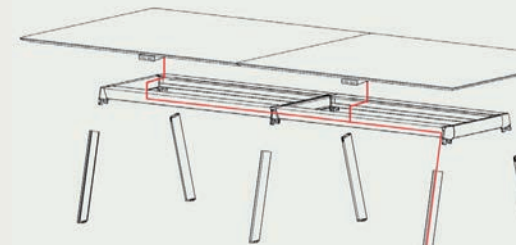

PS0714

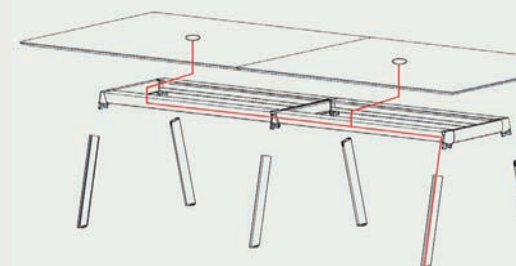

Wire management / Conectividad

Europe / RoW

**In surface
En superficie**



Integrated connection system

Composed of an interior cover with the same finish as the table top, and exterior frame in matt black finish. Its opening is made on both sides. Two system sizes are available, configurable from 2 + 2 or 3 + 3 where 1 or 2 power ports are included depending on the choice + 1 USB charging port and the rest are configurable, and may include Minijack, VGA, HDMI, USB data ports or RJ45.

Sistema de conexiones integrado

Compuesto por una tapa interior con el mismo acabado que el sobre y un marco exterior de acabado negro mate. Su apertura se realiza en ambos lados. Se ofrecen dos tamaños de sistemas, configurables de 2+2 o 3+3 donde se incluyen 1 o 2 powers dependiendo de la elección + 1 USB de carga y los restantes son configurables, pudiendo incluir Minijack, VGA, HDMI, USB de datos o RJ45.



PS0710

PS0720

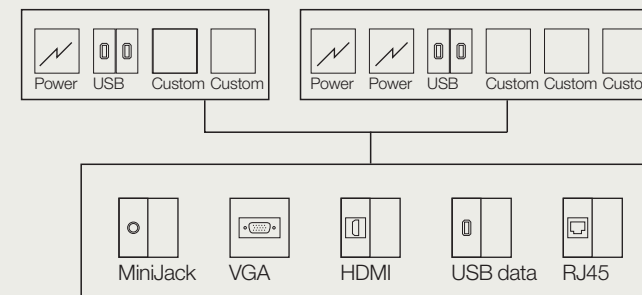

**In surface
En superficie**



Integrated connection system

Composed of an interior cover with an exterior frame, both in anodized finish. Its opening is made by a soft touch. Two system sizes are available, configurable from 2 + 2 or 3 + 3 where 1 or 2 power ports are included depending on the choice + 1 USB charging port and the rest are configurable, and may include Minijack, VGA, HDMI, USB data ports or RJ45.

Sistema de conexiones en superficie

Compuesto por una tapa interior y un marco exterior, ambos en acabado anodizado. Su apertura se realiza con una suave pulsación. Se ofrecen 2 tamaños de sistemas, configurables 2+2 o 3+3 donde se incluyen 2 o 3 powers dependiendo de la elección, y los restantes son configurables, pudiendo incluir Minijack, VGA, HDMI, USB de datos o RJ 45.



PS0784

PS0785

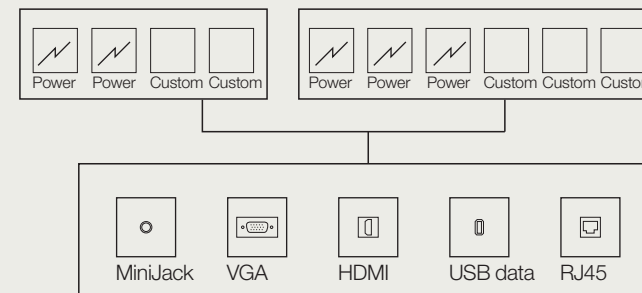

Wire management / Conectividad

Europe / RoW

Under top
Bajo sobre 

Under table top connection system

Composed of a profile, in two finishes, black or white. Several sizes and configurations are available depending on the needs, 2 + 2 or 3 + 3, where 1 or 2 powers + 1 USB double charging are included, or if USB charging is not required 2 or 3 powers, and the rest are configurable being able to include minijack and USB, VGA, HDMI and USB, 2 USB data or 2 RJ45. There is also a 1 + 1 version for small tables consisting of 1 power and the remaining configurable with minijack and USB, VGA, HDMI and USB, 2 USB data, 2 RJ45 or 2 USB charging.

Sistema de conexiones bajo el sobre

Compuesto por un perfil, en dos acabados, negro o blanco. Se ofrecen varios tamaños y configuraciones dependiendo de las necesidades, 2+2 o 3+3, donde se incluyen 1 o 2 powers + 1 USB de carga doble, o si no se requiere USB de carga 2 o 3 powers, y los restantes son configurables pudiendo incluir minijack y USB, VGA, HDMI and USB, 2 USB de datos o 2 RJ45. También hay una versión de 1+1 para mesas pequeñas compuesto por 1 power y el restante configurable con minijack y USB, VGA, HDMI and USB, 2 USB de datos, 2 RJ45 o 2 USB de carga.



PS0787

PS0788

PS0789

PS0790

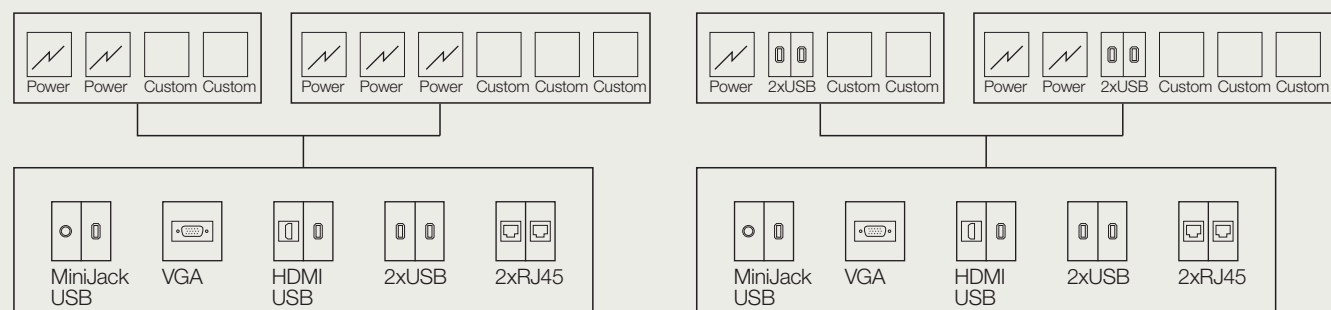

Wire management / Conectividad

Europe / RoW

Under top
Bajo sobre 

Under table top USB charging system

Composed of 2 USB charging, black or white. It is composed of two USB charging ports.

Sistema de USB de carga bajo el sobre

Compuesto por 2 USB de carga. Está disponible en dos acabados, negro y blanco.

PS0715



In surface
En superficie 

Qi charging system

Composed of a large surface for charging by induction., It is available in two finishes, black and white.

Sistema de carga Qi

Compuesto por una amplia superficie para cargar por inducción. Está disponible en dos acabados, negro y blanco.

PS0714



In surface
En superficie 

Qi charging system

Composed of 2 USB charging. It is available in two finishes, black and white.

Sistema de carga Qi

Compuesto por una amplia superficie para cargar por inducción. Está disponible en dos acabados, negro y blanco.

PS0718



The versatility of the Reverse system is its ability to be combined with table tops of different sizes, finishes, formats and materials. This aspect and its numerous electric and multimedia solutions meets all requirements for today's workspace.

La versatilidad de este programa de mesas se basa en sus posibilidades de combinación. Los sobres, de diferentes tamaños, acabados, formatos y materiales. Se completa con soluciones integrales de conectividad eléctrica y multimedia que cumplen con todos los requisitos para los espacios de trabajo de hoy.

Reverse Conference Table

by Piergiorgio Cazzaniga



Conference room

Sala de reunión

▼ ME 5022 / SO1305

Table with elliptical oak top
and three central bases.

Mesa con sobre elíptico de
roble y tres bases centrales.



Conference room

Sala de reunión

▼ ME5034 / SO1305

Table with elliptical lacquered top and three central bases.

Mesa con sobre elíptico lacado y tres bases centrales.



Conference room
Sala de reunión

▼ ME5017 / SH1304

Table with elliptical lacquered top and two central bases.
Mesa con sobre elíptico lacado y dos bases centrales.



Conference room
Sala de reunión

▼ ME5018 / SH1304

Table with elliptical lacquered top and two bases.
Mesa con sobre elíptico lacado y dos bases.



Conference room

Sala de reunión

▼ ME5026 / SH1314

Table with elliptical oak top and three central bases.

Mesa con sobre elíptico de roble y tres bases centrales.



Conference room

Sala de reunión

▼ ME5244 / SO1634

Table with round lacquered top and central base.

Mesa con sobre redondo lacado y bases central.



**Conference room
Sala de reunión**

▼ ME5697 / SH1304

Table with cement round top
and cement central base.
Mesa con sobre redondo de
cemento y base central de
cemento.



**Conference room
Sala de reunión**

▼ ME5080 / SO4205

Table with round lacquered
top and central base.
Mesa con sobre redondo
lacado y base central.



Conference room

Sala de reunión

▼ ME5167 / SO1645

Table with elliptical laminated top
and three central bases.

Mesa con sobre elíptico
laminado y tres bases centrales.



Conference room
Sala de reunión

▼ ME5419 / SO1646

Table with round top with
cement finish and central
bases.

Mesa con sobre redondo con
acabado de cemento y base
central.



Conference room
Sala de reunión

▼ ME9822 / BQ2781

High table. Table with elliptical
oak top and two central
bases.

Mesa alta. Mesa con sobre
elíptico de roble y dos bases
centrales.



▼ ME9959

Table with central base and top in ash and swivel centre top in marble.
Mesa con base central y sobre de madera de fresno con plato giratorio central de mármol.

Residential
Hogar

► ME9959 / SO0496
Table with central base and top in ash and swivel centre top in marble.
Mesa con base central y sobre de madera de fresno con plato giratorio central de mármol.



Tops/Sobres

Table program available with different types of board table tops of different shapes and sizes, available in oak finish, lacquered, laminated, TP laminate, Technical stone 8, glass, linoleum, ultra-matte and cement finishes. Table program suitable for different types of polyethylene central bases available in various colors and cement finish.

Programa de mesas disponible con diferentes tipos de sobres de mesa de tablero de diferentes formas y medidas, disponibles en acabado roble, lacado, technical stone 8, cristal, linóleo, ultra-matte y cemento.

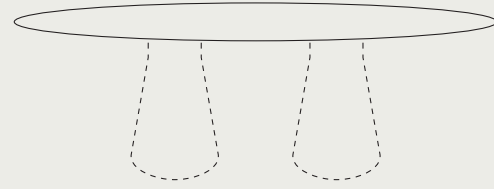

Oak Roble



306 307 378 322 336 364 372 369 381 304 318 320

Premium finishes and wood lacquers Acabados premium y lacados



610 641 645L Sand Arena NCS 4005-Y20R Basalt grey Gris basalto 605L NCS S 6502-B Dark grey Gris oscuro 380 661 Red Rojo 642L Cayenne red Rojo cayena 606L RAL 1005 Yellow mustard Amarillo mostaza

Laminate / Laminado TP Laminado / Laminado TP



L205 Oak Roble L204 Maple Arce L203 Cherry Cerezo L202 Walnut Nogal L206 Dark walnut Nogal oscuro L200 White Blanco L201 Black Negro L300 Sand Arena L302 Basalt grey Gris basalto L301 Dark grey Gris oscuro

Glass Cristal



White Blanco Sand Arena Basalt grey Gris basalto Cayenne red Rojo cayena Dark grey Gris oscuro Matte black Negro mate

Technical stone 8

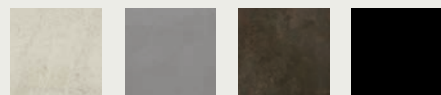

DKAR Sand Arena DKRC Rock grey Gris roca DKMR Earth brown Marrón tierra DKNG Black Negro

Cement Cemento

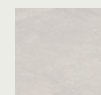

Cement

Linoleum Linóleo

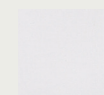

L315 Ivory Marfil

Ultra-matte Ultramate

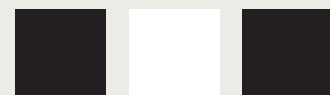

L316 Black Negro L310 White Blanco L311 Black Negro

Tops/Sobres

Top 30 Razor

30mm./1.18in. thick table top and bevelled edge. Sobre de mesa de 30mm./1.18in. de espesor y con canto biselado.

Oak / Roble Laminated / Laminado Lacquered / Lacado Linoleum / Linóleo Ultra-matte / Ultramate Cement / Cemento Technical stone 8 Ash / Fresno



Top 30 Razor TP

30mm./1.18in. thick table top and matching thermopolymer bevelled edge. Sobre de mesa de 30mm./1.18in. de espesor y con canto de termopolímero a juego.

Laminated TP / Laminado TP Ultra-matte TP / Ultramate TP



Top Glass 35

36mm./1.4in. thick table top, with 6mm./0.2in. tempered glass + 30mm./1.2in. substrate. Sobre de mesa de 36mm./1.4in. de espesor, con cubierta de cristal templado de 6mm./0.2in. + sustrato de 30mm./1.2in.



Bases

Table program suitable for different types of polyethylene central bases available in various colors and cement finish.

Programa de mesas apto para diferentes tipos de bases centrales de polietileno disponible en varios colores y acabado cemento.

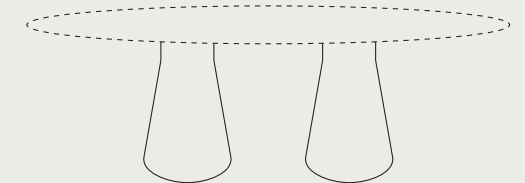

Polyethylene Polietileno



6000 White Blanco 6002 Sand Arena 6012 Basalt grey Gris basalto 6006 Black Negro 6013 Dark Grey Gris oscuro

Cement Cemento

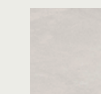

Cement

Meeting tables / Mesas de reunión

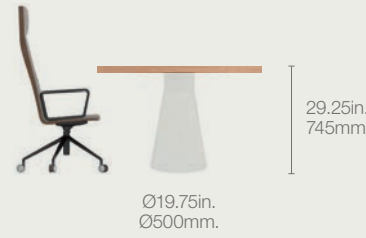

Ø19.75in.
Ø500mm.



Ø1.400mm. Ø55.25in. 6 persons
Ø1.500mm. Ø59.00in. 6 persons



1.400 x 1.400mm. 55.25 x 55.25in. 6 persons



Ø23.75in.
Ø600mm.



Ø1.600mm. Ø63.00in. 6 persons
Ø1.700mm. Ø67.00in. 6 persons
Ø1.800mm. Ø71.00in. 6-8 persons



1.500 x 1.500mm. 59.00 x 59.00in. 6 persons
1.600 x 1.600mm. 63.00 x 63.00in. 6 persons



Ø31.50in.
Ø800mm.



Ø1.900mm. Ø74.75in. 8 persons
Ø2.000mm. Ø78.75in. 8 persons
Ø2.100mm. Ø82.75in. 8 persons



1.700 x 1.700mm. 67.00 x 67.00in. 8 persons
1.800 x 1.800mm. 71.00 x 71.00in. 8 persons
1.900 x 1.900mm. 74.75 x 74.75in. 8 persons

Meeting tables / Mesas de reunión



Ø15.00in. Ø15.00in.
Ø380mm. Ø380mm.



2.200 X 1.200mm. 86.50 x 47.25in. 8-10 persons
2.400 X 1.200mm. 94.50 x 47.25in. 8-10 persons



Ø19.75in. Ø19.75in.
Ø500mm. Ø500mm.

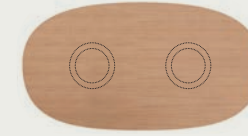

2.600 X 1.500mm. 102.50 x 59.00in. 8-10 persons
2.800 X 1.500mm. 110.25 x 59.00in. 8-10 persons
3.000 X 1.500mm. 118.00 x 59.00in. 12-14 persons



Ø19.75in. Ø19.75in. Ø19.75in.
Ø500mm. Ø500mm. Ø500mm.

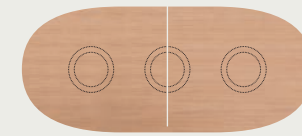

3.500 X 1.500mm. 137.75 x 59.00in. 12-14 persons
4.000 X 1.500mm. 157.50 x 59.00in. 12-14 persons
4.500 X 1.500mm. 177.25 x 59.00in. 12-14 persons
5.000 X 1.500mm. 196.75 x 59.00in. 12-14 persons



Ø19.75in. Ø19.75in. Ø19.75in.
Ø500mm. Ø500mm. Ø500mm.

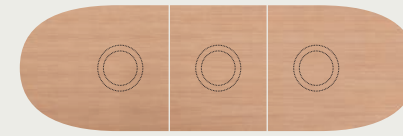

5.500 X 1.500mm. 216.50 x 59.00in. 16-18 persons
6.000 X 1.500mm. 236.25 x 59.00in. 16-18 persons



Ø19.75in. Ø19.75in. Ø19.75in. Ø19.75in.
Ø500mm. Ø500mm. Ø500mm. Ø500mm.

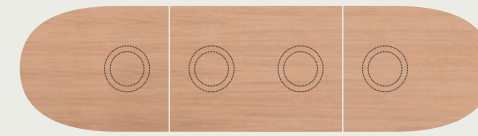

6.500 X 1.500mm. 256.00 x 59.00in. 18-20 persons
7.000 X 1.500mm. 275.50 x 59.00in. 20-22 persons
7.500 X 1.500mm. 295.25 x 59.00in. 20-22 persons

High Tables / Mesas altas

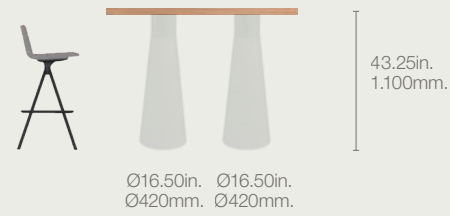

Ø16.50in. Ø16.50in.
Ø420mm. Ø420mm.



2.200 X 800mm. 86.75 x 31.50in. 8-10 persons
2.400 X 800mm. 94.50 x 31.50in. 8-10 persons



Ø16.50in. Ø16.50in.
Ø420mm. Ø420mm.



2.200 X 900mm. 86.75 x 35.50in. 8-10 persons
2.400 X 900mm. 94.50 x 35.50in. 8-10 persons



Ø20.50in. Ø20.50in.
Ø520mm. Ø520mm.



2.200 X 1.100mm. 86.75 x 43.25in. 8-10 persons
2.400 X 1.100mm. 94.50 x 43.25in. 8-10 persons
2.600 X 1.100mm. 102.50 x 43.25in. 8-10 persons



Ø20.50in. Ø20.50in.
Ø520mm. Ø520mm.



2.200 X 1.200mm. 86.75 x 47.25in. 8-10 persons
2.400 X 1.200mm. 94.50 x 47.25in. 8-10 persons
2.600 X 1.200mm. 102.50 x 47.25in. 8-10 persons



Ø16.50in. Ø16.50in. Ø16.50in.
Ø420mm. Ø420mm. Ø420mm.



2.600 X 800mm. 102.50 x 31.50in. 8-10 persons
2.800 X 800mm. 110.25 x 31.50in. 8-10 persons
3.000 X 800mm. 118.00 x 31.50in. 10-12 persons

High Tables / Mesas altas

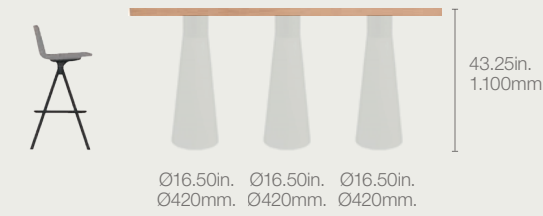

Ø16.50in. Ø16.50in. Ø16.50in.
Ø420mm. Ø420mm. Ø420mm.



2.600 X 900mm. 102.50 x 35.50in. 8-10 persons
2.800 X 900mm. 110.25 x 35.50in. 8-10 persons
3.000 X 900mm. 118.00 x 35.50in. 10-12 persons



Ø20.50in. Ø20.50in. Ø20.50in.
Ø520mm. Ø520mm. Ø520mm.



2.800 X 1.100mm. 110.25 x 43.25in. 8-10 persons
3.000 X 1.100mm. 118.00 x 43.25in. 10-12 persons



Ø20.50in. Ø20.50in. Ø20.50in.
Ø520mm. Ø520mm. Ø520mm.



2.800 X 1.200mm. 110.25 x 47.25in. 8-10 persons
3.000 X 1.200mm. 118.00 x 47.25in. 10-12 persons

Wall Tables Mesas a pared

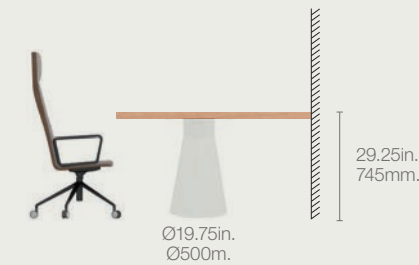

Ø19.75in.
Ø500mm.

1.500 x 1.500mm. 59.00 x 59.00in. 6 persons
2.000 x 1.500mm. 78.75 x 59.00in. 6-8 persons
2.500 x 1.500mm. 98.50 x 59.00in. 6-8 persons
3.000 x 1.500mm. 118.00 x 59.00in. 8-10 persons

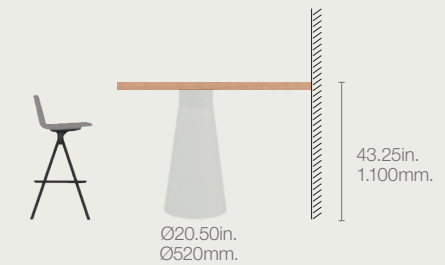

Ø20.50in.
Ø520mm.

1.500 x 1.500mm. 59.00 x 59.00in. 6 persons
2.000 x 1.500mm. 78.75 x 59.00in. 6-8 persons
2.500 x 1.500mm. 98.50 x 59.00in. 6-8 persons
3.000 x 1.500mm. 118.00 x 59.00in. 8-10 persons

Tops / Sobres

Table program with top in ash, available swivel centre top in marble, lacquered wood or technical stone 8. Round tops only version, in three sizes. Connection box available. *If the top is electrified, the swivel centre top will be fixed.

Programa de mesas disponible con sobres de madera de fresno con opción de plato giratorio central en diferentes acabados, mármol, madera lacada o technical stone 8. Sobre sólo redondo, en tres medidas. Disponible caja de conexiones. *En caso de mesa electrificada, no podrá tener plato giratorio.

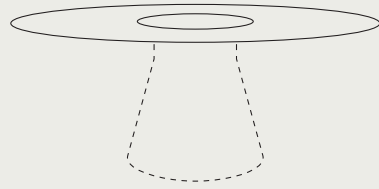

Ash Fresno

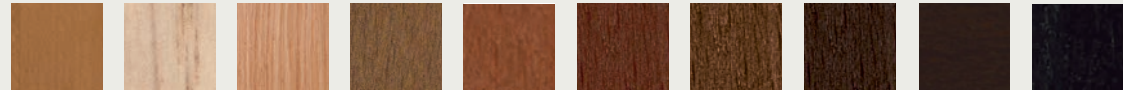

305 306 307 378 322 336 364 372 369 381

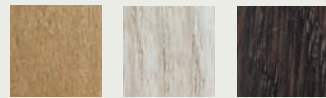

304 308 318

Premium finishes and wood lacquers Acabados premium y lacados



610 641 645L Sand Arena NCS 4005-Y20R Basalt grey Gris basalto 605L NCS S 6502-B Dark grey Gris oscuro 380 661 Red Rojo 642L Cayenne red Rojo cayena 606L RAL 1005 Yellow mustard Amarillo mostaza

Technical stone 8

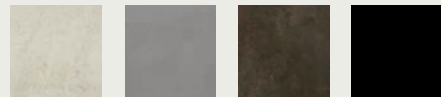

DKAR Sand Arena DKRC Rock grey Gris roca DKMR Earth brown Marrón tierra DKNG Black Negro

Marble top Sobres marmol

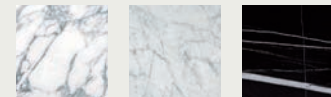

Calacatta Carrara Bamboo Bambú

Bases

Table program with central base in ash.

Programa de mesas disponible con bases centrales de madera de fresno.

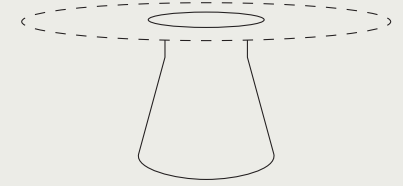

Ash Fresno



305 306 307 378 322 336 364 372 369 381

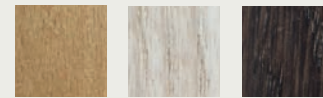

304 308 318

Tables / Mesas



Wire management / Conectividad

America

**Distribution
Distribución**

1. **System distribution:** As standard, the connection system will be located in the center of the table. For tables with more than one system, these will be placed with a separation of 1/3 of the total length of the table and in the longitudinal direction.
2. **Wire management:** The cable leaves the power system, passes through an aluminum profile and travels down one of the bases, if there is a single base, the cable will exit directly from it.
3. **Wire outlet:** The cable exits directly from the connection system through an aluminum profile that hides the wiring and down the inside one of the thermopolymer bases. If there is a single base, the cable will run directly through it, without using any aluminum profile, to the ground.

PS0711
PS0721

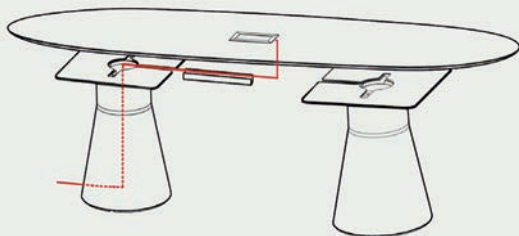

PS0752
PS0753

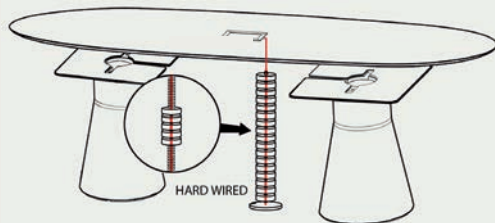
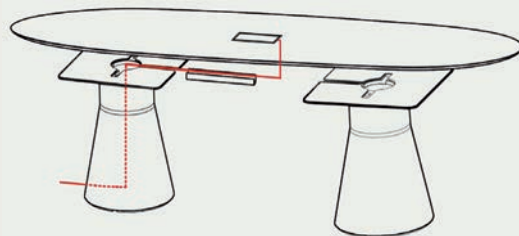

Hard wired, applicable to PS0752 and PS0753. They are offered as an extra option.
Hard wired, aplicable a PS0752 y PS0753. Se ofrecen como una opción extra.

PS0755
PS0756

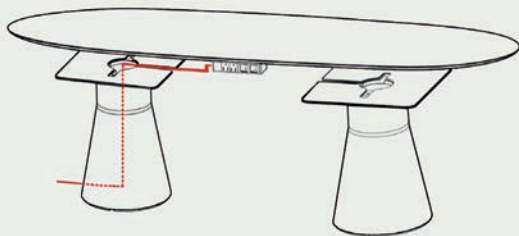

PS0750
PS0751

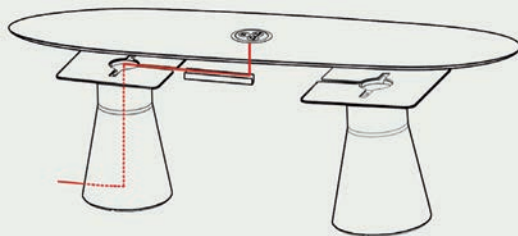

PS0713

Wire management / Conectividad

America

**Distribution
Distribución**

1. **Distribución de sistemas:** De serie, el sistema de conexiones se dispondrá en el centro de la mesa. Para las mesas con más de un sistema, estos se colocarán con una separación de 1/3 de la longitud total de la mesa y en sentido longitudinal.
2. **Gestión del cableado:** El cable sale del sistema de electrificación, pasa a través de un perfil de aluminio y baja por una de las bases, si hay una única base, el cable saldrá directamente a través de esta.
3. **Salida del cableado:** La salida del cable se realiza directamente desde el propio sistema de conexiones a través de un perfil de aluminio que oculta el cableado y baja por el interior de una de las bases de termopolímero. Si hay una única base, el cable saldrá directamente a través de esta, sin necesidad de utilizar ningún perfil de aluminio, hasta el suelo.

PS0715

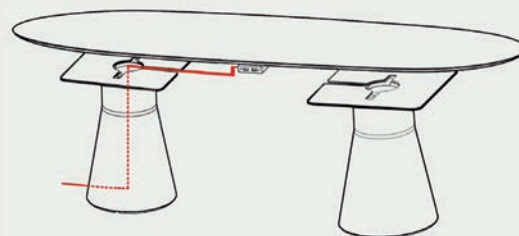

PS0716
PS0717

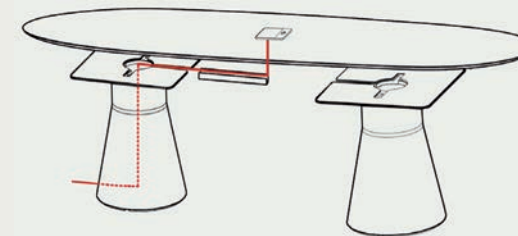

PS0718

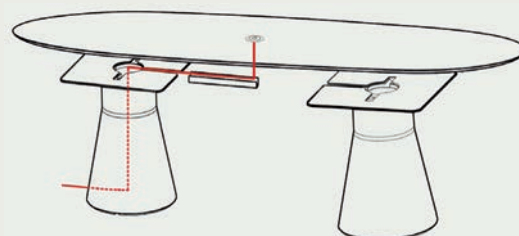

PS0693
PS0694

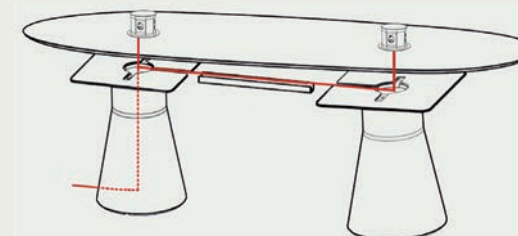

PS0799
PS0800

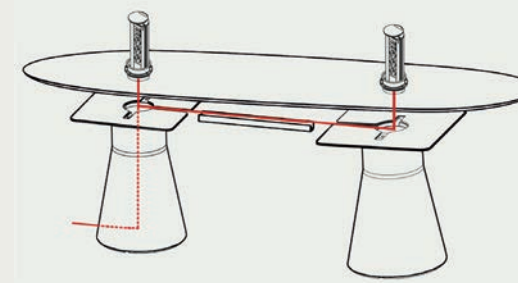

Wire management / Conectividad

America

**Distribution
Distribución**

1. **System distribution:** As standard, the connection system will be located in the center of the table. For tables with more than one system, these will be placed with a separation of 1/3 of the total length of the table and in the longitudinal direction.
2. **Wire management:** The cable leaves the power system, passes through an aluminum profile and travels down one of the bases, if there is a single base, the cable will exit directly from it.
3. **Wire outlet:** The cable exits directly from the connection system through an aluminum profile that hides the wiring and down the inside one of the thermopolymer bases. If there is a single base, the cable will run directly through it, without using any aluminum profile, to the ground.

PS0711
PS0721

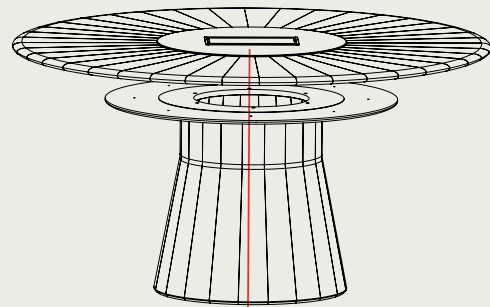

PS0752
PS0753

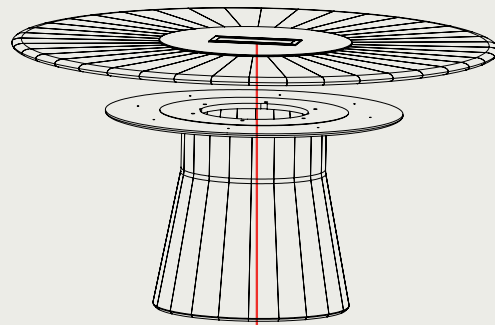

PS0755
PS0756

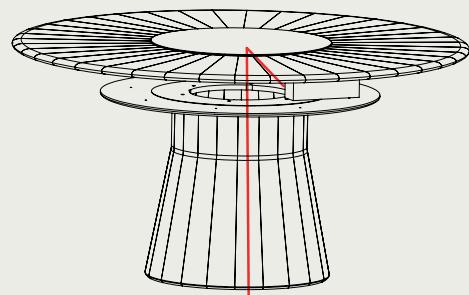

PS0750
PS0751

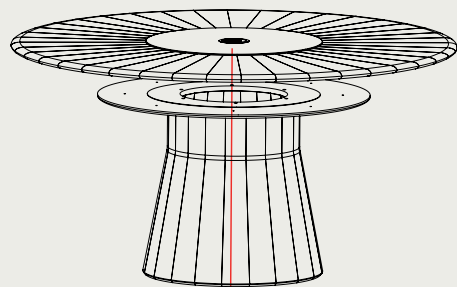

PS0713

PS0718

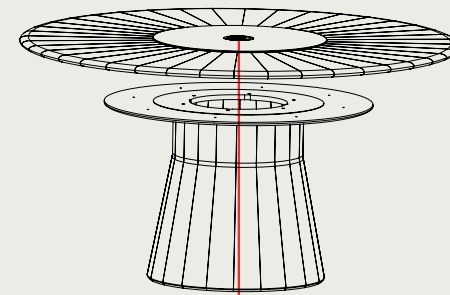

PS0693
PS0694

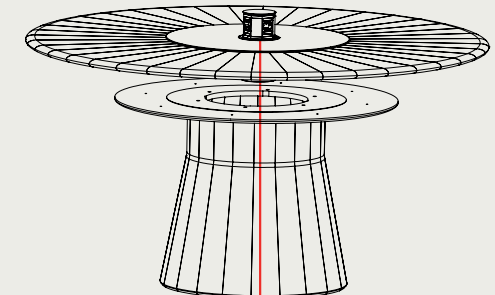

PS0799
PS0800

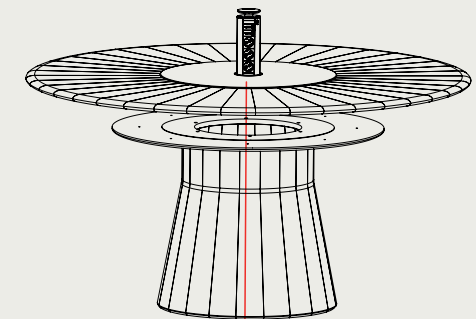

Wire management / Conectividad

America

**Distribution
Distribución**

1. **Distribución de sistemas:** De serie, el sistema de conexiones se dispondrá en el centro de la mesa. Para las mesas con más de un sistema, estos se colocarán con una separación de 1/3 de la longitud total de la mesa y en sentido longitudinal.
2. **Gestión del cableado:** El cable sale del sistema de electrificación, pasa a través de un perfil de aluminio y baja por una de las bases, si hay una única base, el cable saldrá directamente a través de esta.
3. **Salida del cableado:** La salida del cable se realiza directamente desde el propio sistema de conexiones a través de un perfil de aluminio que oculta el cableado y baja por el interior de unas de las bases de termopolímero. Si hay una única base, el cable saldrá directamente a través de esta, sin necesidad de utilizar ningún perfil de aluminio, hasta el suelo.

PS0715

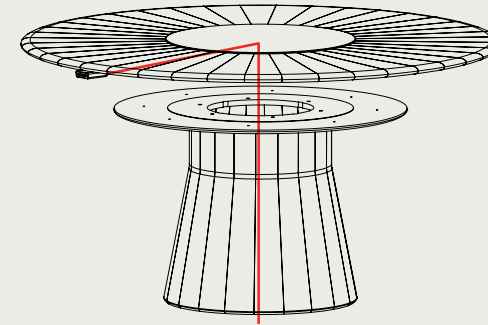

PS0716
PS0717

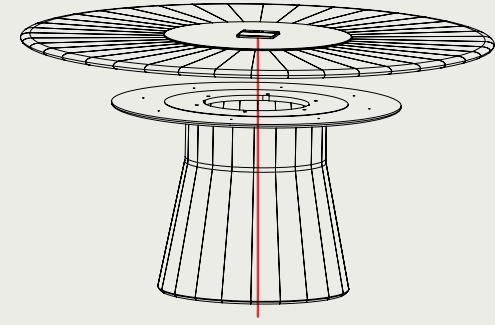

Wire management / Conectividad

America

In surface
En superficie 

Integrated connection system

Composed of an interior cover with the same finish as the table top, and exterior frame in matt black finish. Its opening is made on both sides. Two system sizes are available, configurable from 2 + 2 or 3 + 3 where 1 or 2 power ports are included depending on the choice + 1 USB charging port and the rest are configurable, and may include MiniJack, VGA, HDMI, USB data ports or RJ45.

Sistema de conexiones integrado

Compuesto por una tapa interior con el mismo acabado que el sobre y un marco exterior de acabado negro mate. Su apertura se realiza en ambos lados. Se ofrecen dos tamaños de sistemas, configurables de 2+2 o 3+3 donde se incluyen 1 o 2 powers dependiendo de la elección + 1 USB de carga y los restantes son configurables, pudiendo incluir MiniJack, VGA, HDMI, USB de datos o RJ45.

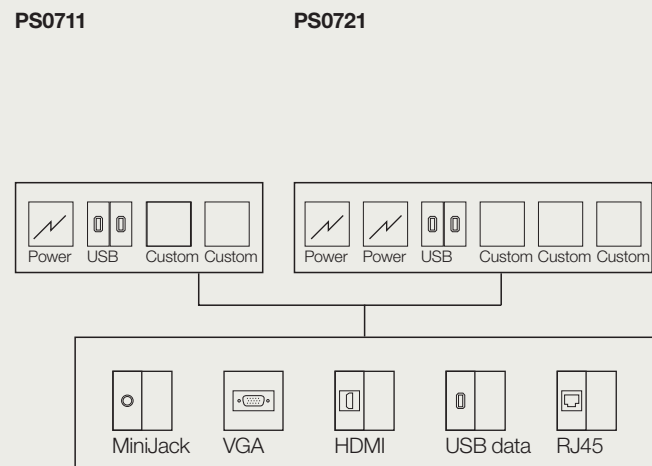

In surface
En superficie 

Surface connection system

Composed of an interior cover with an exterior frame, both in anodized finish. Its opening is made by a soft touch. Two system sizes are available, configurable from 2 + 2 or 3 + 3 where 2 or 3 power ports are included depending on the choice and the rest are configurable, and may include MiniJack, VGA, HDMI, USB data ports or RJ45.

Sistema de conexiones integrado

Compuesto por una tapa interior y un marco exterior, ambos en acabado anodizado. Su apertura se realiza con una suave pulsación. Se ofrecen 2 tamaños de sistemas, configurables 2+2 o 3+3 donde se incluyen 2 o 3 powers dependiendo de la elección, y los restantes son configurables, pudiendo incluir MiniJack, VGA, HDMI, USB de datos o RJ 45.

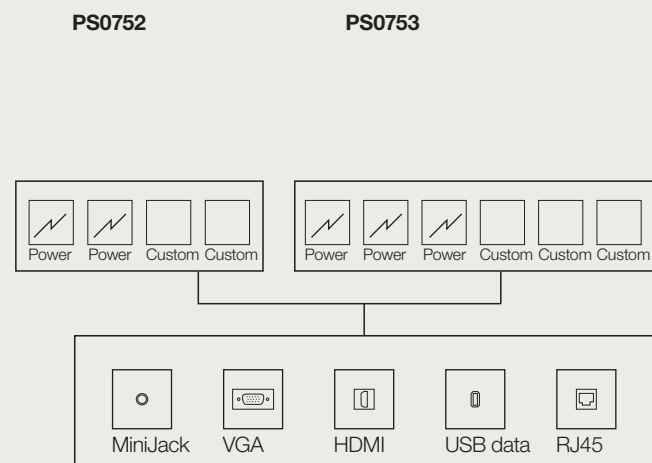

Wire management / Conectividad

America

Under top
Bajo sobre 

Under table top connection system

Composed of a profile, in two finishes, black or white. Several sizes and configurations are available depending on the needs, 2 + 2 or 3 + 3, where 1 or 2 powers + 1 USB double charging are included, or if USB charging is not required 2 or 3 powers, and the rest are configurable being able to include miniJack and USB, VGA, HDMI and USB, 2 USB data or 2 RJ45. There is also a 1 + 1 version for small tables consisting of 1 power and the remaining configurable with miniJack and USB, VGA, HDMI and USB, 2 USB data, 2 RJ45 or 2 USB charging.

Sistema de conexiones bajo el sobre

Compuesto por un perfil, en dos acabados, negro o blanco. Se ofrecen varios tamaños y configuraciones dependiendo de las necesidades, 2+2 o 3+3, donde se incluyen 1 o 2 powers + 1 USB de carga doble, o si no se requiere USB de carga 2 o 3 powers, y los restantes son configurables pudiendo incluir miniJack y USB, VGA, HDMI and USB, 2 USB de datos o 2 RJ45. También hay una versión de 1+1 para mesas pequeñas compuesto por 1 power y el restante configurable con miniJack y USB, VGA, HDMI and USB, 2 USB de datos, 2 RJ45 o 2 USB de carga.

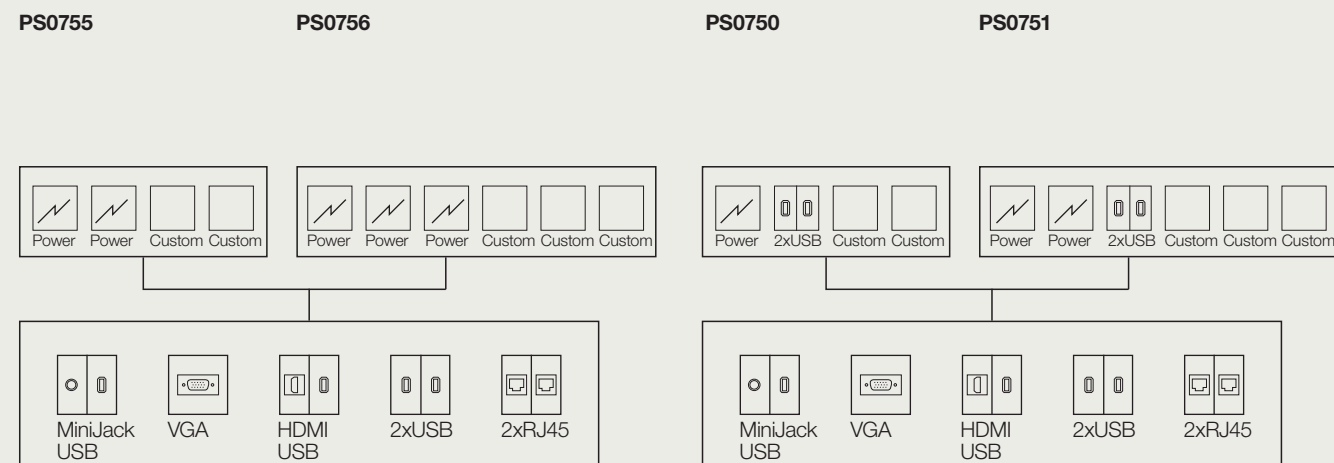

Wire management / Conectividad

America

In surface
En superficie 

Integrated connection system

Composed of 2 powers and 2 USB charging. The system turns on itself and remains hidden when it is not in use. It is available in two finishes, black and white.

Sistema de conexiones integrado

Compuesto por 2 powers y 2 USB de carga. El sistema gira sobre si mismo y permanecer oculto cuando no este en uso. Está disponible en dos acabados, negro y blanco.

PS0713



In surface
En superficie 

Qi charging system

Composed of a large surface for charging by induction, 1 power + 1USB charging (PS 0716) or 2USB charging (PS 0717). It is available in two finishes, black and white.

Sistema de carga Qi

Compuesto por una amplia superficie para cargar por inducción, 1 power+ 1USB de carga (PS 0716) o 2 USB de carga (PS 0717). Está disponible en dos acabados, negro y blanco.

PS0716 / PS0717



In surface
En superficie 

USB charging system

Composed of 2 USB charging. It is available in two finishes, black and white.

Sistema de carga USB

Compuesto por 2 USB de carga. Está disponible en dos acabados, negro y blanco.

PS0718



Under top
Bajo sobre 

Under table top USB charging system

Composed of 2 USB charging, black or white. It is composed of two USB charging ports.

Sistema de USB de carga bajo el sobre

Compuesto por 2 USB de carga. Está disponible en dos acabados, negro y blanco.

PS0715



Wire management / Conectividad

America

In surface
En superficie 

Lifting connection system

Consisting of an aluminum junction box, integrated into the surface of the table top with hinged lid and the lid opens with gentle pressure. In anodized finish, for other finishes consult the Sales Department. Extraction connection systems.

Sistema de conexiones integrado

Compuesto por una caja de conexiones de aluminio, integrada dentro de la superficie del sobre con tapa abatible. su apertura se realiza con una suave pulsación. En acabado anodizado, para otros acabados consultar al Departamento Comercial. Sistemas de conexión de extracción.



In surface
En superficie 

Lifting connection system

Consisting of an aluminum junction box, integrated into the surface of the table top with hinged lid. The lid is opened by pulling the lid in a perpendicular direction and opposite the top where it is located. In white black and gray finish.

Sistema de conexiones elevable

Compuesto por una caja de conexiones de aluminio, integrada dentro de la superficie del sobre con tapa abatible. Su apertura se realiza estirando la tapa en dirección perpendicular y opuesta al top donde se ubica. En acabado blanco negro y gris.



PS0693

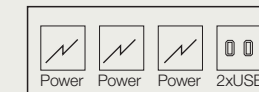

PS0694

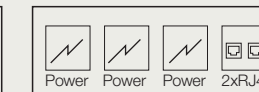

PS0800

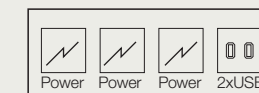

PS0799

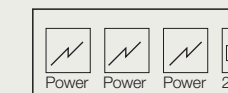

Wire management / Conectividad

Europe / RoW

Distribution
Distribución

- 1. System distribution:** As standard, the connection system will be located in the center of the table. For tables with more than one system, these will be placed with a separation of 1/3 of the total length of the table and in the longitudinal direction.
- 2. Wire management:** The cable leaves the power system, passes through an aluminum profile and travels down one of the bases, if there is a single base, the cable will exit directly from it.
- 3. Wire outlet:** The cable exits directly from the connection system through an aluminum profile that hides the wiring and down the inside one of the thermopolymer bases. If there is a single base, the cable will run directly through it, without using any aluminum profile, to the ground.

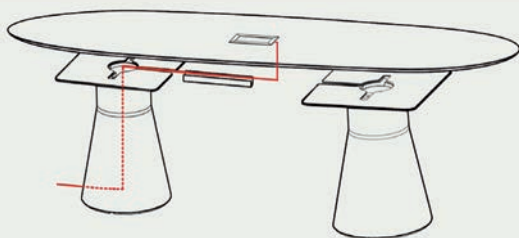
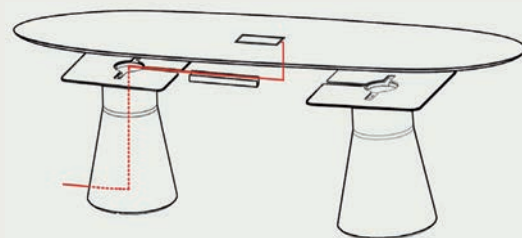
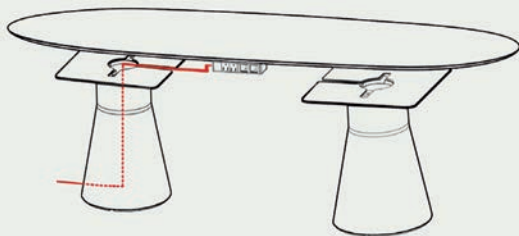
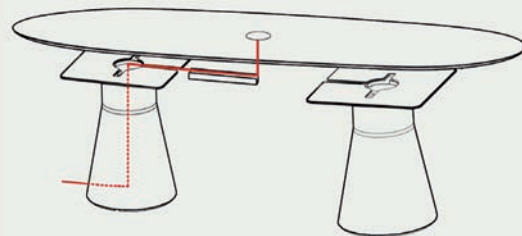
PS0710
PS0720PS0784
PS0785PS0787
PS0788PS0789
PS0790

PS0714

Wire management / Conectividad

Europe / RoW

Distribution
Distribución

- 1. Distribución de sistemas:** De serie, el sistema de conexiones se dispondrá en el centro de la mesa. Para las mesas con más de un sistema, estos se colocarán con una separación de 1/3 de la longitud total de la mesa y en sentido longitudinal.
- 2. Gestión del cableado:** El cable sale del sistema de electrificación, pasa a través de un perfil de aluminio y baja por una de las bases, si hay una única base, el cable saldrá directamente a través de esta.
- 3. Salida del cableado:** La salida del cable se realiza directamente desde el propio sistema de conexiones a través de un perfil de aluminio que oculta el cableado y baja por el interior de una de las bases de termopolímero. Si hay una única base, el cable saldrá directamente a través de esta, sin necesidad de utilizar ningún perfil de aluminio, hasta el suelo.

PS0715

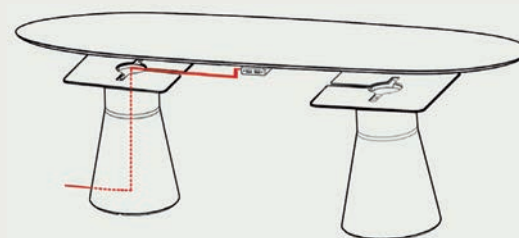

PS0718

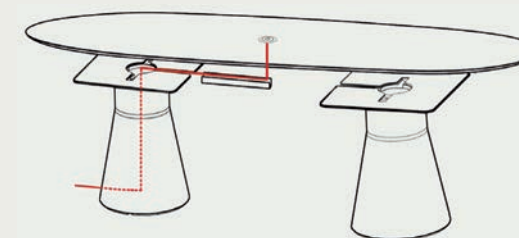
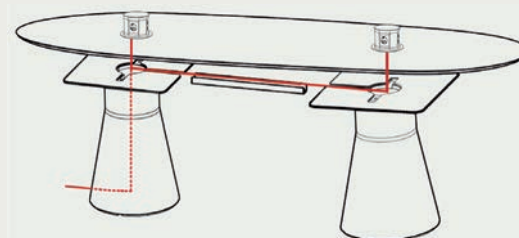
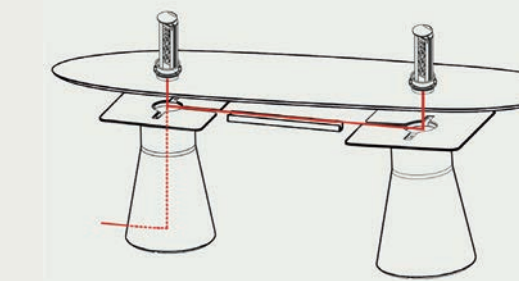
PS0692
PS0699PS0795
PS0796

Wire management / Conectividad

Europe / RoW

Distribution
Distribución

- 1. System distribution:** As standard, the connection system will be located in the center of the table. For tables with more than one system, these will be placed with a separation of 1/3 of the total length of the table and in the longitudinal direction.
- 2. Wire management:** The cable leaves the power system, passes through an aluminum profile and travels down one of the bases, if there is a single base, the cable will exit directly from it.
- 3. Wire outlet:** The cable exits directly from the connection system through an aluminum profile that hides the wiring and down the inside one of the thermopolymer bases. If there is a single base, the cable will run directly through it, without using any aluminum profile, to the ground.

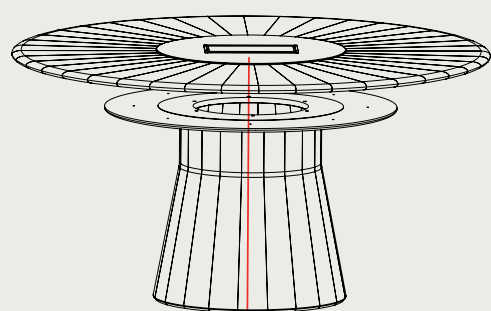
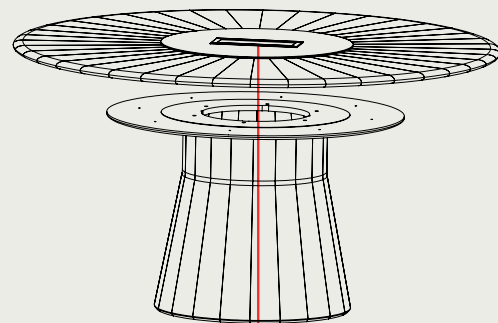
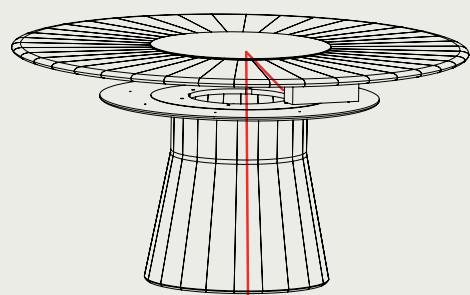
PS0710
PS0720PS0784
PS0785PS0787
PS0788PS0789
PS0790

PS0714

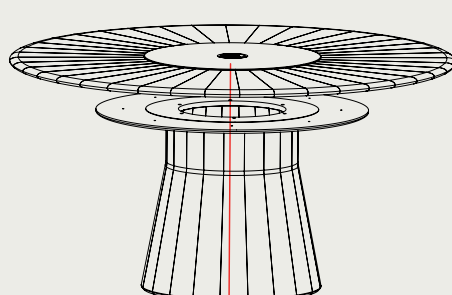

Wire management / Conectividad

Europe / RoW

Distribution
Distribución

- 1. Distribución de sistemas:** De serie, el sistema de conexiones se dispondrá en el centro de la mesa. Para las mesas con más de un sistema, estos se colocarán con una separación de 1/3 de la longitud total de la mesa y en sentido longitudinal.
- 2. Gestión del cableado:** El cable sale del sistema de electrificación, pasa a través de un perfil de aluminio y baja por una de las bases, si hay una única base, el cable saldrá directamente a través de esta.
- 3. Salida del cableado:** La salida del cable se realiza directamente desde el propio sistema de conexiones a través de un perfil de aluminio que oculta el cableado y baja por el interior de unas de las bases de termopolímero. Si hay una única base, el cable saldrá directamente a través de esta, sin necesidad de utilizar ningún perfil de aluminio, hasta el suelo.

PS0715

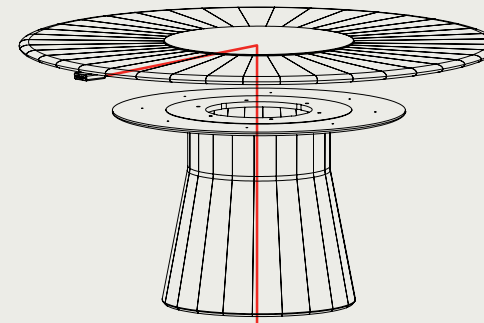

PS0718

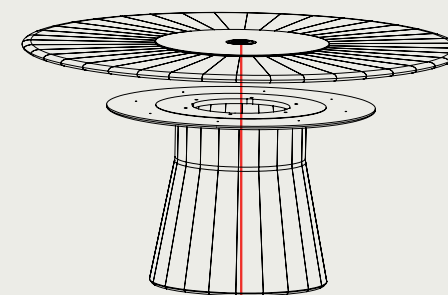
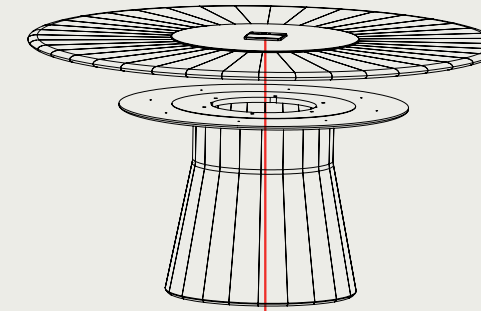
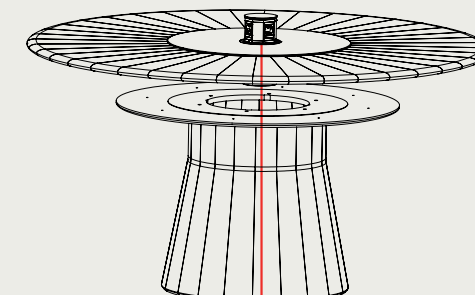
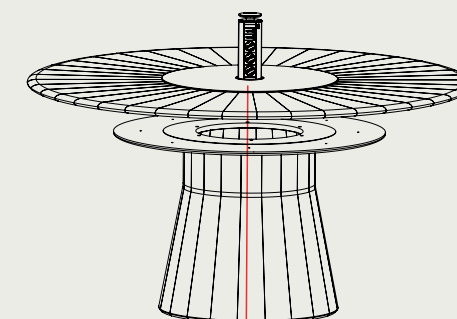
PS0692
PS0699PS0795
PS0796

Wire management / Conectividad

Europe / RoW

In surface
En superficie 

Integrated connection system

Composed of an interior cover with the same finish as the table top, and exterior frame in matt black finish. Its opening is made on both sides. Two system sizes are available, configurable from 2 + 2 or 3 + 3 where 1 or 2 power ports are included depending on the choice + 1 USB charging port and the rest are configurable, and may include MiniJack, VGA, HDMI, USB data ports or RJ45.

Sistema de conexiones integrado

Compuesto por una tapa interior con el mismo acabado que el sobre y un marco exterior de acabado negro mate. Su apertura se realiza en ambos lados. Se ofrecen dos tamaños de sistemas, configurables de 2+2 o 3+3 donde se incluyen 1 o 2 powers dependiendo de la elección + 1 USB de carga y los restantes son configurables, pudiendo incluir MiniJack, VGA, HDMI, USB de datos o RJ45.

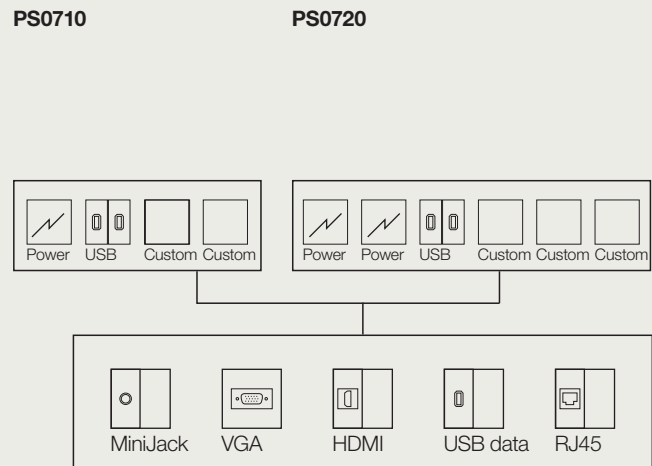

In surface
En superficie 

Integrated connection system

Composed of an interior cover with an exterior frame, both in anodized finish. Its opening is made by a soft touch. Two system sizes are available, configurable from 2 + 2 or 3 + 3 where 1 or 2 power ports are included depending on the choice + 1 USB charging port and the rest are configurable, and may include MiniJack, VGA, HDMI, USB data ports or RJ45.

Sistema de conexiones en superficie

Compuesto por una tapa interior y un marco exterior, ambos en acabado anodizado. Su apertura se realiza con una suave pulsación. Se ofrecen 2 tamaños de sistemas, configurables 2+2 o 3+3 donde se incluyen 2 o 3 powers dependiendo de la elección, y los restantes son configurables, pudiendo incluir MiniJack, VGA, HDMI, USB de datos o RJ 45.

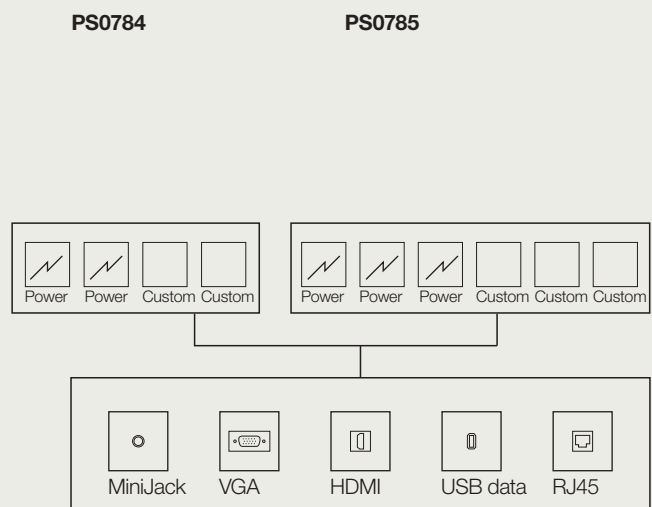

Wire management / Conectividad

Europe / RoW

Under top
Bajo sobre 

Under table top connection system

Composed of a profile, in two finishes, black or white. Several sizes and configurations are available depending on the needs, 2 + 2 or 3 + 3, where 1 or 2 powers + 1 USB double charging are included, or if USB charging is not required 2 or 3 powers, and the rest are configurable being able to include minijack and USB, VGA, HDMI and USB, 2 USB data or 2 RJ45. There is also a 1 + 1 version for small tables consisting of 1 power and the remaining configurable with minijack and USB, VGA, HDMI and USB, 2 USB data, 2 RJ45 or 2 USB charging.

Sistema de conexiones bajo el sobre

Compuesto por un perfil, en dos acabados, negro o blanco. Se ofrecen varios tamaños y configuraciones dependiendo de las necesidades, 2+2 o 3+3, donde se incluyen 1 o 2 powers + 1 USB de carga doble, o si no se requiere USB de carga 2 o 3 powers, y los restantes son configurables pudiendo incluir minijack y USB, VGA, HDMI and USB, 2 USB de datos o 2 RJ45. También hay una versión de 1+1 para mesas pequeñas compuesto por 1 power y el restante configurable con minijack y USB, VGA, HDMI and USB, 2 USB de datos, 2 RJ45 o 2 USB de carga.

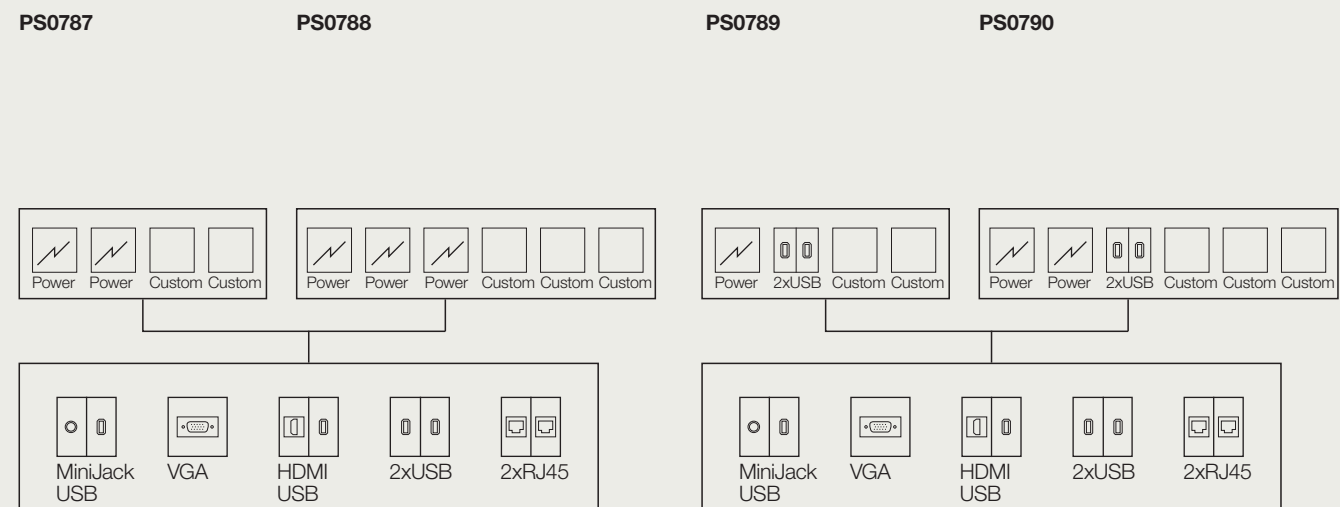

Wire management / Conectividad

Europe / RoW

Under top
Bajo sobre 

Under table top USB charging system

Composed of 2 USB charging, black or white. It is composed of two USB charging ports.

Sistema de USB de carga bajo el sobre

Compuesto por 2 USB de carga . Está disponible en dos acabados, negro y blanco.

In surface
En superficie 

USB charging system

Composed of 2 USB charging. It is available in two finishes, black and white.

Sistema de carga USB

Compuesto por 2 USB de carga . Está disponible en dos acabados, negro y blanco.

PS0715



PS0718



In surface
En superficie 

Qi charging system

Composed of a large surface for charging by induction, It is available in two finishes, black and white.

Sistema de carga Qi

Compuesto por una amplia superficie para cargar por inducción. Está disponible en dos acabados, negro y blanco.

PS0714



Wire management / Conectividad

Europe / RoW

In surface
En superficie 

Lifting connection system

Consisting of an aluminum junction box, integrated into the surface of the table top with hinged lid and the lid opens with gentle pressure. In anodized finish, for other finishes consult the Sales Department. Extraction connection systems.

Sistema de conexiones integrado

Compuesto por una caja de conexiones de aluminio, integrada dentro de la superficie del sobre con tapa abatible. su apertura se realiza con una suave pulsación. En acabado anodizado, para otros acabados consultar al Departamento Comercial. Sistemas de conexión de extracción.



PS0692

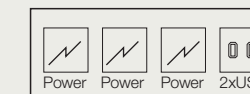

PS0699

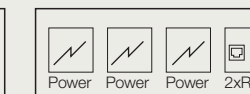

In surface
En superficie 

Lifting connection system

Consisting of an aluminum junction box, integrated into the surface of the table top with hinged lid. The lid is opened by pulling the lid in a perpendicular direction and opposite the top where it is located. In white black and gray finish.

Sistema de conexiones elevable

Compuesto por una caja de conexiones de aluminio, integrada dentro de la superficie del sobre con tapa abatible. Su apertura se realiza estirando la tapa en dirección perpendicular y opuesta al top donde se ubica. En acabado blanco negro y gris.



PS0796

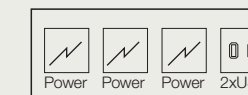

PS0795

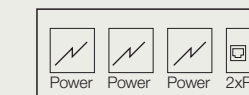

Reverse, an icon of elegance, is characterized for its aesthetic and functionality, offers an intermediate height base designed for more informal and relaxed applications. This piece combines seamlessly with lounge chairs, it is an invitation for teamwork and collective efforts. As in the other versions, Reverse Conference Lounge can accommodate an integrated connection system with various configurable options that allows intelligent use in corporate environments.

Reverse, un icono de elegancia, caracterizado por su estética y funcionalidad, presenta una altura de base intermedia pensada para un uso más informal y relajado. Esta pieza combinada con la utilización de butacas, es una invitación al trabajo en equipo y labores colaborativas. Como en el resto de versiones, Reverse Conference Lounge puede albergar un sistema de conexión integrado con diferentes opciones configurables que permite su uso inteligente en ambientes corporativos.

Reverse Conference Lounge

by Piergiorgio Cazzaniga



▼ **ME5732** / BU1694
Table with round cement top and cement central base.
Mesa con sobre redondo de cemento y base central de cemento.



▼ **ME5018**
Table with elliptical lacquered top and two central bases.
Mesa con sobre elíptico lacado y dos bases centrales.



Conference room
Sala de reunión
▼ **ME5537** / BU1264
Table with round glass top and one central base.
Mesa con sobre redondo de cristal y una base central.



Tops / Sobres

Table program available with different types of board table tops of different shapes and sizes, available in oak, lacquered, laminated, TP laminate, technical stone 8, glass, linoleum, ultra-matte and cement finishes. Table program suitable for different types of polyethylene central bases available in various colors and cement finish.

Programa de mesas disponible con diferentes tipos de sobres de mesa de tablero de diferentes formas y medidas, disponibles en acabado roble, lacado, laminado, laminado TP, technical stone 8, cristal, linóleo, ultramatte y cemento.

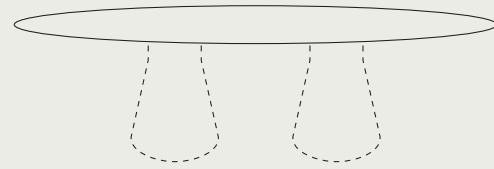

Oak Roble

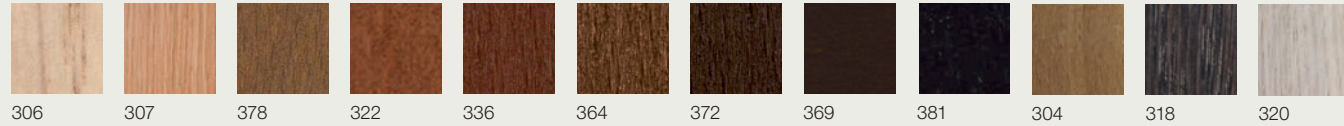

306 307 378 322 336 364 372 369 381 304 318 320

Premium finishes and wood lacquers Acabados premium y lacados



610 641 645L Sand Arena NCS 4005-Y20R Basalt grey Gris basalto 605L NCS S 6502-B Dark grey Gris oscuro 380 661 Red Rojo 642L Cayenne red Rojo cayena 606L RAL 1005 Yellow mustard Amarillo mostaza

Laminate Laminado

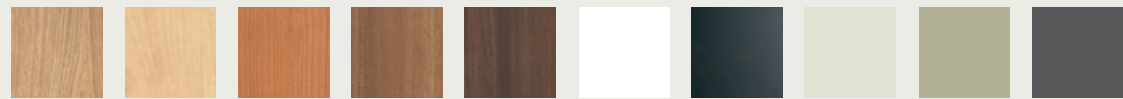

L205 Oak Roble L204 Maple Arce L203 Cherry Cerezo L202 Walnut Nogal L206 Dark walnut Nogal oscuro L200 White Blanco L201 Black Negro L300 Sand Arena L302 Basalt grey Gris basalto L301 Dark grey Gris oscuro

Glass Cristal



White Blanco Sand Arena Basalt grey Gris basalto Cayenne red Rojo cayena Dark grey Gris oscuro Matte black Negro mate

Technical stone 8

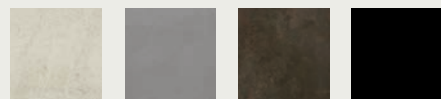

DKAR Sand Arena DKRC Rock grey Gris roca DKMR Earth brown Marrón tierra DKNG Black Negro

Linoleum Linóleo



L315 Ivory Marfil L316 Black Negro L310 White Blanco L311 Black Negro

Ultra-matte Ultramatte



L315 Ivory Marfil L316 Black Negro L310 White Blanco L311 Black Negro

Cement Cemento

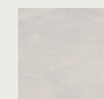

Cement

Tops / Sobres

Top 30 Razor

30mm./1.18in. thick table top and bevelled edge. Sobre de mesa de 30mm./1.18in. de espesor y con canto biselado.

Oak / Roble
Laminated / Laminado
Lacquered / Lacado
Linoleum / Linóleo
Ultra-matte / Ultramatte
Cement / Cemento
Technical stone 8



Top 30 Razor TP

30mm./1.18in. thick table top and matching thermopolymer bevelled edge. Sobre de mesa de 30mm./1.18in. de espesor y con canto de termopolimero a juego.

Laminated TP / Laminado TP
Ultra-matte TP / Ultramatte TP



Top Glass 35

36mm./1.4in. thick table top, with 6mm./0.2in. tempered glass + 30mm./1.2in. substrate. Sobre de mesa de 36mm./1.4in. de espesor, con cubierta de cristal templado de 6mm./0.2in. + sustrato de 30mm./1.2in.



Bases

Table program suitable for different types of polyethylene central bases available in various colors and cement finish.

Programa de mesas apto para diferentes tipos de bases centrales de polietileno disponible en varios colores y acabado cemento.

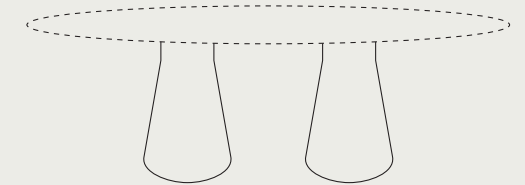

Polyethylene Polietileno



6000 White Blanco 6002 Sand Arena 6012 Basalt grey Gris basalto 6006 Black Negro 6013 Dark Grey Gris oscuro

Cement Cemento

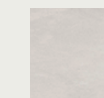

Cement

Meeting tables
Mesas de reunión

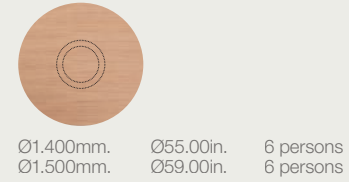
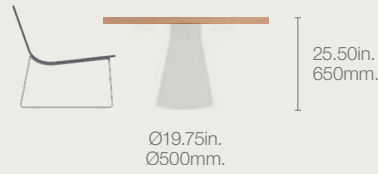

Meeting tables
Mesas de reunión

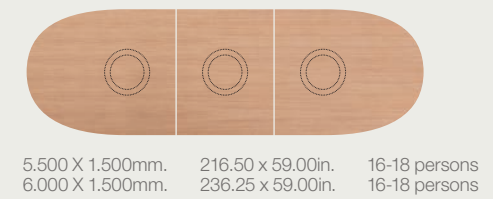
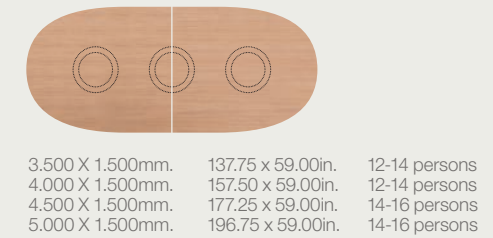

Wire management / Conectividad

America

**Distribution
Distribución**

1. **System distribution:** As standard, the connection system will be located in the center of the table. For tables with more than one system, these will be placed with a separation of 1/3 of the total length of the table and in the longitudinal direction.
2. **Wire management:** The cable leaves the power system, passes through an aluminum profile and travels down one of the bases, if there is a single base, the cable will exit directly from it.
3. **Wire outlet:** The cable exits directly from the connection system through an aluminum profile that hides the wiring and down the inside one of the thermopolymer bases. If there is a single base, the cable will run directly through it, without using any aluminum profile, to the ground.

PS0711
PS0721

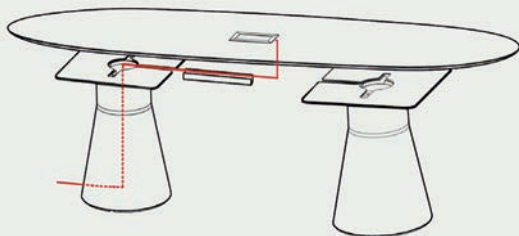

PS0752
PS0753

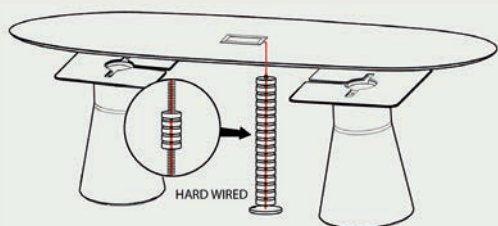
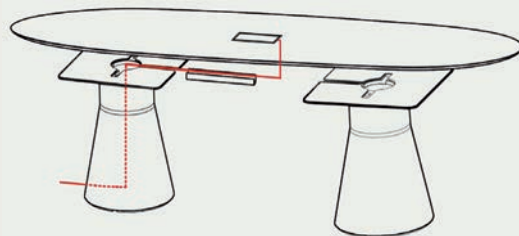

Hard wired, applicable to PS0752 and PS0753. They are offered as an extra option.
Hard wired, aplicable a PS0752 y PS0753. Se ofrecen como una opción extra.

PS0755
PS0756

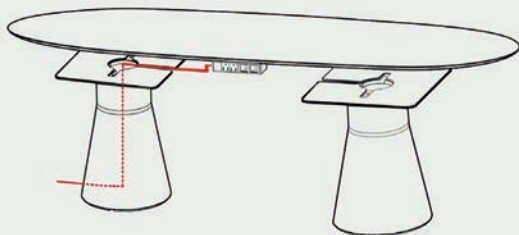

PS0713

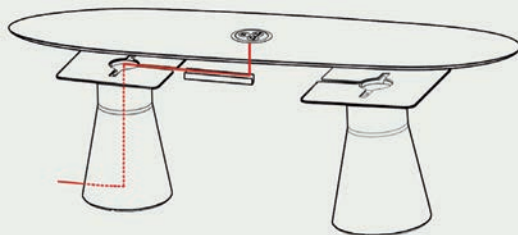

PS0750
PS0751

Wire management / Conectividad

America

**Distribution
Distribución**

1. **Distribución de sistemas:** De serie, el sistema de conexiones se dispondrá en el centro de la mesa. Para las mesas con más de un sistema, estos se colocarán con una separación de 1/3 de la longitud total de la mesa y en sentido longitudinal.
2. **Gestión del cableado:** El cable sale del sistema de electrificación, pasa a través de un perfil de aluminio y baja por una de las bases, si hay una única base, el cable saldrá directamente a través de esta.
3. **Salida del cableado:** La salida del cable se realiza directamente desde el propio sistema de conexiones a través de un perfil de aluminio que oculta el cableado y baja por el interior de unas de las bases de termopolímero. Si hay una única base, el cable saldrá directamente a través de esta, sin necesidad de utilizar ningún perfil de aluminio, hasta el suelo.

PS0715

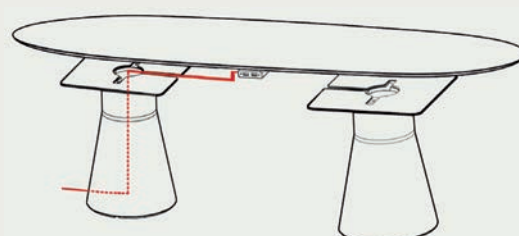

PS0716
PS0717

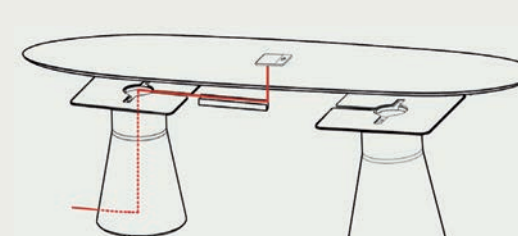

PS0693
PS0694

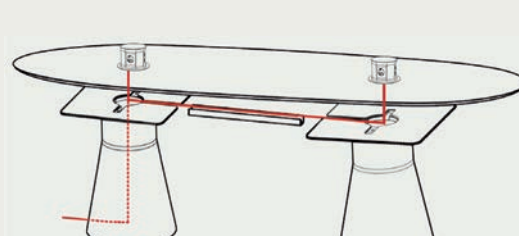

PS0800
PS0799

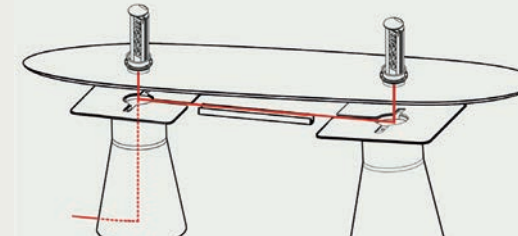

PS0718

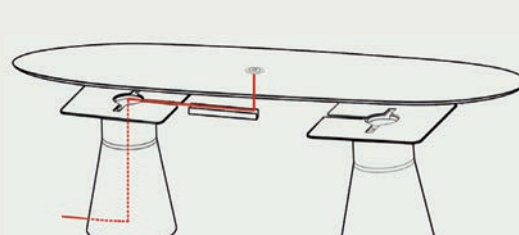

Wire management / Conectividad

America

In surface
En superficie



Integrated connection system

Composed of an interior cover with the same finish as the table top, and exterior frame in matt black finish. Its opening is made on both sides. Two system sizes are available, configurable from 2 + 2 or 3 + 3 where 1 or 2 power ports are included depending on the choice + 1 USB charging port and the rest are configurable, and may include MiniJack, VGA, HDMI, USB data ports or RJ45.

Sistema de conexiones integrado

Compuesto por una tapa interior con el mismo acabado que el sobre y un marco exterior de acabado negro mate. Su apertura se realiza en ambos lados. Se ofrecen dos tamaños de sistemas, configurables de 2+2 o 3+3 donde se incluyen 1 o 2 powers dependiendo de la elección + 1 USB de carga y los restantes son configurables, pudiendo incluir MiniJack, VGA, HDMI, USB de datos o RJ45.



PS0711

PS0721

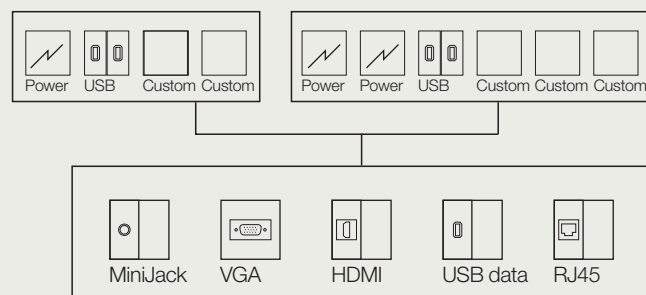

In surface
En superficie



Surface connection system

Composed of an interior cover with an exterior frame, both in anodized finish. Its opening is made by a soft touch. Two system sizes are available, configurable from 2 + 2 or 3 + 3 where 2 or 3 power ports are included depending on the choice and the rest are configurable, and may include MiniJack, VGA, HDMI, USB data ports or RJ45.

Sistema de conexiones integrado

Compuesto por una tapa interior y un marco exterior, ambos en acabado anodizado. Su apertura se realiza con una suave pulsación. Se ofrecen 2 tamaños de sistemas, configurables 2+2 o 3+3 donde se incluyen 2 o 3 powers dependiendo de la elección, y los restantes son configurables, pudiendo incluir MiniJack, VGA, HDMI, USB de datos o RJ 45.



PS0752

PS0753

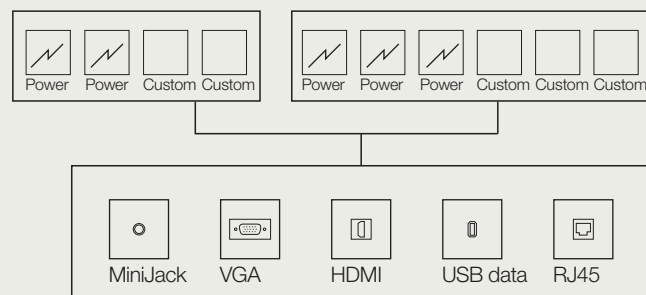

Wire management / Conectividad

America

Under top
Bajo sobre



Under table top connection system

Composed of a profile, in two finishes, black or white. Several sizes and configurations are available depending on the needs, 2 + 2 or 3 + 3, where 1 or 2 powers + 1 USB double charging are included, or if USB charging is not required 2 or 3 powers, and the rest are configurable being able to include miniJack and USB, VGA, HDMI and USB, 2 USB data or 2 RJ45. There is also a 1 + 1 version for small tables consisting of 1 power and the remaining configurable with miniJack and USB, VGA, HDMI and USB, 2 USB data, 2 RJ45 or 2 USB charging.

Sistema de conexiones bajo el sobre

Compuesto por un perfil, en dos acabados, negro o blanco. Se ofrecen varios tamaños y configuraciones dependiendo de las necesidades, 2+2 o 3+3, donde se incluyen 1 o 2 powers + 1 USB de carga doble, o si no se requiere USB de carga 2 o 3 powers, y los restantes son configurables pudiendo incluir miniJack y USB, VGA, HDMI and USB, 2 USB de datos o 2 RJ45. También hay una versión de 1+1 para mesas pequeñas compuesto por 1 power y el restante configurable con miniJack y USB, VGA, HDMI and USB, 2 USB de datos, 2 RJ45 o 2 USB de carga.



PS0755

PS0756

PS0750

PS0751

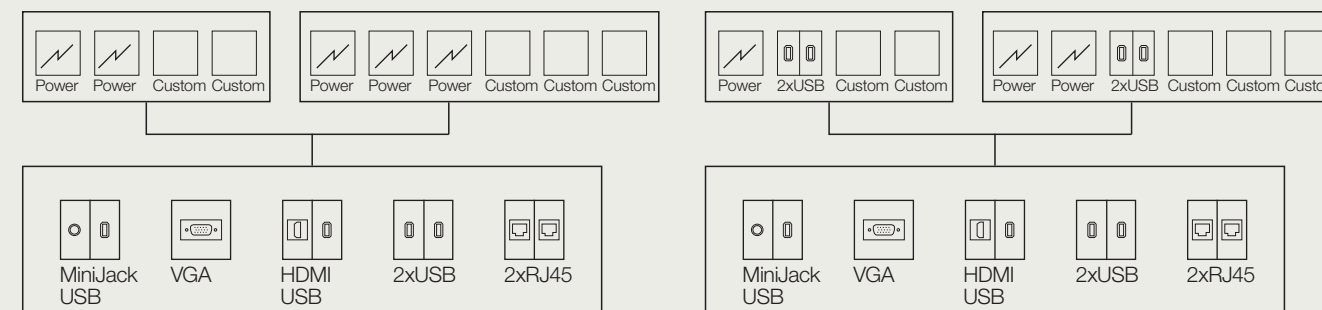

Wire management / Conectividad

America

In surface
En superficie 

Integrated connection system

Composed of 2 powers and 2 USB charging. The system turns on itself and remains hidden when it is not in use. It is available in two finishes, black and white.

Sistema de conexiones integrado

Compuesto por 2 powers y 2 USB de carga. El sistema gira sobre si mismo y permanecer oculto cuando no este en uso. Está disponible en dos acabados, negro y blanco.

PS0713



In surface
En superficie 

Qi charging system

Composed of a large surface for charging by induction, 1 power + 1USB charging (PS 0716) or 2USB charging (PS 0717). It is available in two finishes, black and white.

Sistema de carga Qi

Compuesto por una amplia superficie para cargar por inducción, 1 power+ 1USB de carga (PS 0716) o 2 USB de carga (PS 0717). Está disponible en dos acabados, negro y blanco.

PS0716 / PS0717



In surface
En superficie 

USB charging system

Composed of 2 USB charging. It is available in two finishes, black and white.

Sistema de carga USB

Compuesto por 2 USB de carga. Está disponible en dos acabados, negro y blanco.

PS0718



Under top
Bajo sobre 

Under table top USB charging system

Composed of 2 USB charging, black or white.

Sistema de USB de carga bajo el sobre

Compuesto por 2 USB de carga. Está disponible en dos acabados, negro y blanco.

PS0715



Wire management / Conectividad

America

In surface
En superficie 

Lifting connection system

Consisting of an aluminum junction box, integrated into the surface of the table top with hinged lid and the lid opens with gentle pressure. In anodized finish, for other finishes consult the Sales Department. Extraction connection systems.

Sistema de conexiones integrado

Compuesto por una caja de conexiones de aluminio, integrada dentro de la superficie del sobre con tapa abatible. su apertura se realiza con una suave pulsación. En acabado anodizado, para otros acabados consultar al Departamento Comercial. Sistemas de conexión de extracción.



In surface
En superficie 

Lifting connection system

Consisting of an aluminum junction box, integrated into the surface of the table top with hinged lid. The lid is opened by pulling the lid in a perpendicular direction and opposite the top where it is located. In white black and gray finish.

Sistema de conexiones elevable

Compuesto por una caja de conexiones de aluminio, integrada dentro de la superficie del sobre con tapa abatible. Su apertura se realiza estirando la tapa en dirección perpendicular y opuesta al top donde se ubica. En acabado blanco negro y gris.



PS0693

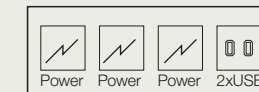

PS0694

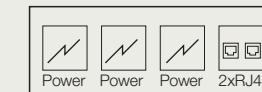

PS0800

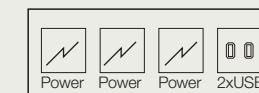

PS0799

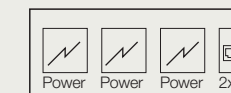

Wire management / Conectividad

Europe / RoW

Distribution
Distribución

- 1. System distribution:** As standard, the connection system will be located in the center of the table. For tables with more than one system, these will be placed with a separation of 1/3 of the total length of the table and in the longitudinal direction.
- 2. Wire management:** The cable leaves the power system, passes through an aluminum profile and travels down one of the bases, if there is a single base, the cable will exit directly from it.
- 3. Wire outlet:** The cable exits directly from the connection system through an aluminum profile that hides the wiring and down the inside one of the thermopolymer bases. If there is a single base, the cable will run directly through it, without using any aluminum profile, to the ground.

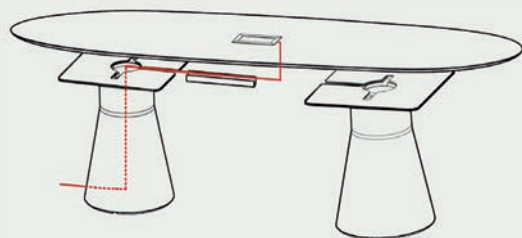
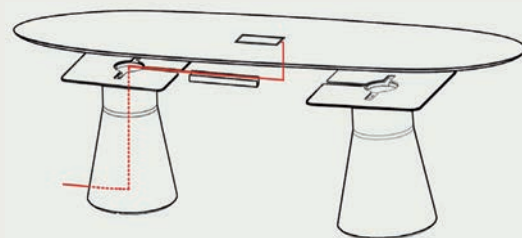
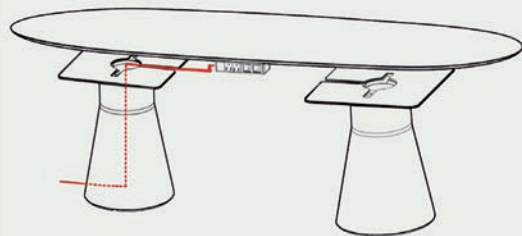
PS0710
PS0720PS0784
PS0785PS0787
PS0788

PS0713

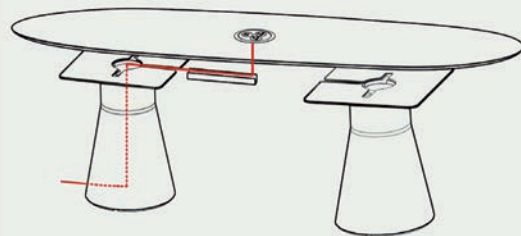
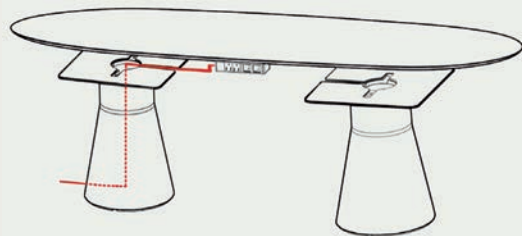
PS0789
PS0790

Wire management / Conectividad

Europe / RoW

Distribution
Distribución

- 1. Distribución de sistemas:** De serie, el sistema de conexiones se dispondrá en el centro de la mesa. Para las mesas con más de un sistema, estos se colocarán con una separación de 1/3 de la longitud total de la mesa y en sentido longitudinal.
- 2. Gestión del cableado:** El cable sale del sistema de electrificación, pasa a través de un perfil de aluminio y baja por una de las bases, si hay una única base, el cable saldrá directamente a través de esta.
- 3. Salida del cableado:** La salida del cable se realiza directamente desde el propio sistema de conexiones a través de un perfil de aluminio que oculta el cableado y baja por el interior de unas de las bases de termopolímero. Si hay una única base, el cable saldrá directamente a través de esta, sin necesidad de utilizar ningún perfil de aluminio, hasta el suelo.

PS0714

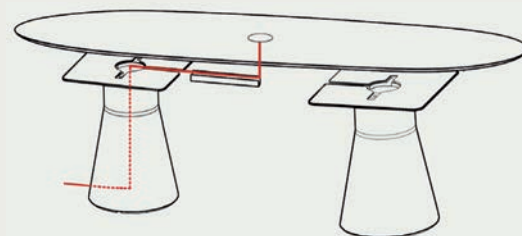

PS0715

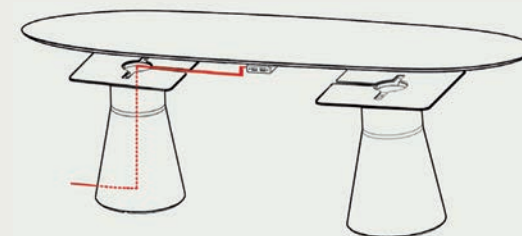
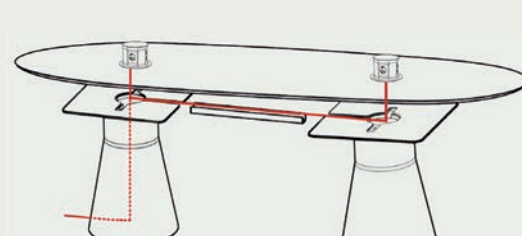
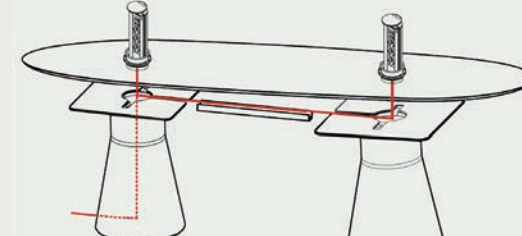
PS0692
PS0699PS0796
PS0795

PS0718

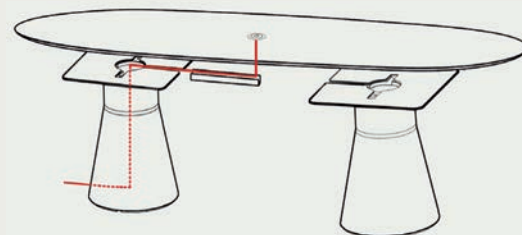

Wire management / Conectividad

Europe / RoW

In surface
En superficie 

Integrated connection system

Composed of an interior cover with the same finish as the table top, and exterior frame in matt black finish. Its opening is made on both sides. Two system sizes are available, configurable from 2 + 2 or 3 + 3 where 1 or 2 power ports are included depending on the choice + 1 USB charging port and the rest are configurable, and may include MiniJack, VGA, HDMI, USB data ports or RJ45.

Sistema de conexiones integrado

Compuesto por una tapa interior con el mismo acabado que el sobre y un marco exterior de acabado negro mate. Su apertura se realiza en ambos lados. Se ofrecen dos tamaños de sistemas, configurables de 2+2 o 3+3 donde se incluyen 1 o 2 powers dependiendo de la elección + 1 USB de carga y los restantes son configurables, pudiendo incluir MiniJack, VGA, HDMI, USB de datos o RJ45.

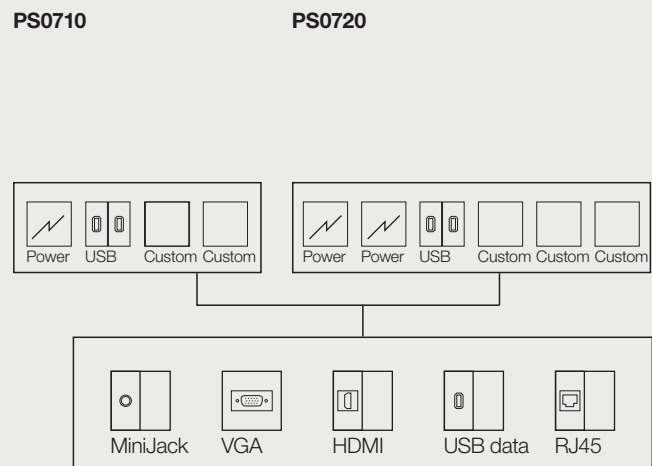

In surface
En superficie 

Integrated connection system

Composed of an interior cover with an exterior frame, both in anodized finish. Its opening is made by a soft touch. Two system sizes are available, configurable from 2 + 2 or 3 + 3 where 1 or 2 power ports are included depending on the choice + 1 USB charging port and the rest are configurable, and may include MiniJack, VGA, HDMI, USB data ports or RJ45.

Sistema de conexiones en superficie

Compuesto por una tapa interior y un marco exterior, ambos en acabado anodizado. Su apertura se realiza con una suave pulsación. Se ofrecen 2 tamaños de sistemas, configurables 2+2 o 3+3 donde se incluyen 2 o 3 powers dependiendo de la elección, y los restantes son configurables, pudiendo incluir MiniJack, VGA, HDMI, USB de datos o RJ 45.

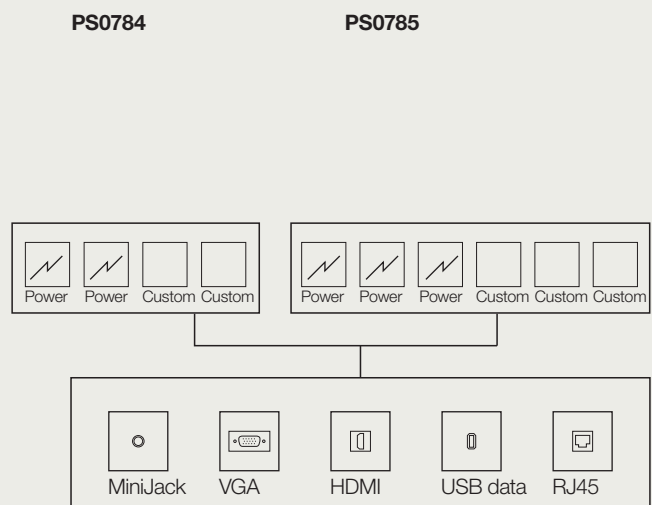

Wire management / Conectividad

Europe / RoW

Under top
Bajo sobre 

Under table top connection system

Composed of a profile, in two finishes, black or white. Several sizes and configurations are available depending on the needs, 2 + 2 or 3 + 3, where 1 or 2 powers + 1 USB double charging are included, or if USB charging is not required 2 or 3 powers, and the rest are configurable being able to include minijack and USB, VGA, HDMI and USB, 2 USB data or 2 RJ45. There is also a 1 + 1 version for small tables consisting of 1 power and the remaining configurable with minijack and USB, VGA, HDMI and USB, 2 USB data, 2 RJ45 or 2 USB charging.

Sistema de conexiones bajo el sobre

Compuesto por un perfil, en dos acabados, negro o blanco. Se ofrecen varios tamaños y configuraciones dependiendo de las necesidades, 2+2 o 3+3, donde se incluyen 1 o 2 powers + 1 USB de carga doble, o si no se requiere USB de carga 2 o 3 powers, y los restantes son configurables pudiendo incluir minijack y USB, VGA, HDMI and USB, 2 USB de datos o 2 RJ45. También hay una versión de 1+1 para mesas pequeñas compuesto por 1 power y el restante configurable con minijack y USB, VGA, HDMI and USB, 2 USB de datos, 2 RJ45 o 2 USB de carga.

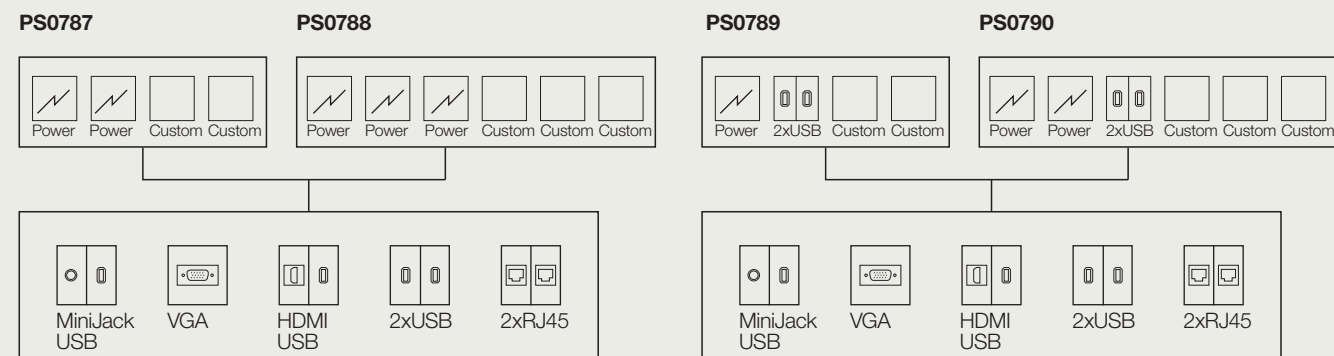

Wire management / Conectividad

Europe / RoW

Under top
Bajo sobre 

Under table top USB charging system

Composed of 2 USB charging, black or white.

Sistema de USB de carga bajo el sobre

Compuesto por 2 USB de carga . Está disponible en dos acabados, negro y blanco.

In surface
En superficie 

USB charging system

Composed of 2 USB charging. It is available in two finishes, black and white.

Sistema de carga USB

Compuesto por 2 USB de carga . Está disponible en dos acabados, negro y blanco.

PS0715



PS0718



In surface
En superficie 

Qi charging system

Composed of a large surface for charging by induction, . It is available in two finishes, black and white.

Sistema de carga Qi

Compuesto por una amplia superficie para cargar por inducción. Está disponible en dos acabados, negro y blanco.

PS0714



Wire management / Conectividad

Europe / RoW

In surface
En superficie 

Lifting connection system

Consisting of an aluminum junction box, integrated into the surface of the table top with hinged lid and the lid opens with gentle pressure. In anodized finish, for other finishes consult the Sales Department. Extraction connection systems.

Sistema de conexiones integrado

Compuesto por una caja de conexiones de aluminio, integrada dentro de la superficie del sobre con tapa abatible. su apertura se realiza con una suave pulsación. En acabado anodizado, para otros acabados consultar al Departamento Comercial. Sistemas de conexión de extracción.

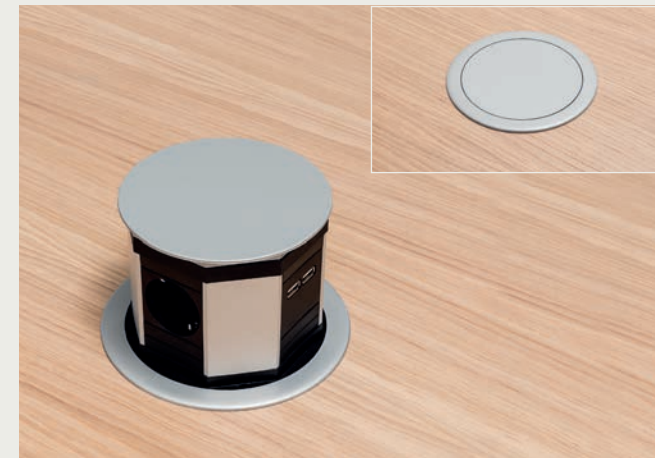

PS0692

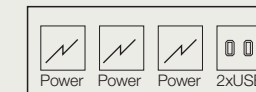

PS0699

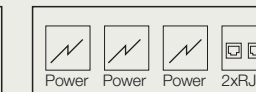

In surface
En superficie 

Lifting connection system

Consisting of an aluminum junction box, integrated into the surface of the table top with hinged lid. The lid is opened by pulling the lid in a perpendicular direction and opposite the top where it is located. In white black and gray finish.

Sistema de conexiones elevable

Compuesto por una caja de conexiones de aluminio, integrada dentro de la superficie del sobre con tapa abatible. Su apertura se realiza estirando la tapa en dirección perpendicular y opuesta al top donde se ubica. En acabado blanco negro y gris.



PS0796

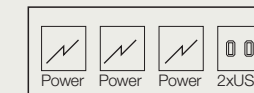

PS0795

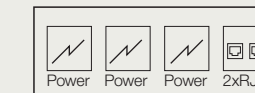

SP is a flexible, multipurpose wood table system that can adapt to the most diverse environments thanks to its different shapes, sizes and heights. The SP Collection is the perfect solution for offices, public spaces or waiting rooms.

SP es un sistema de mesas flexible y polivalente, capaz de adaptarse a los ambientes más diversos a partir de su oferta de distintas formas, longitudes y alturas. Es una solución perfecta para oficinas, espacios públicos o zonas de espera.

Sistema SP

by Lievore Altherr Molina



**Restaurant
Restaurante**

◀ SB7139 + BM7215 / SO0595

Table with square maple top with
four beech legs.Mesa con sobre cuadrado de arce
con cuatro pies de haya.**Conference room
Sala de reunión**

▼ SB7150 + BM7215 / SO0455

Table with rectangular maple top
with four beech legs.Mesa con sobre rectangular de
arce con cuatro pies de haya.



◀ **SB7158 + BM7217**

Occasional table. Table with square maple top with four beech legs.
Mesa auxiliar. Mesa con sobre cuadrado de arce con cuatro pies de haya.

◀ **SB7150 + BM7215**

Table with rectangular maple top with four beech legs.
Mesa con sobre rectangular de arce con cuatro pies de haya.

◀ **SB7234 + BM7183**

Occasional table. Table with square lacquered top with four beech legs.
Mesa ocasional. Mesa con sobre cuadrado lacado con cuatro pies de haya.

Residencial

Hogar

◀ **SB7150 + BM7215** / SO0902

Table with rectangular maple top with four beech legs.
Mesa con sobre rectangular de arce con cuatro pies de haya.

Residencial

Hogar

▼ **SB7233 + BM7184** / SO0583

Table with lacquered square top and legs.
Mesa con sobre cuadrado y pies lacadas.



Tops / Sobres

Collection of table tops made of maple veneer and solid beech legs available in three heights. Can be combined with any model from our Top SP 40 collection.

Sistema de sobres de mesa chapados en arce con cantos macizos y estructura de pies de madera maciza de haya en tres alturas. Permite diferentes combinaciones. Combinables con sobres de mesa de la colección Top SP 40.

Beech Haya

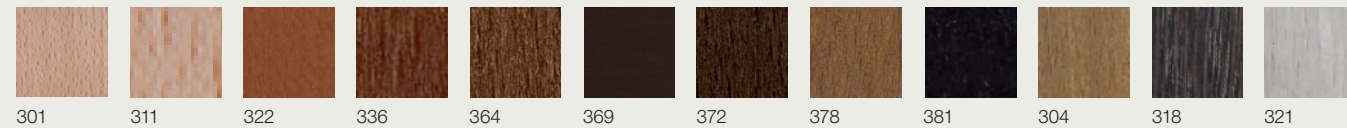

Premium finishes and wood lacquers Acabados premium y lacados



Ultra-matte Ultramate

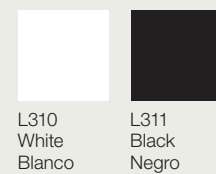

Laminate / Laminado TP Laminado / Laminado TP

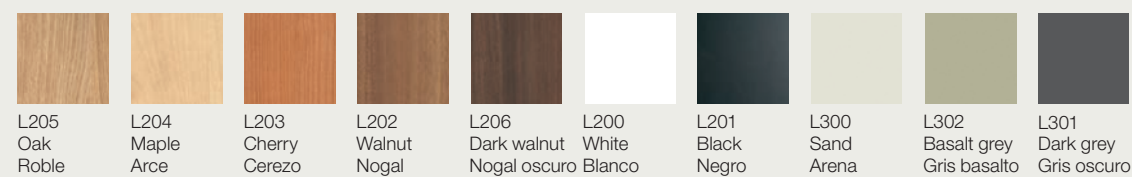

Sistema SP table tops / Sobres de mesa Sistema SP

Top SP 40

40 mm. / 1.18 in thick laminated table top and matching thermopolymer edge. Sobre de mesa laminado de 40 mm. / 1.18 in y con canto de termopolímero a juego.

Laminated / Laminado
Lacquered / Lacado
Linoleum / Linóleo
Ultra-matte / Ultramate

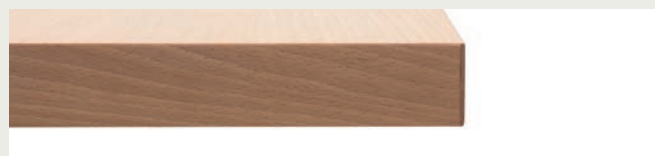

Legs / Pies

Set (4 units of 300mm., 550mm. or 700mm. height) Includes aluminum hardware to join feet with top.

Juego (4 unidades de 300mm., 550mm. o 700mm. de altura. Incluye herraje de aluminio para unir pies con sobre.

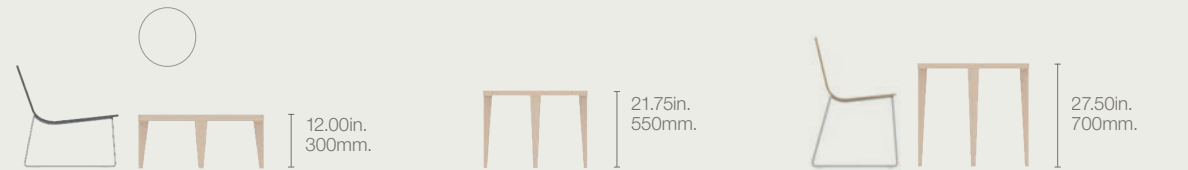

Maximum table top Ø23.75
Maximum table top Ø27.50
Maximum table top Ø31.50
Maximum table top Ø35.50
Maximum table top Ø39.50
Maximum table top Ø43.25
Maximum table top Ø47.25
Maximum table top Ø51.25
Maximum table top Ø55.25
Maximum table top Ø59.00

Medida máxima de sobre Ø600
Medida máxima de sobre Ø700
Medida máxima de sobre Ø800
Medida máxima de sobre Ø900
Medida máxima de sobre Ø1.000
Medida máxima de sobre Ø1.100
Medida máxima de sobre Ø1.200
Medida máxima de sobre Ø1.300
Medida máxima de sobre Ø1.400
Medida máxima de sobre Ø1.500

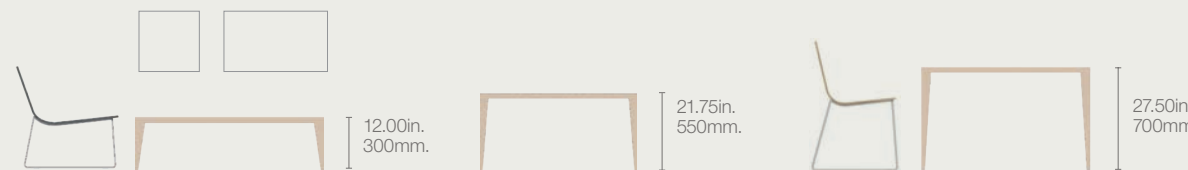

Maximum table top 15.75 x 15.75
Maximum table top 23.75 x 23.75
Maximum table top 27.50 x 27.50
Maximum table top 31.50 x 31.50
Maximum table top 35.50 x 35.50
Maximum table top 39.50 x 39.50
Maximum table top 43.25 x 43.25
Maximum table top 47.25 x 47.25
Maximum table top 51.25 x 51.25
Maximum table top 55.25 x 55.25
Maximum table top 59.00 x 59.00

Medida máxima de sobre 400 x 400
Medida máxima de sobre 600 x 600
Medida máxima de sobre 700 x 700
Medida máxima de sobre 800 x 800
Medida máxima de sobre 900 x 900
Medida máxima de sobre 1.000 x 1.000
Medida máxima de sobre 1.100 x 1.100
Medida máxima de sobre 1.200 x 1.200
Medida máxima de sobre 1.300 x 1.300
Medida máxima de sobre 1.400 x 1.400
Medida máxima de sobre 1.500 x 1.500

Maximum table top 27.50 x 23.75
Maximum table top 31.50 x 23.75
Maximum table top 31.50 x 27.50
Maximum table top 1.200 x 27.50
Maximum table top 59.00 x 35.50
Maximum table top 1.850 x 35.50
Maximum table top 78.75 x 39.50

Medida máxima de sobre 700 x 600
Medida máxima de sobre 800 x 600
Medida máxima de sobre 800 x 700
Medida máxima de sobre 1.200 x 700
Medida máxima de sobre 1.500 x 900
Medida máxima de sobre 1.850 x 900
Medida máxima de sobre 2.000 x 1.000

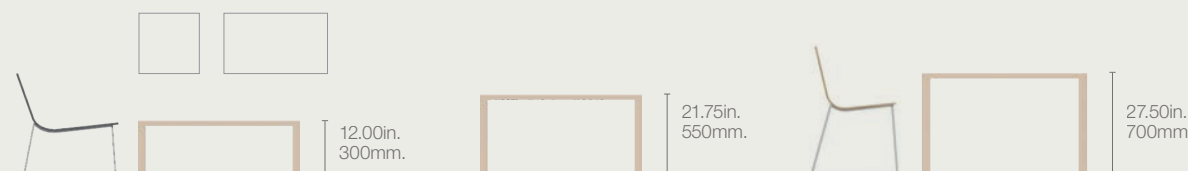

Maximum table top 15.75 x 15.75
Maximum table top 23.75 x 23.75
Maximum table top 27.50 x 27.50
Maximum table top 31.50 x 31.50
Maximum table top 35.50 x 35.50
Maximum table top 39.50 x 39.50
Maximum table top 43.25 x 43.25
Maximum table top 47.25 x 47.25
Maximum table top 51.25 x 51.25
Maximum table top 55.25 x 55.25
Maximum table top 59.00 x 59.00

Medida máxima de sobre 400 x 400
Medida máxima de sobre 600 x 600
Medida máxima de sobre 700 x 700
Medida máxima de sobre 800 x 800
Medida máxima de sobre 900 x 900
Medida máxima de sobre 1.000 x 1.000
Medida máxima de sobre 1.100 x 1.100
Medida máxima de sobre 1.200 x 1.200
Medida máxima de sobre 1.300 x 1.300
Medida máxima de sobre 1.400 x 1.400
Medida máxima de sobre 1.500 x 1.500

Maximum table top 27.50 x 23.75
Maximum table top 31.50 x 23.75
Maximum table top 31.50 x 27.50
Maximum table top 47.25 x 27.50
Maximum table top 59.00 x 35.50
Maximum table top 73.00 x 35.50
Maximum table top 78.75 x 39.50

Medida máxima de sobre 700 x 600
Medida máxima de sobre 800 x 600
Medida máxima de sobre 800 x 700
Medida máxima de sobre 1.200 x 700
Medida máxima de sobre 1.500 x 900
Medida máxima de sobre 1.850 x 900
Medida máxima de sobre 2.000 x 1.000

Wire management / Conectividad

America

Distribution Distribución

- 1. System distribution:** As standard, the connection system will be located in the center of the table. For tables with more than one system, these will be placed with a separation of 1/3 of the total length of the table and in the longitudinal direction.
- 2. Wire management:** The cable leaves the power system and passes through a snake.
- 3. Wire outlet:** The cable exits directly from the connection system through a snake that permits the changing of the final position of the wiring until it reaches the ground.

PS0711
PS0721

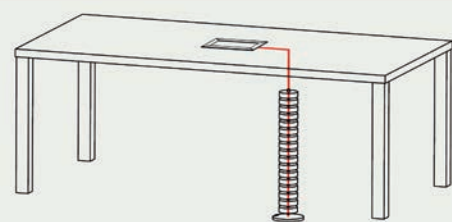
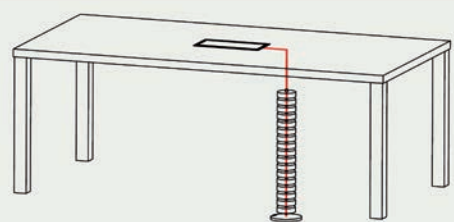

PS0752
PS0753

PS0755
PS0756

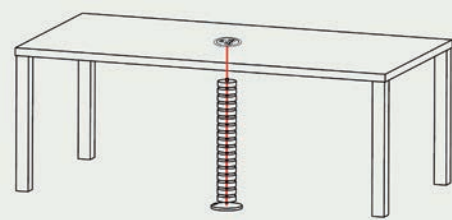
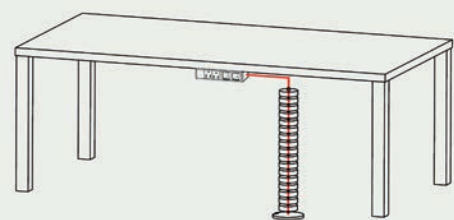

PS0713

PS0750
PS0751

Wire management / Conectividad

America

Distribution Distribución

- 1. Distribución de sistemas:** De serie, el sistema de conexiones se dispondrá en el centro de la mesa. Para las mesas con más de un sistema, estos se colocarán con una separación de 1/3 de la longitud **total de la mesa y en sentido longitudinal**.
- 2. Gestión del cableado:** El cable sale del sistema de electrificación y pasa a través de un snake.
- 3. Salida del cableado:** La salida del cable se realiza directamente desde el propio sistema de conexiones a través de un snake que permite cambiar la posición final del cableado hasta llegar al suelo.

PS0714

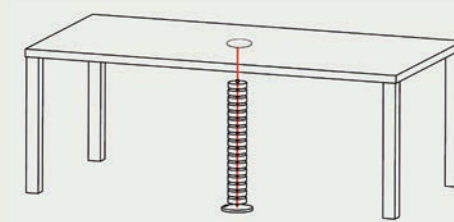

PS0715

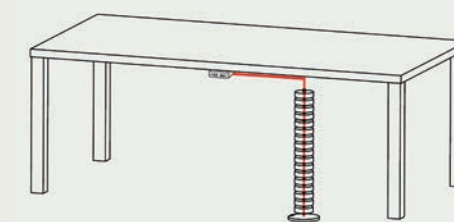

PS0716
PS0717

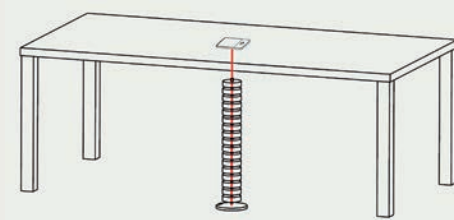

PS0718

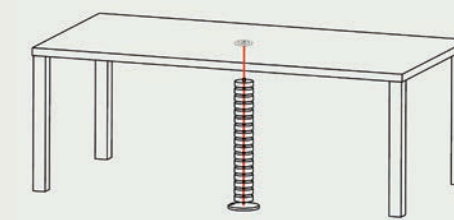

Wire management / Conectividad

America

In surface
En superficie



Integrated connection system

Composed of an interior cover with the same finish as the table top, and exterior frame in matt black finish. Its opening is made on both sides. Two system sizes are available, configurable from 2 + 2 or 3 + 3 where 1 or 2 power ports are included depending on the choice + 1 USB charging port and the rest are configurable, and may include MiniJack, VGA, HDMI, USB data ports or RJ45.

Sistema de conexiones integrado

Compuesto por una tapa interior con el mismo acabado que el sobre y un marco exterior de acabado negro mate. Su apertura se realiza en ambos lados. Se ofrecen dos tamaños de sistemas, configurables de 2+2 o 3+3 donde se incluyen 1 o 2 powers dependiendo de la elección + 1 USB de carga y los restantes son configurables, pudiendo incluir MiniJack, VGA, HDMI, USB de datos o RJ45.



PS0711

PS0721

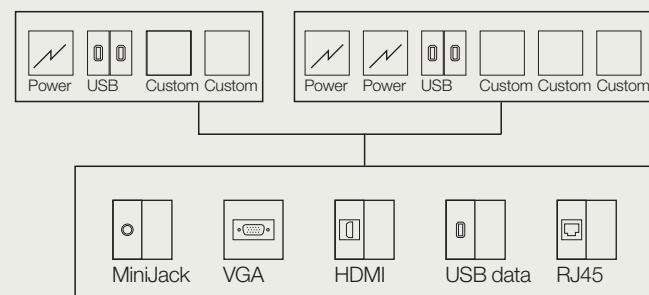

In surface
En superficie



Surface connection system

Composed of an interior cover with an exterior frame, both in anodized finish. Its opening is made by a soft touch. Two system sizes are available, configurable from 2 + 2 or 3 + 3 where 2 or 3 power ports are included depending on the choice and the rest are configurable, and may include MiniJack, VGA, HDMI, USB data ports or RJ45.

Sistema de conexiones integrado

Compuesto por una tapa interior y un marco exterior, ambos en acabado anodizado. Su apertura se realiza con una suave pulsación. Se ofrecen 2 tamaños de sistemas, configurables 2+2 o 3+3 donde se incluyen 2 o 3 powers dependiendo de la elección, y los restantes son configurables, pudiendo incluir MiniJack, VGA, HDMI, USB de datos o RJ 45.



PS0752

PS0753

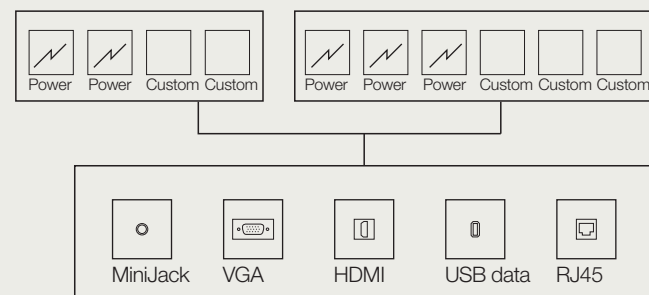

Wire management / Conectividad

America

Under top
Bajo sobre



Under table top connection system

Composed of a profile, in two finishes, black or white. Several sizes and configurations are available depending on the needs, 2 + 2 or 3 + 3, where 1 or 2 powers + 1 USB double charging are included, or if USB charging is not required 2 or 3 powers, and the rest are configurable being able to include miniJack and USB, VGA, HDMI and USB, 2 USB data or 2 RJ45. There is also a 1 + 1 version for small tables consisting of 1 power and the remaining configurable with miniJack and USB, VGA, HDMI and USB, 2 USB data, 2 RJ45 or 2 USB charging.

Sistema de conexiones bajo el sobre

Compuesto por un perfil, en dos acabados, negro o blanco. Se ofrecen varios tamaños y configuraciones dependiendo de las necesidades, 2+2 o 3+3, donde se incluyen 1 o 2 powers + 1 USB de carga doble, o si no se requiere USB de carga 2 o 3 powers, y los restantes son configurables pudiendo incluir miniJack y USB, VGA, HDMI and USB, 2 USB de datos o 2 RJ45. También hay una versión de 1+1 para mesas pequeñas compuesto por 1 power y el restante configurable con miniJack y USB, VGA, HDMI and USB, 2 USB de datos, 2 RJ45 o 2 USB de carga.



PS0755

PS0756

PS0750

PS0751

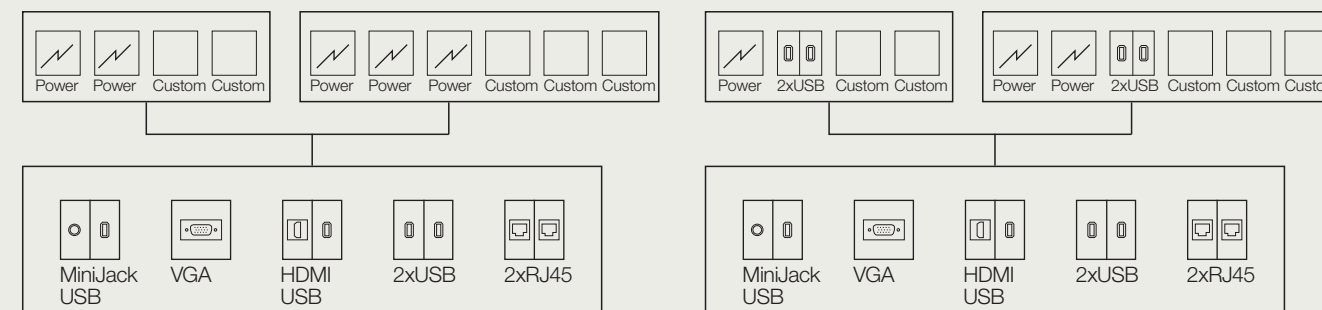

Wire management / Conectividad

In surface
En superficie**Integrated connection system**

Composed of 2 powers and 2 USB charging. The system turns on itself and remains hidden when it is not in use. It is available in two finishes, black and white.

Sistema de conexiones integrado

Compuesto por 2 powers y 2 USB de carga. El sistema gira sobre si mismo y permanecer oculto cuando no este en uso. Está disponible en dos acabados, negro y blanco.

PS0713

In surface
En superficie**Qi charging system**

Composed of a large surface for charging by induction, 1 power + 1USB charging (PS 0716) or 2USB charging (PS 0717). It is available in two finishes, black and white.

Sistema de carga Qi

Compuesto por una amplia superficie para cargar por inducción , 1 power+ 1USB de carga (PS 0716) o 2 USB de carga (PS 0717). Está disponible en dos acabados, negro y blanco.

PS0716 / PS0717



America

Wire management / Conectividad

In surface
En superficie**USB charging system**

Composed of 2 USB charging. It is available in two finishes, black and white.

Sistema de carga USB

Compuesto por 2 USB de carga. Está disponible en dos acabados, negro y blanco.

PS0718

In surface
En superficie**Qi charging system**

Composed of a large surface for charging by induction,. It is available in two finishes, black and white.

Sistema de carga Qi

Compuesto por una amplia superficie para cargar por inducción. Está disponible en dos acabados, negro y blanco.



Sistema SP

America

In surface
En superficie**Under table top USB charging system**

Composed of 2 USB charging, black or white.

Sistema de USB de carga bajo el sobre

Compuesto por 2 USB de carga . Está disponible en dos acabados, negro y blanco.

PS0715



Wire management / Conectividad

**Distribution
Distribución**

- 1. System distribution:** As standard, the connection system will be located in the center of the table. For tables with more than one system, these will be placed with a separation of 1/3 of the total length of the table and in the longitudinal direction.
- 2. Wire management:** The cable leaves the power system and passes through a snake.
- 3. Wire outlet:** The cable exits directly from the connection system through a snake that permits the changing of the final position of the wiring until it reaches the ground.

- 1. Distribución de sistemas:** De serie, el sistema de conexiones se dispondrá en el centro de la mesa. Para las mesas con más de un sistema, estos se colocarán con una separación de 1/3 de la longitud total de la mesa y en sentido longitudinal.
- 2. Gestión del cableado:** El cable sale del sistema de electrificación y pasa a través de un snake.
- 3. Salida del cableado:** La salida del cable se realiza directamente desde el propio sistema de conexiones a través de un snake que permite cambiar la posición final del cableado hasta llegar al suelo.

PS0710
PS0720

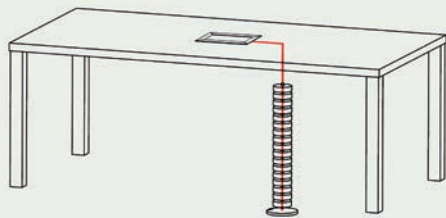
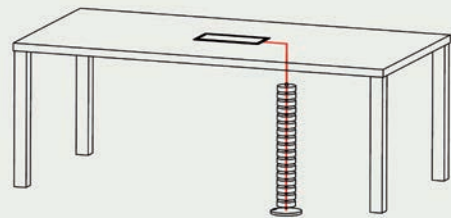

PS0784
PS0785

PS0787
PS0788

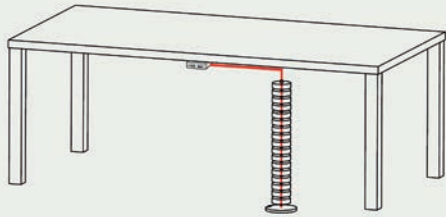
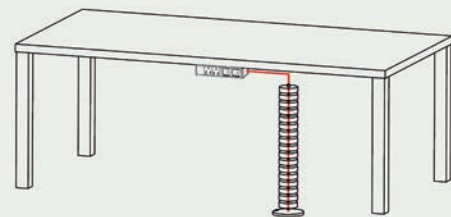

PS0715

PS0789
PS0790

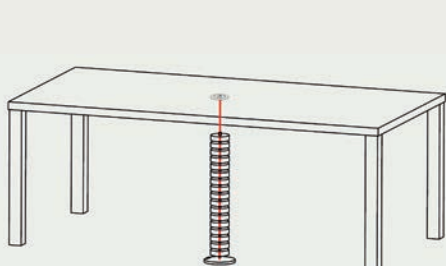
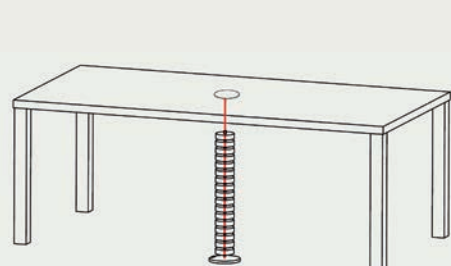

PS0718

Europe / RoW

Wire management / Conectividad

**In surface
En superficie**



Integrated connection system

Composed of an interior cover with the same finish as the table top, and exterior frame in matt black finish. Its opening is made on both sides. Two system sizes are available, configurable from 2 + 2 or 3 + 3 where 1 or 2 power ports are included depending on the choice + 1 USB charging port and the rest are configurable, and may include Minijack, VGA, HDMI, USB data ports or RJ45.

Sistema de conexiones integrado

Compuesto por una tapa interior con el mismo acabado que el sobre y un marco exterior de acabado negro mate. Su apertura se realiza en ambos lados. Se ofrecen dos tamaños de sistemas, configurables de 2+2 o 3+3 donde se incluyen 1 o 2 powers dependiendo de la elección + 1 USB de carga y los restantes son configurables, pudiendo incluir Minijack, VGA, HDMI, USB de datos o RJ45.



PS0710

PS0720

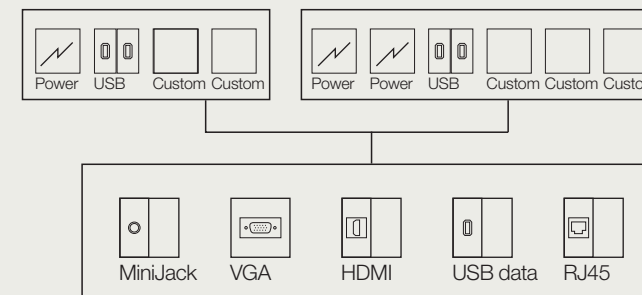

**In surface
En superficie**



Integrated connection system

Composed of an interior cover with an exterior frame, both in anodized finish. Its opening is made by a soft touch. Two system sizes are available, configurable from 2 + 2 or 3 + 3 where 1 or 2 power ports are included depending on the choice + 1 USB charging port and the rest are configurable, and may include Minijack, VGA, HDMI, USB data ports or RJ45.

Sistema de conexiones en superficie

Compuesto por una tapa interior y un marco exterior, ambos en acabado anodizado. Su apertura se realiza con una suave pulsación. Se ofrecen 2 tamaños de sistemas, configurables 2+2 o 3+3 donde se incluyen 2 o 3 powers dependiendo de la elección, y los restantes son configurables, pudiendo incluir Minijack, VGA, HDMI, USB de datos o RJ 45.



PS0784

PS0785

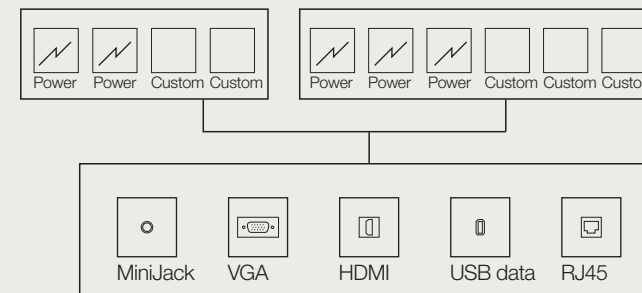

Wire management / Conectividad

Europe / RoW

Under top
Bajo sobre



Under table top connection system

Composed of a profile, in two finishes, black or white. Several sizes and configurations are available depending on the needs, 2 + 2 or 3 + 3, where 1 or 2 powers + 1 USB double charging are included, or if USB charging is not required 2 or 3 powers, and the rest are configurable being able to include minijack and USB, VGA, HDMI and USB, 2 USB data or 2 RJ45. There is also a 1 + 1 version for small tables consisting of 1 power and the remaining configurable with minijack and USB, VGA, HDMI and USB, 2 USB data, 2 RJ45 or 2 USB charging.

Sistema de conexiones bajo el sobre

Compuesto por un perfil, en dos acabados, negro o blanco. Se ofrecen varios tamaños y configuraciones dependiendo de las necesidades, 2+2 o 3+3, donde se incluyen 1 o 2 powers + 1 USB de carga doble, o si no se requiere USB de carga 2 o 3 powers, y los restantes son configurables pudiendo incluir minijack y USB, VGA, HDMI and USB, 2 USB de datos o 2 RJ45. También hay una versión de 1+1 para mesas pequeñas compuesto por 1 power y el restante configurable con minijack y USB, VGA, HDMI and USB, 2 USB de datos, 2 RJ45 o 2 USB de carga.



PS0787

PS0788

PS0789

PS0790

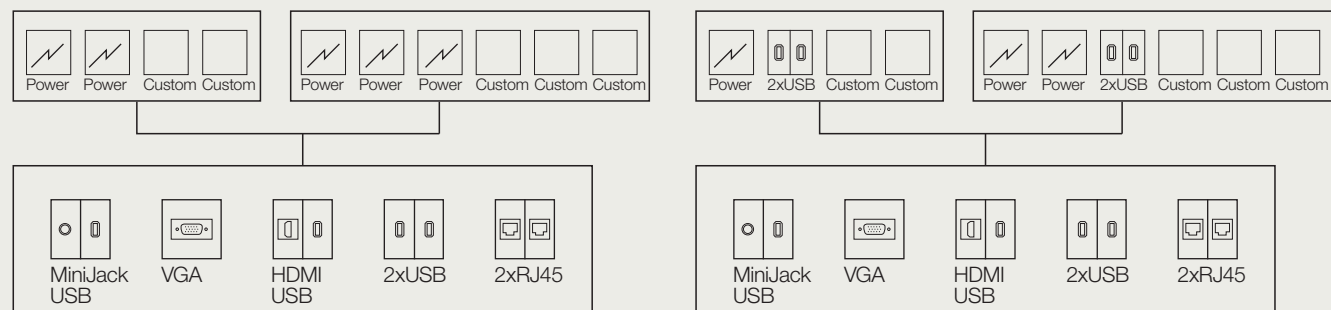

Wire management / Conectividad

Europe / RoW

In surface
En superficie



Under table top USB charging system

Composed of 2 USB charging, black or white.

Sistema de USB de carga bajo el sobre

Compuesto por 2 USB de carga. Está disponible en dos acabados, negro y blanco.

PS0715



In surface
En superficie



Qi charging system

Composed of a large surface for charging by induction. It is available in two finishes, black and white.

Sistema de carga Qi

Compuesto por una amplia superficie para cargar por inducción. Está disponible en dos acabados, negro y blanco.

PS0714



In surface
En superficie



USB charging system

Composed of 2 USB charging. It is available in two finishes, black and white.

Sistema de carga USB

Compuesto por 2 USB de carga. Está disponible en dos acabados, negro y blanco.

PS0718



Status is a series of meeting tables of marked technological character that are characterized by broad flexibility and adaptability through different types of bases and table tops. Its design starts from an iconic and sculptural central base, which generates a volumetric presence and gives it a differentiated design through a neutral aesthetic with rounded and smooth lines that stand out for their architectural gesture.

Status

by Estudio Andreu

Status es un programa de mesas de reunión de marcado carácter tecnológico que se caracteriza por una amplia flexibilidad y adaptabilidad a través de diferentes tipos de bases y sobres. Su diseño parte de una base central icónica y escultural, que genera una presencia volumétrica y le dota de un diseño diferenciado a través de una estética neutra con líneas redondeadas y suaves que destacan por su gesto arquitectónico.



Conference room
Sala de reuniones
▼ ME02127/ SO1496
Table with polyethylene
four bases and laminate top.
Mesa de cuatro bases de
polietileno y sobre laminado.



Conference room

Sala de reuniones

▼ ME02070 / SO1473

Table with three polyethylene

bases y sobre de roble.

Mesa de tres bases de

polietileno and oak top.



Tops / Sobres

Wooden board tops of different shapes and sizes, available in oak finish, lacquered, laminate, HPL, Technical stone 8, and glass. Connection box available. Registrable door available.

Sobres de tablero de diferentes formas y medidas, disponibles en acabado roble, lacado, laminado, laminado TP, Technical stone 8 y cristal. Disponible caja de conexiones. Disponible caja de registro.

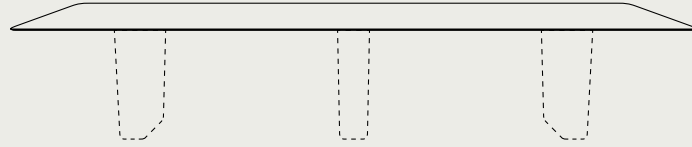

Oak Roble



306 307 378 322 336 364 372 369 381 304 318 320

Premium finishes and wood lacquers Acabados premium y lacados



610 641 645L Sand Arena 605L NCS S 6502-B Dark grey Gris oscuro 380 661 Red Rojo 642L Cayenne red Rojo cayena 606L RAL 1005 Yellow mustard Amarillo mostaza

Laminate / Laminado TP Laminado / Laminado TP



L205 Oak Roble L204 Maple Arce L203 Cherry Cerezo L202 Walnut Nogal L206 Dark walnut Nogal oscuro L200 White Blanco L201 Black Negro L300 Sand Arena L302 Basalt grey Gris basalto L301 Dark grey Gris oscuro

Glass Cristal



White Blanco Sand Arena Basalt grey Gris basalto Cayenne red Rojo cayena Dark grey Gris oscuro Matte black Negro mate

Technical stone 8

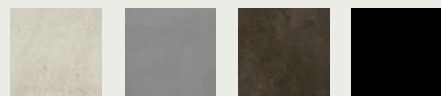

DKAR Sand Arena DKRC Rock grey Gris roca DKMR Earth brown Marrón tierra DKNG Black Negro

Marble top Sobres marmol

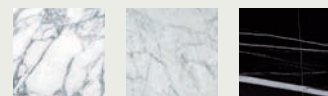

Calacatta Carrara Bamboo Bambú

Tops / Sobres

Top 30 Razor

30mm./1.18in. thick table top and bevelled edge. Sobre de mesa de 30mm./1.18in. de espesor y con canto biselado.

Oak / Roble - Technical stone 8 Laminated / Laminado Lacquered / Lacado Linoleum / Linóleo Ultra-matte / Ultramate Cement / Cemento



Top 30 Razor TP

30mm./1.18in. thick table top and matching thermopolymer bevelled edge. Sobre de mesa de 30mm./1.18in. de espesor y con canto de termopolimero a juego.

Laminated TP / Laminado TP Ultra-matte TP / Ultramate TP



Top Glass 35

36mm./1.4in. thick table top, with 6mm./0.2in. tempered glass + 30mm./1.2in. substrate. Sobre de mesa de 36mm./1.4in. de espesor, con cubierta de cristal templado de 6mm./0.2in. + sustrato de 30mm./1.2in.



Top 20 Marble Square

20mm./0.80in. marble table top. Sobre de mesa de mármol de 20mm/0.80in. de espesor

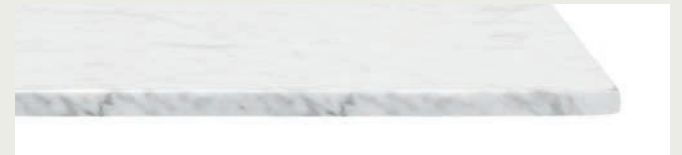

Legs / Pies

Table program in different base types and table tops. Central polyethylene bases available in various colors.

Programa de mesas disponibles con diferentes tipos de bases y sobres de mesa. Bases centrales de polietileno disponible en varios colores.

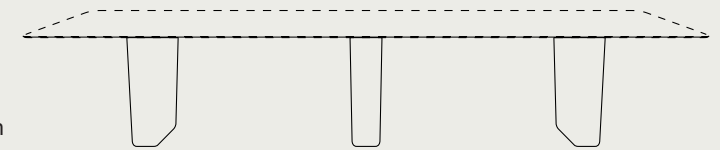

Polyethylene Polietileno



6000 RAL White Blanco 6006 RAL 9005 Black Negro

Meeting tables / Mesas de reunión

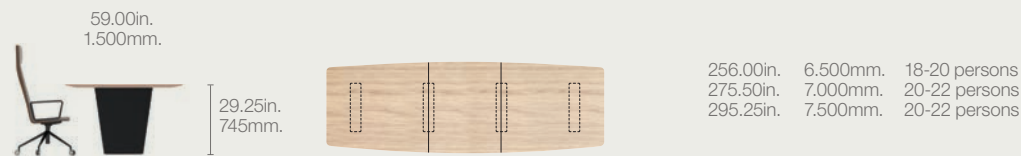
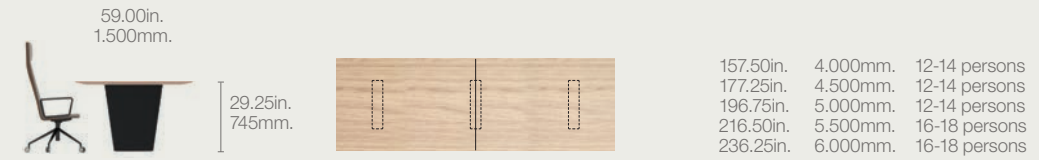
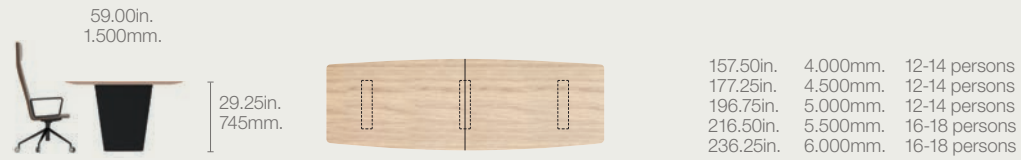

Wire management / Conectividad

America

**Distribution
Distribución**

1. Power boxes distribution: By standard, the power/data box would be offset relative to the base. For tables with more than one power box, these will be separated 1/3 between them and placed horizontally and longitudinally.

2. Wire management: The cable passes through an aluminum wire manager, keeping it hidden from the users.

3. Wiring exit: the cable exits directly from the power system or through an aluminum frame so that it is concealed at the bottom of the base. The cable then crosses the aluminum profiles of the legs and is completely hidden until it reaches the floor.

1. Distribución de sistemas: De serie, el sistema de conexiones se dispondrá en el centro de la mesa. Para las mesas con más de un sistema, estos se colocarán con una separación de 1/3 de la longitud total de la mesa y en sentido longitudinal.

2. Gestión del cableado: El cable sale del sistema de electrificación, pasa a través del perfil de aluminio lateral y baja por la pata.

3. Salida del cableado: La salida del cable se realiza directamente desde el propio sistema de conexiones a través del perfil de aluminio lateral, que oculta el cableado y baja por el interior de la pata hasta llegar al suelo.

PS0711
PS0721

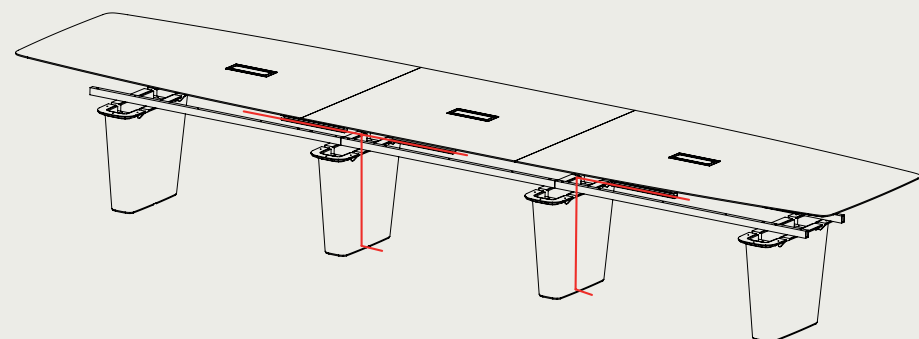
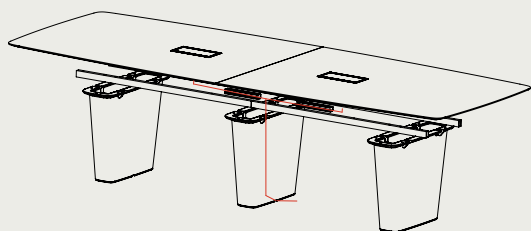

PS0752
PS0753

PS0718

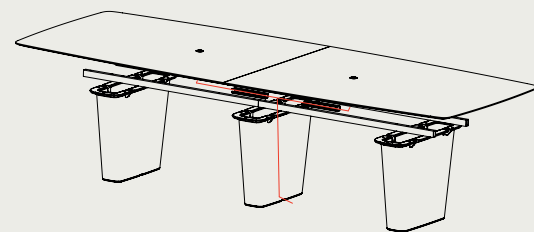

PS0715

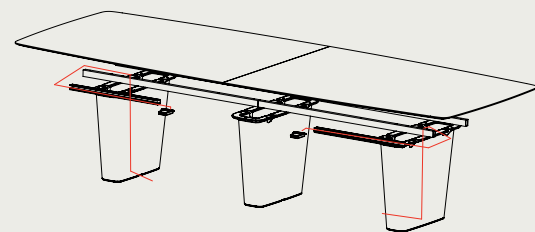

Wire management / Conectividad

Europe / RoW

PS Top-Tech

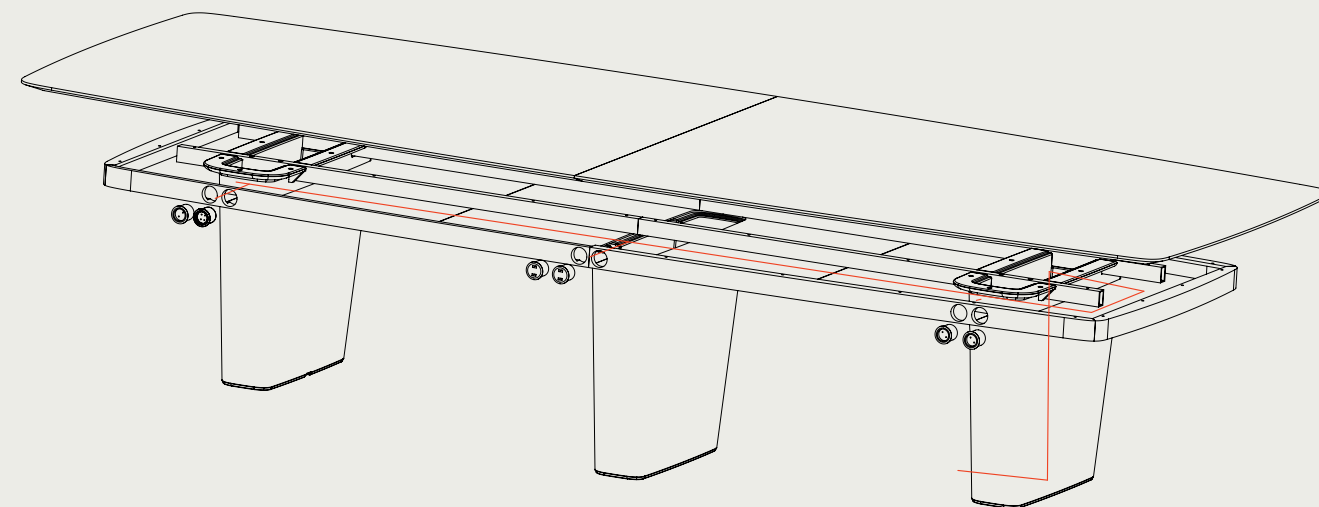

220 - 350 (4 power + 4 USB charger)

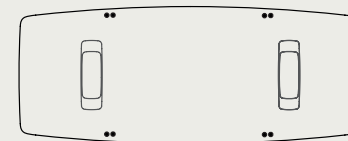

400 - 500 (6 power + 6 USB charger)

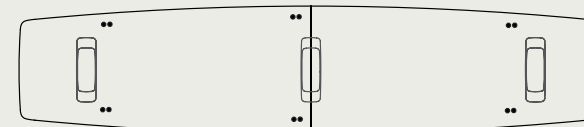

550 - 750 (8 power + 8 USB charger)

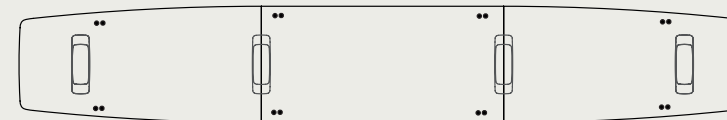

Wire management / Conectividad

America

In surface
En superficie 

Integrated connection system

Composed of an interior cover with the same finish as the table top, and exterior frame in matt black finish. Its opening is made on both sides.
Two system sizes are available, configurable from 2 + 2 or 3 + 3 where 1 or 2 power ports are included depending on the choice + 1 USB charging port and the rest are configurable, and may include MiniJack, VGA, HDMI, USB data ports or RJ45.

Sistema de conexiones integrado

Compuesto por una tapa interior con el mismo acabado que el sobre y un marco exterior de acabado negro mate. Su apertura se realiza en ambos lados. Se ofrecen dos tamaños de sistemas, configurables de 2+2 o 3+3 donde se incluyen 1 o 2 powers dependiendo de la elección + 1 USB de carga y los restantes son configurables, pudiendo incluir MiniJack, VGA, HDMI, USB de datos o RJ45.

PS0711

PS0721

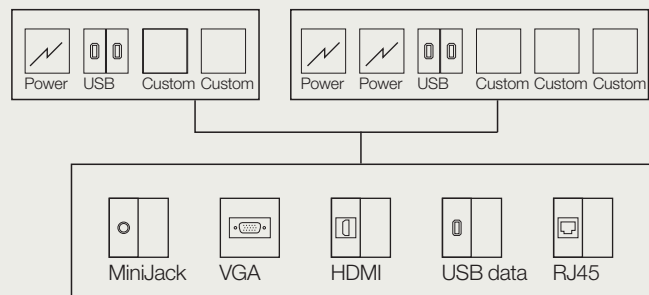

In surface
En superficie 

Surface connection system

Composed of an interior cover with an exterior frame, both in anodized finish. Its opening is made by a soft touch. Two system sizes are available, configurable from 2 + 2 or 3 + 3 where 2 or 3 power ports are included depending on the choice and the rest are configurable, and may include MiniJack, VGA, HDMI, USB data ports or RJ45

Sistema de conexiones en superficie

Compuesto por una tapa interior y un marco exterior, ambos en acabado anodizado. Su apertura se realiza con una suave pulsación. Se ofrecen 2 tamaños de sistemas, configurables 2+2 o 3+3 donde se incluyen 2 o 3 powers dependiendo de la elección, y los restantes son configurables, pudiendo incluir MiniJack, VGA, HDMI, USB de datos o RJ 45.

PS0752

PS0753

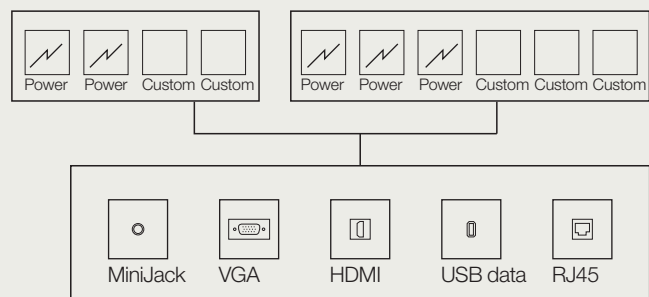

Wire management / Conectividad

America

In surface
En superficie 

USB charging system

Composed of 2 USB charging. It is available in two finishes, black and white.

Sistema de carga USB

Compuesto por 2 USB de carga. Está disponible en dos acabados, negro y blanco.

PS0718



Under top
Bajo sobre 

Under table top USB charging system

Composed of 2 USB charging, black or white. It is available in two finishes, black and white.

Sistema de USB de carga bajo el sobre

Compuesto por 2 USB de carga. Está disponible en dos acabados, negro y blanco.

PS0715



Wire management / Conectividad

Europe / RoW

**Distribution
Distribución**

- 1. Power boxes distribution:** By standard, the power/data box would be offset relative to the base. For tables with more than one power box, these will be separated 1/3 between them and placed horizontally and longitudinally.
- 2. Wire management:** The cable passes through an aluminum wire manager, keeping it hidden from the users.
- 3. Wiring exit:** the cable exits directly from the power system or through an aluminum frame so that it is concealed at the bottom of the base. The cable then crosses the aluminum profiles of the legs and is completely hidden until it reaches the floor.

- 1. Distribución de sistemas:** De serie, el sistema de conexiones se dispondrá en el centro de la mesa. Para las mesas con más de un sistema, estos se colocarán con una separación de 1/3 de la longitud total de la mesa y en sentido longitudinal.
- 2. Gestión del cableado:** El cable sale del sistema de electrificación, pasa a través del perfil de aluminio lateral y baja por la pata.
- 3. Salida del cableado:** La salida del cable se realiza directamente desde el propio sistema de conexiones a través del perfil de aluminio lateral, que oculta el cableado y baja por el interior de la pata hasta llegar al suelo.

PS0710
PS0720

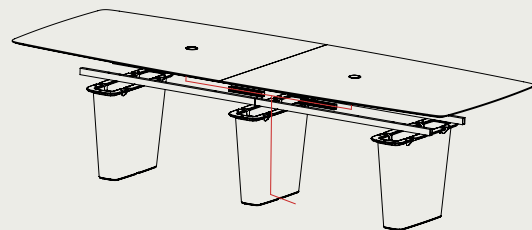
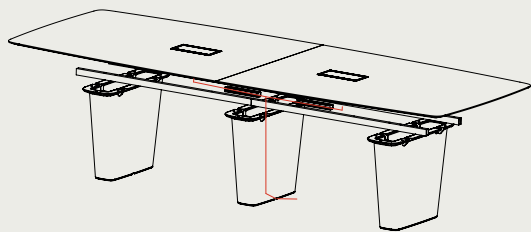

PS0715

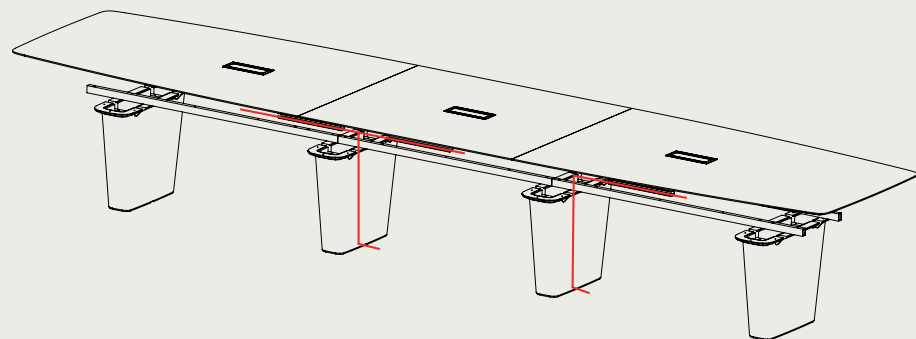

PS0784
PS0785

PS0718

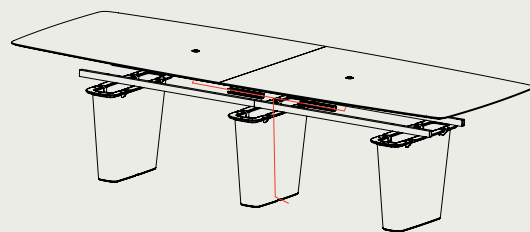

PS0715

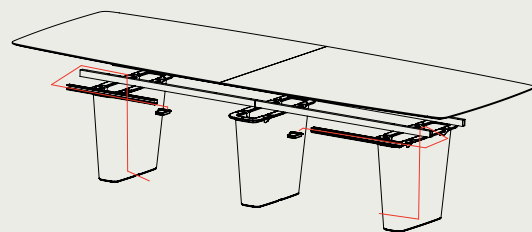

Wire management / Conectividad

Europe / RoW

PS Top-Tech

Top-Tech power box
Double USB charge
Power socket

Sistema eléctrico Top-Tech
Doble USB de carga
Toma de alimentación

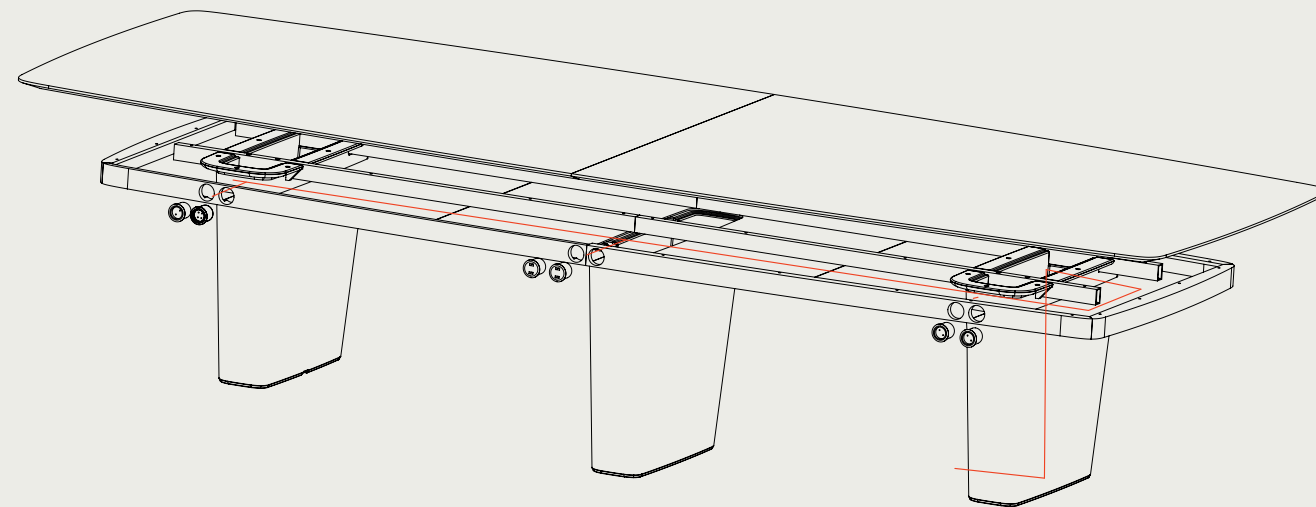

220 - 350 (4 power + 4 USB charger)

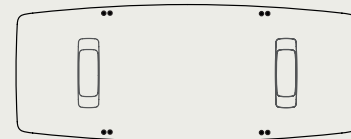

400 - 500 (6 power + 6 USB charger)

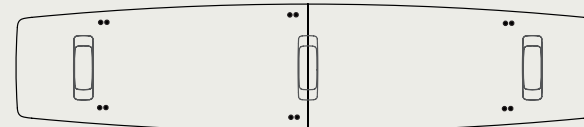

550 - 750 (8 power + 8 USB charger)



Wire management / Conectividad

Europe / RoW

In surface
En superficie 

Integrated connection system

Composed of an interior cover with the same finish as the table top, and exterior frame in matt black finish. Its opening is made on both sides. Two system sizes are available, configurable from 2 + 2 or 3 + 3 where 1 or 2 power ports are included depending on the choice + 1 USB charging port and the rest are configurable, and may include MiniJack, VGA, HDMI, USB data ports or RJ45.

Sistema de conexiones integrado

Compuesto por una tapa interior con el mismo acabado que el sobre y un marco exterior de acabado negro mate. Su apertura se realiza en ambos lados. Se ofrecen dos tamaños de sistemas, configurables de 2+2 o 3+3 donde se incluyen 1 o 2 powers dependiendo de la elección + 1 USB de carga y los restantes son configurables, pudiendo incluir MiniJack, VGA, HDMI, USB de datos o RJ45.



PS0710

PS0720

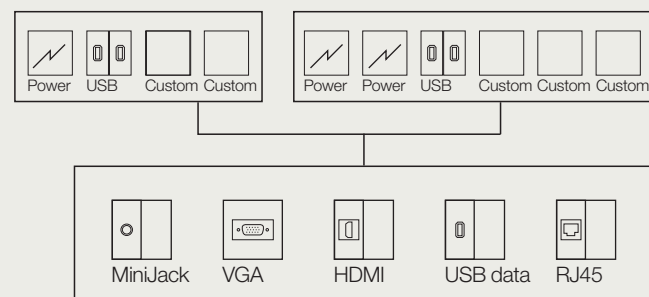

In surface
En superficie 

Surface connection system

Composed of an interior cover with an exterior frame, both in anodized finish. Its opening is made by a soft touch. Two system sizes are available, configurable from 2 + 2 or 3 + 3 where 2 or 3 power ports are included depending on the choice and the rest are configurable, and may include MiniJack, VGA, HDMI, USB data ports or RJ45.

Sistema de conexiones en superficie

Compuesto por una tapa interior y un marco exterior, ambos en acabado anodizado. Su apertura se realiza con una suave pulsación. Se ofrecen 2 tamaños de sistemas, configurables 2+2 o 3+3 donde se incluyen 2 o 3 powers dependiendo de la elección, y los restantes son configurables, pudiendo incluir MiniJack, VGA, HDMI, USB de datos o RJ 45.



PS0784

PS0785

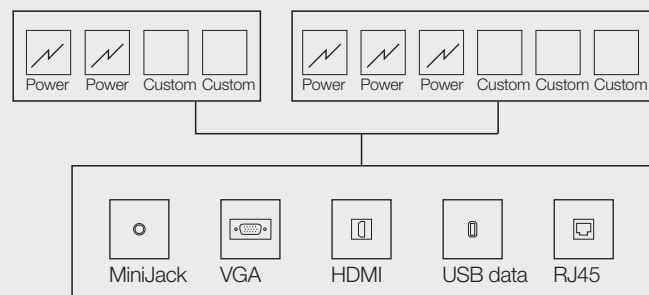

Wire management / Conectividad

Europe / RoW

Under top
Bajo sobre 

Under table top USB charging system

Composed of 2 USB charging, black or white. It is available in two finishes, black and white

Sistema de USB de carga bajo el sobre

Compuesto por 2 USB de carga. Está disponible en dos acabados, negro y blanco.

PS0715



In surface
En superficie 

Qi charging system

Composed of a large surface for charging by induction, It is available in two finishes, black and white.

Sistema de carga Qi

Compuesto por una amplia superficie para cargar por inducción. Está disponible en dos acabados, negro y blanco.

In surface
En superficie 

Qi charging system

Composed of 2 USB charging. It is available in two finishes, black and white.

Sistema de carga Qi

Compuesto por una amplia superficie para cargar por inducción. Está disponible en dos acabados, negro y blanco.

PS0718



PS0714



The Nuez Table collection starts from the formal aspect of the Nuez seating collection. They are developed from pyramidal bases with 3 or 4 ash wood legs, in different heights. Its round table tops cover a wide range of diameters. Its wide variety of measures and finishes makes the Nuez Table extremely versatile, suitable for all types of projects and uses, in workspaces, waiting areas or lobbies, and also at home.

Nuez Table

by Patricia Urquiola



La colección Nuez Table parte del aspecto formal de la colección de asientos Nuez. Están desarrolladas a partir de bases piramidales de 3 o 4 patas de madera de fresno, en diferentes alturas. Sus sobres redondos abarcan un amplio rango de diámetro. Su gran variedad de medidas y acabados convierte a las Nuez Table en extremadamente versátiles, adecuadas para todo tipo de proyectos y usos, en espacios de trabajo, zonas de espera o lobbies, y también en el hogar.



Coffe office

► **ME2825/ BQ2781**

High table with oak top and ash legs.

Mesa alta con sobre de roble y pies de fresno.

▼ **ME2863**

Table with central base in oak wood and lacquered top.

Mesa con base central de madera de fresno y sobre de lacado.

Conference room

Sala de reunión

► **ME2860/ SI2786**

Table with central base in ash wood and oak top.

Mesa con base central de madera de fresno y sobre de roble.



Tops / Sobres

Table tops in oak wood, lacquered wood, laminate wood, ultramatte, linoleum or Compacto HPL. Round table tops only version, in different sizes. Available in 2 heights.

Sobres de mesa en diferentes acabados madera de roble, madera lacada, madera laminada, ultramate, linóleo o Compacto HPL. Sobres de mesa sólo redondos, en varias medidas. Disponible en 2 alturas.

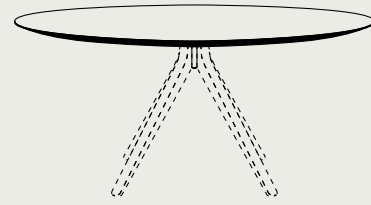

Oak Roble

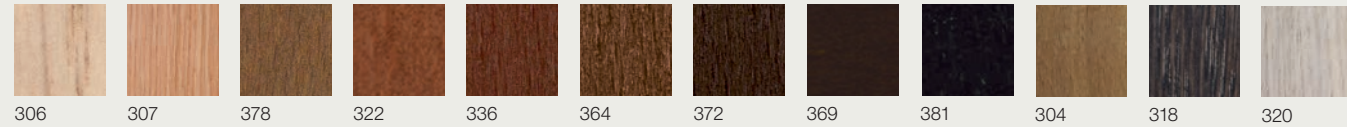

Premium finishes and wood lacquers Acabados premium y lacados

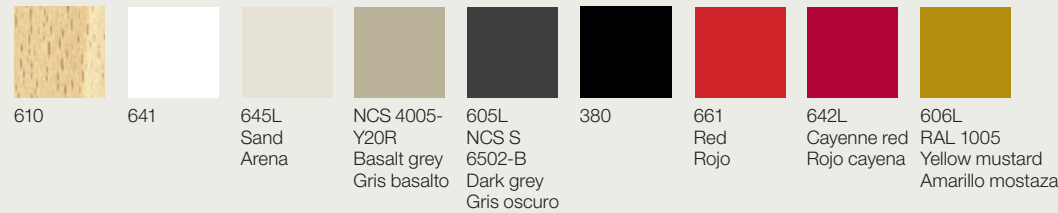

Laminate / Laminado TP Laminado / Laminado TP

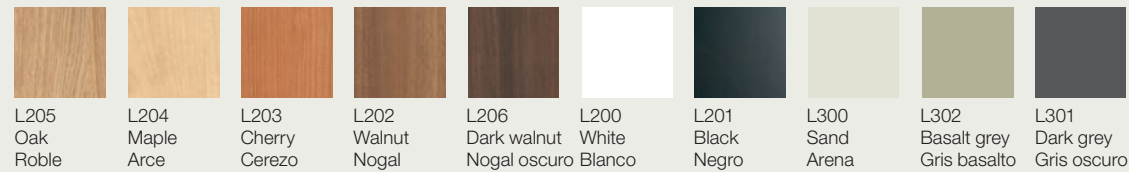

Compacto HPL

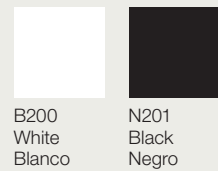

Linoleum Linóleo

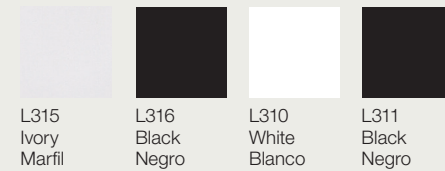

Ultra-matte Ultramate

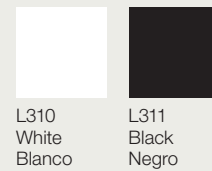

Top 18

18 mm./0.75in. thick table top with bevelled edge. Sobre de mesa de 18mm./0.75in. de espesor con canto biselado.

Oak / Roble
Laminated / Laminado
Lacquered / Lacado
Linoleum / Linóleo
Ultra-matte / Ultramate



Tops / Sobres

Top Compacto HPL

12mm/0.50in. thick table top, composed of a compact center high pressure laminate (HPL). Sobre de mesa de 12mm/0.50in. de espesor, compuesto por un laminado de alta presión de centro compacto (HPL)



Legs / Pies

Table program with central base in ash wood.

Programa de mesas disponible con base central en madera de fresno.

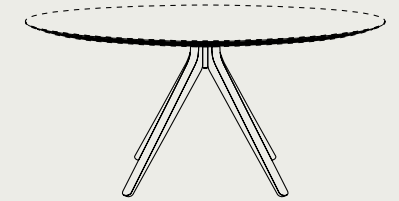

Ash Fresno

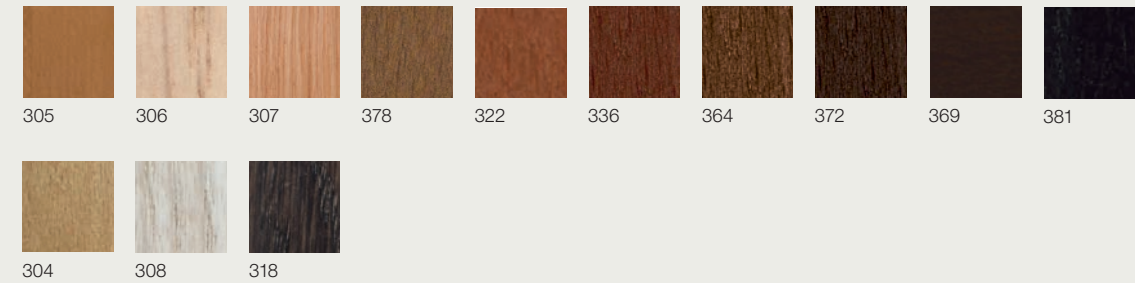

Tables / Mesas

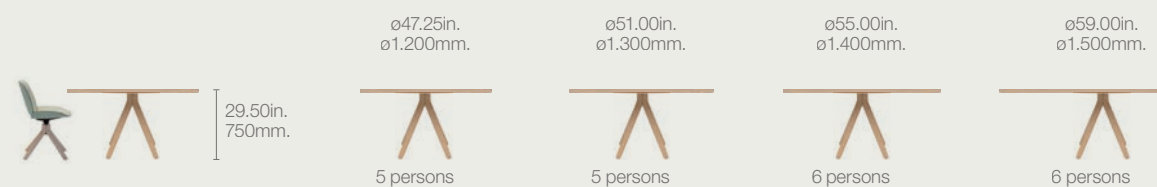

Tao is a powerful symbol that can attract all the attention and impose its personality on a space. Made in oak wood, Tao is sculptural piece that combines simplicity and uniqueness.

Tao es un signo poderoso capaz de capturar todas las miradas y de imponer su personalidad en un espacio. Realizada en madera de roble, Tao es escultural y propone una forma única que aúna sobriedad y singularidad.

Tao

by Lievore Altherr Molina



▼ ME3111 / SI1314

Table with oak top and base
in solid oak wood.

Mesa con sobre de roble y
base de madera maciza de
roble.

▼ ME3111



Home office

▼ ME3110 / SO2997

Table with oak top and base
in solid oak wood.

Mesa con sobre de roble y
base de madera maciza de
roble.



Meeting tables / Mesas de reunión

Tables with oak table top and base in solid oak wood.

Mesas con sobres de roble y base de madera maciza de roble.

Oak Roble



306 307 378 322 336 364 372 369 381 304 318 320

Premium finishes and wood lacquers Acabados premium y lacados



610 641 645L Sand Arena NCS 4005-Y20R Basalt grey Gris basalto 605L NCS S 6502-B Dark grey Gris oscuro 380 661 Red Rojo 642L Cayenne red Rojo cayena 606L RAL 1005 Yellow mustard Amarillo mostaza

Meeting tables / Mesas de reunión



It expresses the nobility and sturdiness of wood in a clear, contemporary language. It adapts to all kinds of residential or business environments and easily blends in with all of our chair collections.

Expresa la nobleza y la rotundidad de la madera con un lenguaje claro y contemporáneo. Se adapta a todo tipo de ambientes, residenciales o de contract, y armoniza sin problemas con todas nuestras colecciones de sillas.

Uves

by Lievore Altherr Molina



Conference room
Sala de reunión
▼ ME3665 / SO7020
Table with oak top and
base in solid oak wood.
Mesa con sobre de roble
y base de madera maciza
de roble.



Residential

Hogar

► **ME3664** / SO4200

Table with oak top and base in solid oak wood.
Mesa con sobre de roble y base de madera maciza de roble.

▼ **ME3664**

Table with oak top and base in solid oak wood.
Mesa con sobre de roble y base de madera maciza de roble.

Residential

Hogar

► **ME3661** / SO4200

Table with oak top and base in solid oak wood.
Mesa con sobre de roble y base de madera maciza de roble.



Meeting tables / Mesas de reunión

Tables with oak table top and base in solid oak wood.

Mesas con sobres de roble y base de madera maciza de roble.

Oak Roble

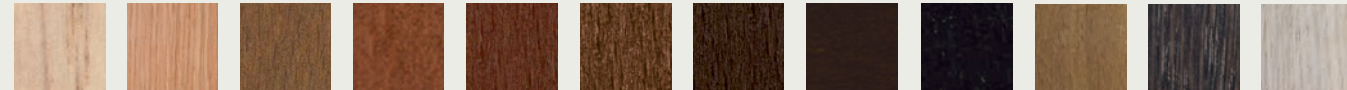

306 307 378 322 336 364 372 369 381 304 318 320

Premium finishes and wood lacquers Acabados premium y lacados

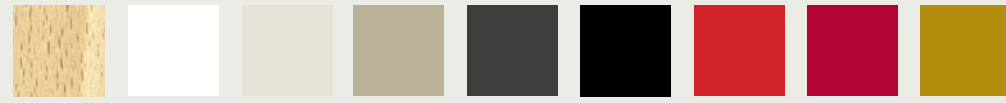

610 641 645L Sand Arena NCS 4005-Y20R Basalt grey Gris basalto 605L NCS S 6502-B Dark grey Gris oscuro 380 661 Red Rojo 642L Cayenne red Rojo cayena 606L RAL 1005 Yellow mustard Amarillo mostaza

Meeting tables / Mesas de reunión

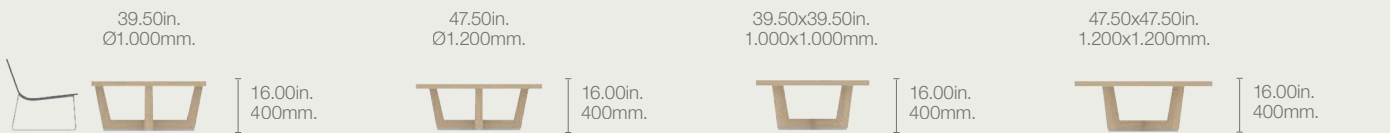
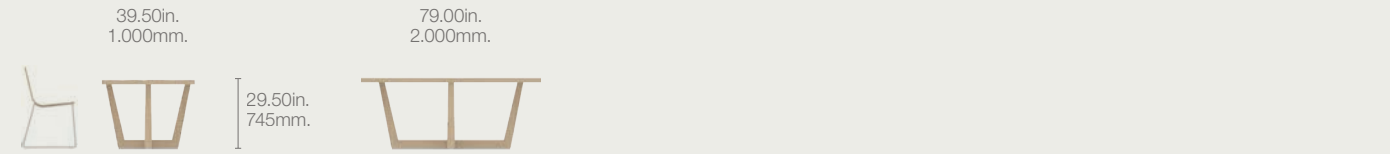
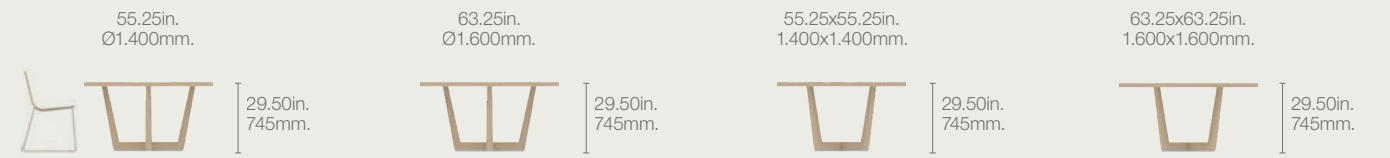

The Colors bases can be used with any model from the Top collection, allowing to create very stable and versatile tables. Both the foot and column are made from steel, with 3 different heights and suitable for either indoor or outdoor.

Las bases Colors, en combinación con cualquier modelo de la colección Top, permiten el desarrollo de mesas de gran estabilidad y versatilidad. Tanto el pie como la columna están realizados en acero, en tres alturas diferentes y pueden utilizarse en interiores o exteriores, indistintamente.

Colors

by Estudio Andreu





Cafeteria
Cafetería
▼ **BM4552 + SB7229** / SI0906
Steel central base and
lacquered top.
Base central de acero y
sobre lacado.

Cafeteria
Cafetería
► **BM4550 + SB7145** / SI0905
Steel central base and
maple top.
Base central de acero y
sobre de arce.



Cafeteria

Cafetería

► **BM4552 + SB4472**

Steel central base and lacquered top.
Base central de acero y sobre lacado.

▼ **BM4552 + SB4467**

Steel central base and lacquered top.
Base central de acero y sobre lacado.

▼ **BM4550 + SB4470**

Steel central base and lacquered top.
Base central de acero y sobre lacado.



Base

Table base with steel squared column and plate. Available in different colors. It can be combined with all Top collection models.

Base de mesa con pie y columna de acero. Disponible en diferentes colores. Combinable con cualquier modelo de la colección Top.

**Steel
Acero**



White
Blanco

Sand
Arena

Basalt grey
Gris basalto

Dark grey
Gris oscuro

Black
Negro

Measurements / Medidas



Sobres de mesa / Table tops

Top 18

18 mm./0.75in. thick table top with bevelled edge.
Sobre de mesa de 18mm./0.75in. de espesor con canto biselado.

Finishes / acabados

Oak / Roble
Laminated / Laminado
Lacquered / Lacado
Linoleum / Linóleo
Ultra-matte / Ultramate

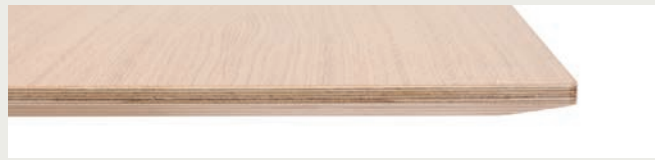

Top 23

23mm./1in. thick two face table top finished in a maple veneer.
Sobres de 23mm. chapados arce a dos caras.

Lacquered / Lacado
Maple / Arce
Linoleum / Linóleo
Ultra-matte / Ultramate



Top 30 Square

30mm./1.18in. thick laminated table top.
Sobre de mesa laminado de 30mm./1.18in. de espesor.

Oak / Roble
Laminated / Laminado
Laminated TP / Laminado TP
Lacquered / Lacado
Linoleum / Linóleo
Ultra-matte / Ultramate
Ultra-matte TP / Ultramate TP



Top Solid Surface

12mm./0.5in. thick solid surface table top. Available in Glacier White color. Suitable for outdoor use.
Sobre de mesa de 12mm./0.5in. de espesor con canto biselado. Disponible en color blanco glaciar. Adecuado para uso en exteriores.

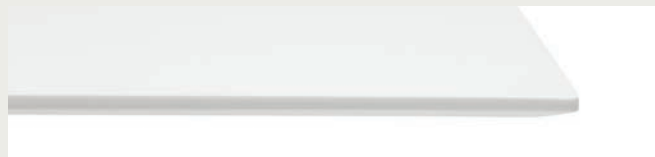

Sobres de mesa / Table tops

Top SP 40

Laminate table top, 40 mm / 1.18 in thickness and matching thermopolymer edge.
Sobre de mesa laminado de 40mm y con canto de termopolimero a juego.

Laminated / Laminado
Lacquered / Lacado
Linoleum / Linóleo
Ultra-matte / Ultramate

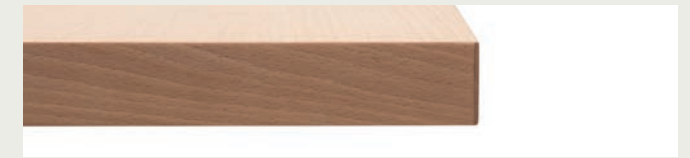

Top Glass 10

10mm./0.4in. thick tempered glass. Optical glass version available. Suitable for outdoor use. The total thickness of table top is 10mm. glass + 12mm./0.5in. compact HPL.
10mm./0.4in. Vidrio templado. Versión de cristal óptico disponible. Adecuado para uso en exteriores. El grosor total de la mesa es de 10 mm. vidrio + 12mm./0.5in. Compacto HPL.



Top Compacto HPL

12mm./0.5in. thick solid core high pressure laminate top (HPL). Suitable for outdoor and high traffic areas.
Sobre de mesa de 12mm./0.5in. de espesor, con cubierta laminada de alta presión y centro compacto (HPL). Adecuado para zonas exteriores y de alto tránsito.



Top Technical Stone

3mm./0.15in ceramic top + 5mm./0.2in glass board. Colors: brown earth, sand gray, stone gray. Valid for any central column collection. Suitable for outdoor use.
Tablero de mesa compuesto por una cubierta cerámica de 3mm./0.15in. + tablero de vidrio de 5mm./0.2in. Colores: Marrón tierra, Gris arena, Gris piedra. Válido para cualquier colección de columna central. Válido para su uso en exterior.



It is a lightweight, functional and svelte but very stable base. The oval column, available in two heights, and it's the round injected aluminum base distinguish the design from other bases. The Dual combines with any Top Collection top.

Es una base ligera, esbelta y funcional; siempre muy estable. Dual se diferencia por el rasgo ovalado de su columna, disponible en cuatro alturas, y por su base circular de aluminio inyectado. Combina con cualquier sobre de la colección Top.

Dual

by Lievore Altherr Molina





Dual



Waiting area
Zona de espera
◀ **BM3347 + SB3478 Dual 45 / BU0597**
Aluminum table base in white finish and laminated top.
Base de mesa de aluminio con acabado blanco y sobre laminado.

Restaurant
Restaurante
▼ **BM3342 + SB4463 Dual 45 / SI1248**
Aluminum table base in black finish and compact board top.
Base de mesa de aluminio con acabado negro y sobre compacto.

Dual

Waiting area
Zona de espera
▼ **BM3347 + SB4580** / BU4201

Occasional aluminum table in matte white finish and round compact top.
Mesa auxiliar de aluminio en acabado blanco mate y sobre redondo compacto.



Cafeteria
Cafetería
► **BM4392+ SB3480 Dual 50** / SI0374

Aluminum table base in white finish and laminated board top.
Base de mesa de aluminio con acabado blanco y sobre laminado.





▲ **BM4376 + SB3942 Dual 45**
 Aluminum table base in white finish and laminated top.

Base de mesa de aluminio con acabado blanco y sobre laminado.

▲ **BM3342 + SB3479 Dual 45**
 Aluminum table base in black finish and laminated top.

Base de mesa de aluminio con acabado negro y sobre laminado.

▲ **BM3340 + SB3468 Dual 45**
 Aluminum table base in polished aluminum finish and oak top.

Base de mesa de aluminio con acabado aluminio pulido y sobre de roble.

Restaurant
Restaurante

► **BM3342 + SB4463 Dual 45 / SI1248**
 Aluminum table base in black finish and lacquered top.

Base de mesa de aluminio con acabado negro y sobre lacado.

Meeting room
Sala de reuniones

► **BM4392 + SB4584 Dual 50 / SO1305**
 Aluminum table base in white finish and high pressure laminated top (HPL).

Base de mesa de aluminio con acabado blanco y sobre compacto laminado de alta presión (HPL).



Dual



Dual

211

**Restaurant
Restaurante**
▼ BM3356 + SB3515 Dual 60 / SI0653
Aluminum table base in white finish and
oak top.
Base de mesa de aluminio con acabado
blanco y sobre de roble.



Base

Injected aluminum table base with an oval column and rounded base plate. Available in 3 different diameters and 4 heights. Offered in polished aluminum, matte white or matte black. Combinable with any model from our Top collection.

Base de mesa con pie circular y columna ovalada de inyección de aluminio. Disponible en 3 diámetros y 4 alturas diferentes. Se ofrece en acabados aluminio pulido, blanco mate o negro mate. Combinable con cualquier modelo de la colección Top.

Aluminum Aluminio



Polished aluminum
Aluminio pulido

Matte white
Blanco mate

Matte black
Negro mate

Measurements / Medidas

Dual 45



Measurements / Medidas

Dual 50



Dual 60



Sobres de mesa / Table tops

Top 18

18 mm./0.75in. thick table top with bevelled edge.
Sobre de mesa de 18mm./0.75in. de espesor con canto biselado.

Finishes / acabados

Oak / Roble
Laminated / Laminado
Lacquered / Lacado
Linoleum / Linóleo
Ultra-matte / Ultramate



Top 23

23mm./1in. thick two face table top finished in a maple veneer.
Sobres de 23mm. chapados arce a dos caras.

Lacquered / Lacado
Maple / Arce
Linoleum / Linóleo
Ultra-matte / Ultramate



Top 30 Square

30mm./1.18in. thick laminated table top.
Sobre de mesa laminado de 30mm./1.18in. de espesor.

Oak / Roble
Laminated / Laminado
Laminated TP / Laminado TP
Lacquered / Lacado
Linoleum / Linóleo
Ultra-matte / Ultramate
Ultra-matte TP / Ultramate TP



Top Solid Surface

12mm./0.5in. thick solid surface table top. Available in Glacier White color. Suitable for outdoor use.
Sobre de mesa de 12mm./0.5in. de espesor con canto biselado. Disponible en color blanco glaciar. Adecuado para uso en exteriores.

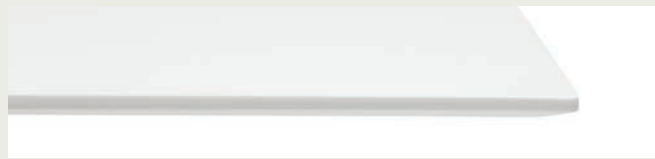

Sobres de mesa / Table tops

Top SP 40

Laminate table top, 40 mm / 1.18 in thickness and matching thermopolymer edge.
Sobre de mesa laminado de 40mm y con canto de termopolimero a juego.

Laminated / Laminado
Lacquered / Lacado
Linoleum / Linóleo
Ultra-matte / Ultramate

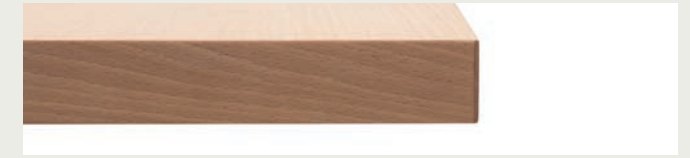

Top Glass 10

10mm./0.4in. thick tempered glass. Optical glass version available. Suitable for outdoor use. The total thickness of table top is 10mm. glass + 12mm./0.5in. compact HPL.
10mm./0.4in. Vidrio templado. Versión de cristal óptico disponible. Adecuado para uso en exteriores. El grosor total de la mesa es de 10 mm. vidrio + 12mm./0.5in. Compacto HPL.



Top Compacto HPL

12mm./0.5in. thick solid core high pressure laminate top (HPL). Suitable for outdoor and high traffic areas.
Sobre de mesa de 12mm./0.5in. de espesor, con cubierta laminada de alta presión y centro compacto (HPL). Adecuado para zonas exteriores y de alto tránsito.



Top Technical Stone

3mm./0.15in ceramic top + 5mm./0.2in glass board. Colors: brown earth, sand gray, stone gray. Valid for any central column collection. Suitable for outdoor use.
Tablero de mesa compuesto por una cubierta cerámica de 3mm./0.15in. + tablero de vidrio de 5mm./0.2in. Colores: Marrón tierra, Gris arena, Gris piedra. Válido para cualquier colección de columna central. Válido para su uso en exterior.



Plaza is a versatile, practical, contemporary and versatile central table base that adapts perfectly to collective uses and installations with high turnover. Available in two sizes, it accommodates table tops of different materials and shapes, starting with a foot in an essential shape and a round or square column in injected aluminum or wood, which gives it timelessness and naturalness.

Plaza es una base central de mesa versátil, práctica, actual y polivalente, que se adapta perfectamente a los usos colectivos e instalaciones con gran rotación. Disponible en dos medidas, se adapta a sobres de diferentes materiales y formas, a partir de un pie de forma esencial y de una columna redonda o cuadrada en aluminio inyectado o madera, que le aporta atemporalidad y naturalidad.

Plaza

by Estudio Andreu





◀ **BM1066 + SB4471**
Aluminum base and round column in white finish.
Lacquered top.
Base central con columna redonda y base de aluminio en acabado blanco con sobre lacado.

Cafeteria
Cafetería

▼ **BM1066 + SB0871 / SI2752**
Aluminum base and square column in black finish. Top 23 lacquered top.
Base central con columna cuadrada y base de aluminio en acabado negro con sobre Top 23 lacado.

Cafeteria
Cafetería

▶ **BM1082 + SB0828 / SI1302 / BQ1316**
Aluminum base and square column in white finish. Top 23 maple top.
Base central con columna cuadrada y base de aluminio en acabado blanco con sobre Top 23 arce.



Cafeteria
Cafeteria

▼ **BM1103 + SB1814** / BQ0637

Aluminum base and square column in black finish. Top 23 linoleum top.
Base central con columna cuadrada y base de aluminio en acabado negro con sobre Top 23 linóleo.

Educational
Educacional

► **BM1103 + SB0978** / BQ1316

Aluminum base and square column in matte black finish. Lacquered top.
Base de aluminio en acabado negro mate con sobre lacado.



Cafeteria
Cafeteria
 ▼ **BM1122 + SB0863 / SO2770**
 Central base in wood finish and maple top.
 Base central acabado madera y sobre de arce.



Base

Table base with central round or square column in solid beech or aluminum with square injected aluminum base available in matte white, matte black or polished aluminum finish. Able to be combined with any of the models from the Top Collection.

Base central de mesa con columna cuadrada o redonda disponible en madera maciza de haya y aluminio, y base cuadrada disponible en madera maciza de haya y aluminio. Combinable con cualquier modelo de la colección Top.

Beech
Haya

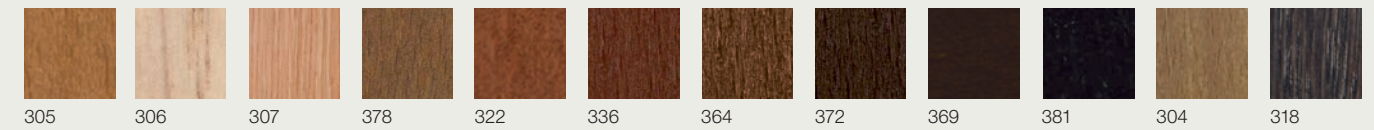

Premium finishes and wood lacquers
Acabados premium y lacados

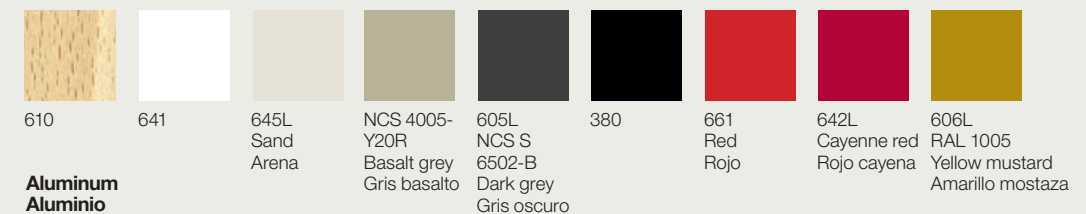

Aluminum
Aluminio

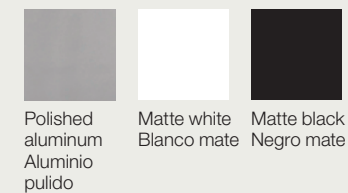

Measurements / Medidas



Sobres de mesa / Table tops

Top 18

18 mm./0.75in. thick table top with bevelled edge.
Sobre de mesa de 18mm./0.75in. de espesor con canto biselado.

Finishes / acabados

Oak / Roble
Laminated / Laminado
Lacquered / Lacado
Linoleum / Linóleo
Ultra-matte / Ultramate



Top 23

23mm./1in. thick two face table top finished in a maple veneer.
Sobres de 23mm. chapados arce a dos caras.

Lacquered / Lacado
Maple / Arce
Linoleum / Linóleo
Ultra-matte / Ultramate



Top 30 Square

30mm./1.18in. thick laminated table top.
Sobre de mesa laminado de 30mm./1.18in. de espesor.

Oak / Roble
Laminated / Laminado
Laminated TP / Laminado TP
Lacquered / Lacado
Linoleum / Linóleo
Ultra-matte / Ultramate
Ultra-matte TP / Ultramate TP



Top Solid Surface

12mm./0.5in. thick solid surface table top. Available in Glacier White color. Suitable for outdoor use.
Sobre de mesa de 12mm./0.5in. de espesor con canto biselado. Disponible en color blanco glaciar. Adecuado para uso en exteriores.

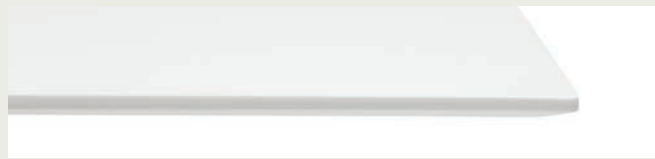

Sobres de mesa / Table tops

Top SP 40

Laminate table top, 40 mm / 1.18 in thickness and matching thermopolymer edge.
Sobre de mesa laminado de 40mm y con canto de termopolimero a juego.

Laminated / Laminado
Lacquered / Lacado
Linoleum / Linóleo
Ultra-matte / Ultramate

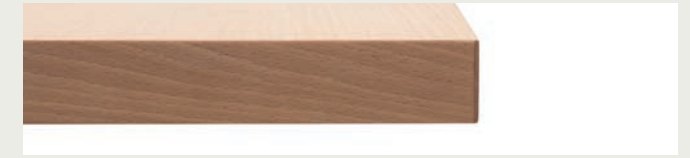

Top Glass 10

10mm./0.4in. thick tempered glass. Optical glass version available. Suitable for outdoor use. The total thickness of table top is 10mm. glass + 12mm./0.5in. compact HPL.
10mm./0.4in. Vidrio templado. Versión de cristal óptico disponible. Adecuado para uso en exteriores. El grosor total de la mesa es de 10 mm. vidrio + 12mm./0.5in. Compacto HPL.



Top Compacto HPL

12mm./0.5in. thick solid core high pressure laminate top (HPL). Suitable for outdoor and high traffic areas.
Sobre de mesa de 12mm./0.5in. de espesor, con cubierta laminada de alta presión y centro compacto (HPL). Adecuado para zonas exteriores y de alto tránsito.



Top Technical Stone

3mm./0.15in ceramic top + 5mm./0.2in glass board. Colors: brown earth, sand gray, stone gray. Valid for any central column collection. Suitable for outdoor use.
Tablero de mesa compuesto por una cubierta cerámica de 3mm./0.15in. + tablero de vidrio de 5mm./0.2in. Colores: Marrón tierra, Gris arena, Gris piedra. Válido para cualquier colección de columna central. Válido para su uso en exterior.



The cross design of the Quattro Collection provides a dynamic and sturdy solution in the most demanding contract environment without sacrificing lightness and performance. Additionally, its reduced size is the perfect response for the need of a versatile and discreet side table for sofas and lounge chairs.

Su base en cruz le confiere dinamismo y robustez para poder destacar en el contract más exigente sin renunciar a la ligereza y a los detalles de su cuidada ejecución, y su reducido tamaño da respuesta a la necesidad de mesa complementaria para sofás y butacas, con un diseño versátil y contenido.

Quattro

by Lievore Altherr Molina



► **BM4758 + SB3469**

Its base with casters gives dynamism to the spaces where they must be in constant movement, but without giving up lightness and the details of its careful execution. Its reduced size responds to the need for a complementary table with a versatile and contained design. Su base con ruedas le da dinamismo a los espacios donde deben estar en continuo movimiento, pero sin renunciar a la ligereza y a los detalles de su cuidada ejecución. Su reducido tamaño da respuesta a la necesidad de mesa complementaria con un diseño versátil y contenido.

▼ **BM4729 + SB4469**

Bar height aluminum central table base and lacquered top. Base central alta de aluminio pulido y sobre lacado.

▼ **BM4739 + SB4475**

Aluminum central table base in white finish and lacquered top. Base central de aluminio acabado en blanco y sobre lacado.



Cafeteria
Cafetería

▼ **BM4726 + SB3461 / SI1200**

Central base in polished aluminum finish and oak top. Base central con base cuatro aspas de aluminio pulido y sobre de roble.



▼ **BM4739 + SB4475**

▼ **BM4728 + SB3951**

Aluminum central table base in black finish and elliptic lacquered top.

Base central con base cuatro aspas de aluminio acabado en negro y sobre elíptico lacado.

▼ **BM4724 + SB4471**

Aluminum central table base in white finish and lacquered top.

Base central ocasional con base cuatro aspas de aluminio acabado en blanco y sobre lacado.

▼ **BM4729 + SB4469**

▼ **BM4734 + SB3963**

Occasional central base in black finish and elliptic oak top.

Base central ocasional con base cuatro aspas de aluminio acabado en negro y sobre elíptico de roble.

▼ **BM4724 + SB3462**

Occasional central base in white finish and oak top.

Base central ocasional con base cuatro aspas de aluminio acabado en blanco y sobre de roble.

Restaurant

Restaurante

► **BM4727 + SB3974** / S10653

Central base in black finish and ultra-matte top.

Base central con base cuatro aspas de aluminio negro y sobre ultramate.



▼ **BM4739 + SB3463**
Aluminum central table base
in black finish and oak top.
Base central de aluminio acabado
en negro y sobre de roble.



Base

Injected aluminum 4-star base. Available in 2 sizes and 4 heights and offered in polished aluminum, matte white or matte black. Combinable with all Top Collections.

Base de 4 aspas de inyección de aluminio. Disponible en 2 tamaños y 4 alturas diferentes. Se ofrece en acabados aluminio pulido, blanco mate o negro mate. Combinable con cualquier modelo de la colección Top.

Aluminum Aluminio

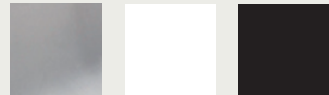

Polished aluminum
Aluminio pulido

Matte white
Blanco mate

Matte black
Negro mate

Measurements / Medidas



Measurements / Medidas



Sobres de mesa / Table tops

Top 18

18 mm./0.75in. thick table top with bevelled edge.
Sobre de mesa de 18mm./0.75in. de espesor con canto biselado.

Finishes / acabados

Oak / Roble
Laminated / Laminado
Lacquered / Lacado
Linoleum / Linóleo
Ultra-matte / Ultramate

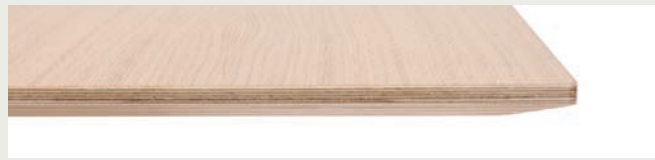

Top 23

23mm./1in. thick two face table top finished in a maple veneer.
Sobres de 23mm. chapados arce a dos caras.

Lacquered / Lacado
Maple / Arce
Linoleum / Linóleo
Ultra-matte / Ultramate



Top 30 Square

30mm./1.18in. thick laminated table top.
Sobre de mesa laminado de 30mm./1.18in. de espesor.

Oak / Roble
Laminated / Laminado
Laminated TP / Laminado TP
Lacquered / Lacado
Linoleum / Linóleo
Ultra-matte / Ultramate
Ultra-matte TP / Ultramate TP



Top Solid Surface

12mm./0.5in. thick solid surface table top. Available in Glacier White color. Suitable for outdoor use.
Sobre de mesa de 12mm./0.5in. de espesor con canto biselado. Disponible en color blanco glaciar. Adecuado para uso en exteriores.

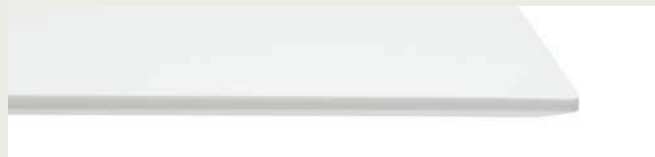

Sobres de mesa / Table tops

Top SP 40

Laminate table top, 40 mm / 1.18 in thickness and matching thermopolymer edge.
Sobre de mesa laminado de 40mm y con canto de termopolimero a juego.

Laminated / Laminado
Lacquered / Lacado
Linoleum / Linóleo
Ultra-matte / Ultramate

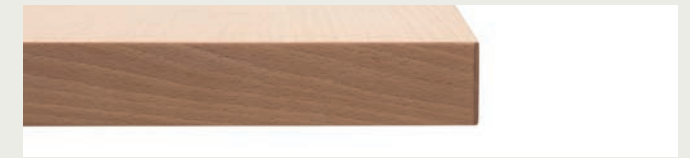

Top Glass 10

10mm./0.4in. thick tempered glass. Optical glass version available. Suitable for outdoor use. The total thickness of table top is 10mm. glass + 12mm./0.5in. compact HPL.
10mm./0.4in. Vidrio templado. Versión de cristal óptico disponible. Adecuado para uso en exteriores. El grosor total de la mesa es de 10 mm. vidrio + 12mm./0.5in. Compacto HPL.



Top Compacto HPL

12mm./0.5in. thick solid core high pressure laminate top (HPL). Suitable for outdoor and high traffic areas.
Sobre de mesa de 12mm./0.5in. de espesor, con cubierta laminada de alta presión y centro compacto (HPL). Adecuado para zonas exteriores y de alto tránsito.



Top Technical Stone

3mm./0.15in ceramic top + 5mm./0.2in glass board. Colors: brown earth, sand gray, stone gray. Valid for any central column collection. Suitable for outdoor use.
Tablero de mesa compuesto por una cubierta cerámica de 3mm./0.15in. + tablero de vidrio de 5mm./0.2in. Colores: Marrón tierra, Gris arena, Gris piedra. Válido para cualquier colección de columna central. Válido para su uso en exterior.



Created from a very basic shape, the Reverse collection of bases is a symbol of elegance and structural stability. Made from 100% recyclable polyethylene, Reverse bases combine perfectly with a wide range of tops of diverse finishes and functions.

Formulada a partir de una forma esencial, la colección de bases Reverse es un icono de elegancia y estabilidad estructural. Realizadas a partir de polietileno 100% reciclable, las bases Reverse combinan a la perfección con una gran variedad de sobres de acabados y prestaciones muy diversos.

Reverse

by Piergiorgio Cazzaniga





Cafeteria
Cafetería

◀ **BM4520 Reverse 38 + SB3462 / SO0916**
Polyethylene central base in matte finish with solid oak top.
Base central en polietileno acabado mate con sobre de roble.

Restaurant

▼ **BM4564 Reverse 60 + SB0956 / SI1450**
Polyethylene central base in black matte finish with lacquered top.
Base central en polietileno acabado en negro mate con sobre lacado.



Restaurant

Restaurante

▼ **BM4520 Reverse 38 + SB0826** / SI0612 + SI0610

Polyethylene central base in black
matte finish with maple top.

Base central en polietileno acabado
en negro mate con sobre de arce.



▼ **BM4562 Reverse 42 + SB3467** / BQ1313
Polyethylene central base in white matte finish with oak top.

Base central en polietileno acabado en negro mate con sobre de roble.

▼ **BM4562 Reverse 42 + SB3479**
Polyethylene central base in white matte finish with laminate top.

Base central en polietileno acabado en negro mate con sobre laminado.

▼ **BM4562 Reverse 42 + SB4581**
Polyethylene central base in white matte finish with compact top.

Base central en polietileno acabado en negro mate con sobre compacto.

**Residential
Hogar**

► **BM4521 Reverse 50 + SB0912** / SO1534
Polyethylene central base in white matte finish with maple top.

Base central en polietileno acabado en blanco mate con sobre de arce.



Base

Polyethylene central table base in matte or lacquer gloss finish. Offered in 4 diameters and 5 colors. Combinable with any Top collection models.

Base central de mesa de polietileno en acabado mate o laca brillo. Se ofrece en 4 diámetros de base y 5 colores diferentes. Combinable con cualquier modelo de la colección Top.

Polyethylene finish Acabado de polietileno

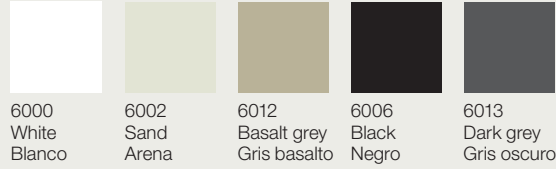

Measurements / Medidas

Reverse 38



Reverse 50



Reverse 60



Measurements / Medidas

Reverse 80



Reverse 42



Reverse 52



Sobres de mesa / Table tops

Top 18

18 mm./0.75in. thick table top with bevelled edge.
Sobre de mesa de 18mm./0.75in. de espesor con canto biselado.

Finishes / acabados

Oak / Roble
Laminated / Laminado
Lacquered / Lacado
Linoleum / Linóleo
Ultra-matte / Ultramate

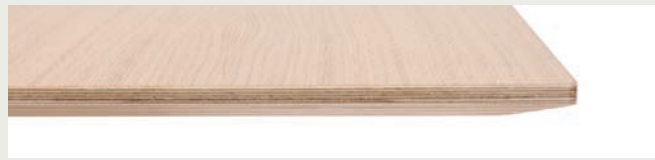

Top 23

23mm./1in. thick two face table top finished in a maple veneer.
Sobres de 23mm. chapados arce a dos caras.

Lacquered / Lacado
Maple / Arce
Linoleum / Linóleo
Ultra-matte / Ultramate



Top 30 Square

30mm./1.18in. thick laminated table top.
Sobre de mesa laminado de 30mm./1.18in. de espesor.

Oak / Roble
Laminated / Laminado
Laminated TP / Laminado TP
Lacquered / Lacado
Linoleum / Linóleo
Ultra-matte / Ultramate
Ultra-matte TP / Ultramate TP



Top Solid Surface

12mm./0.5in. thick solid surface table top. Available in Glacier White color. Suitable for outdoor use.
Sobre de mesa de 12mm./0.5in. de espesor con canto biselado. Disponible en color blanco glaciar. Adecuado para uso en exteriores.

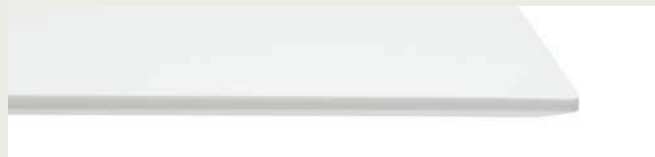

Sobres de mesa / Table tops

Top SP 40

Laminate table top, 40 mm / 1.18 in thickness and matching thermopolymer edge.
Sobre de mesa laminado de 40mm y con canto de termopolímero a juego.

Laminated / Laminado
Lacquered / Lacado
Linoleum / Linóleo
Ultra-matte / Ultramate

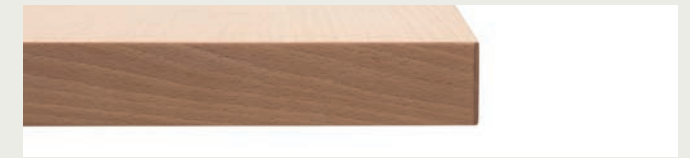

Top Glass 10

10mm./0.4in. thick tempered glass. Optical glass version available. Suitable for outdoor use. The total thickness of table top is 10mm. glass + 12mm./0.5in. compact HPL.
10mm./0.4in. Vidrio templado. Versión de cristal óptico disponible. Adecuado para uso en exteriores. El grosor total de la mesa es de 10 mm. vidrio + 12mm./0.5in. Compacto HPL.



Top Compacto HPL

12mm./0.5in. thick solid core high pressure laminate top (HPL). Suitable for outdoor and high traffic areas.
Sobre de mesa de 12mm./0.5in. de espesor, con cubierta laminada de alta presión y centro compacto (HPL). Adecuado para zonas exteriores y de alto tránsito.



Top Technical Stone

3mm./0.15in ceramic top + 5mm./0.2in glass board. Colors: brown earth, sand gray, stone gray. Valid for any central column collection. Suitable for outdoor use.
Tablero de mesa compuesto por una cubierta cerámica de 3mm./0.15in. + tablero de vidrio de 5mm./0.2in. Colores: Marrón tierra, Gris arena, Gris piedra. Válido para cualquier colección de columna central. Válido para su uso en exterior.



Arc Table represents the ideal combination instead utility and aesthetics to complement the environment. Made of oak, it communicates lightness and integrates perfectly with any sofa, armchair or furniture element that needs a subtle and differential auxiliary complement.

Arc Table representa la combinación ideal entre utilidad y estética para complementar el entorno. Fabricada en madera de roble, comunica ligereza y se integra a la perfección con cualquier sofá, sillón o elemento de mobiliario que necesite un complemento auxiliar sutil y diferencial.

Arc Table

by Manel Molina



Conference room
Sala de reunión
▼ ME5486 + ME5488 /
SF0300 + SF0302
Auxiliar table.
Mesa auxiliar.

► ME5486 + ME5488 /
SF0300 + SF0302



Waiting area
Sala de espera
▼ ME5488 / SF0727
Auxiliary table.
Mesa auxiliar.



Occasional tables / Mesas auxiliares

Occasional table made of plywood sheets, available in 2 heights, and in oak and lacquered finishes.

Mesa auxiliar hecha de laminas de contrachapado, disponible en 2 alturas, y en acabados roble y lacado.

Oak Roble

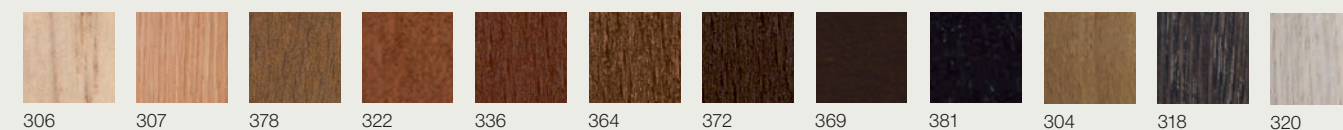

Premium finishes and wood lacquers Acabados premium y lacados



Measurements / Medidas

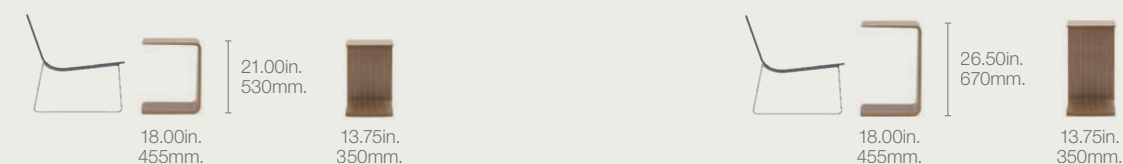

In line with the design of Couvé lounge chairs and sofas, this series of auxiliary tables offers square versions, in three different sizes, and rectangular, in two sizes. They are light tables, perfect as coffee tables or side table, which are characterized by the soft surface of their tops and the subtlety of their aluminum frame.

En sintonía con el diseño de las butacas y sofás Couvé, esta serie de mesas auxiliares ofrece versiones cuadradas, con tres medidas distintas, y rectangulares, en dos medidas. Son mesas ligeras, perfectas como mesas de centro o auxiliares, que se caracterizan por las suaves láminas de sus sobres y la sutileza de su estructura en aluminio.

Couvé Table

by Piergiorgio Cazzaniga



▼ **ME2183**

Auxiliary table with four injected aluminum legs in polished aluminum finish. Carrara marble top.

Mesa auxiliar con base de cuatro pies de inyección de aluminio en acabado aluminio pulido. Sobre mármol Carrara.

Waiting area

Sala de espera

► **ME2151 / BU1264**

Auxiliary table with four injected aluminum legs in polished aluminum finish. Carrara marble top.

Mesa auxiliar con base de cuatro pies de inyección de aluminio en acabado aluminio pulido. Sobre mármol Carrara.



**Waiting area
Sala de espera**

▼ **ME2183 / SF1266**
Auxiliary table with four injected aluminum legs in polished aluminum finish. Carrara marble top.

Mesa auxiliar con base de cuatro pies de inyección de aluminio en acabado aluminio pulido. Sobre mármol Carrara.



Occasional tables / Mesas auxiliares

Occasional table made of plywood sheets, available in 2 heights, and in oak and lacquered finishes, available in 2 heights. Available finishes include polished aluminum, matte white and black and plywood tops in different shapes and sizes in oak, lacquer, Technical Stone, HPL, white Carrara marble and black bamboo marble.

Mesa auxiliar con base de cuatro patas de inyección de aluminio, disponible en 2 alturas. En acabados, aluminio pulido, blanco mate o negro mate y sobres de diferentes formas y medidas en acabado roble, lacado, Technical Stone, Compacto HP, mármol Carrara y mármol negro bambú.

**Oak
Roble**



306 307 378 322 336 364 372 369 381 304 318 320

**Premium finishes and wood lacquers
Acabados premium y lacados**



610 641 645L Sand Arena NCS 4005-Y20R Basalt grey Gris basalto 605L NCS S 6502-B Dark grey Gris oscuro 380 661 Red Rojo 642L Cayenne red Rojo cayena 606L RAL 1005 Yellow mustard Amarillo mostaza

**Aluminum
Aluminio**

Polished aluminum Aluminio pulido Matte white Blanco mate Matte black Negro mate

**Marble top
Sobres marmol**

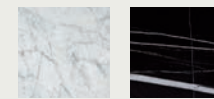

Carrara Bamboo Bambú

Measurements / Medidas

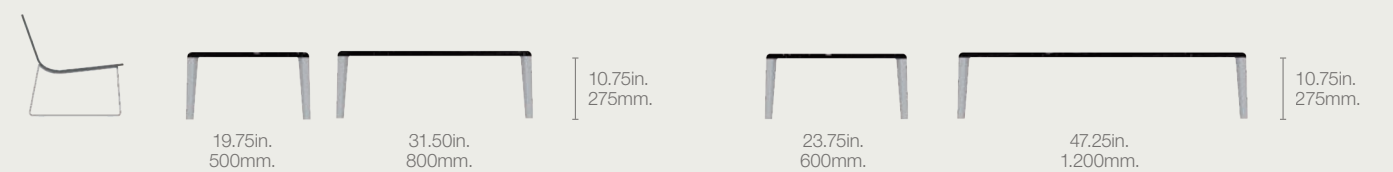

Lightweight, sleek and with the same functional spirit as Dual, this occasional table goes well with sofas and lounge chairs. The oval shape of the column provides a balanced, timeless and unique design. Dual Occasional is available in two heights and three different shaped tops: round, square and elliptical.

Ligera, esbelta y con el mismo espíritu funcional de Dual, esta mesa auxiliar complementa a sofás y butacas. Tiene un diseño equilibrado, atemporal, singular gracias a la forma ovalada de su columna. Está disponible en dos alturas y tres formas de sobre diferentes, redondo, cuadrado y elíptico.

Dual Occasional

by Lievore Altherr Molina



▼ **ME6392**

Low aluminum central base in matte black finish and lacquered top.
Base central de aluminio en acabado negro mate con sobre lacado.

▼ **ME6356**

Occasional aluminum table in matte white finish and round lacquered top.
Mesa auxiliar de aluminio en acabado blanco mate y sobre redondo lacado.

**Residential
Hogar**

► **ME6356 / BU1524**

Occasional aluminum table in matte black finish and round lacquered top.
Mesa auxiliar de aluminio en acabado negro mate y sobre redondo lacado.



276

Dual Occasional



Dual Occasional

277



**Waiting area
Zona de espera**

◀ **ME6356** / BU1264

Low aluminum central base in matte black finish and laquered top.
Base central de aluminio en acabado negro mate con sobre lacado

◀ **ME6413** / SF1266

Low aluminum central base in matte black finish and marble top.
Base central de aluminio en acabado negro mate con sobre de mármol.

**Waiting area
Zona de espera**

▼ **ME6447** / BU4201

Occasional aluminum table in matte black finish and round compact top.
Mesa auxiliar de aluminio en acabado negro mate y sobre redondo compacto.



Waiting area

Zona de espera

▼ **ME6365** / SF2116

Low aluminum central base in matte black finish and lacquered top.
Base central de aluminio en acabado negro mate con sobre lacado.

▼ **ME6356** / BU2114

Low aluminum central base in matte black finish and lacquered top.
Base central de aluminio en acabado negro mate con sobre lacado.



Occasional tables / Mesas auxiliares

Table with injected aluminum circular base and oval column, available in 2 heights. Available finishes include polished aluminum, matte white and black and plywood tops in different shapes and sizes in oak, lacquer, Technical Stone, HPL, Carrara marble and black bamboo marble.

Mesa auxiliar con base circular y columna ovalada de inyección de aluminio, disponible en 2 alturas. En acabados aluminio pulido, blanco mate o negro mate y sobres de tablero de diferentes formas y medidas en acabado roble, lacado, solid surface, Technical Stone, Compacto HPL, mármol Carrara y mármol negro bambú.

Oak Roble

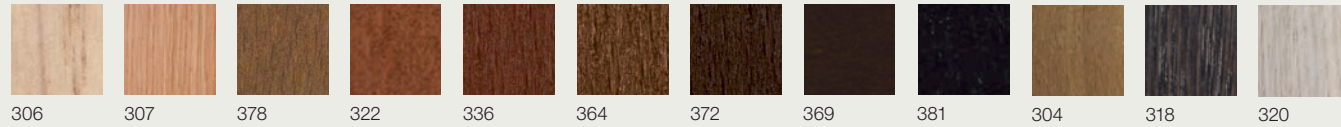

Premium finishes and wood lacquers Acabados premium y lacados



Compacto HPL

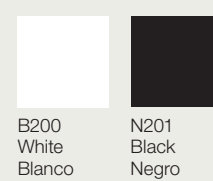

Aluminum Aluminio

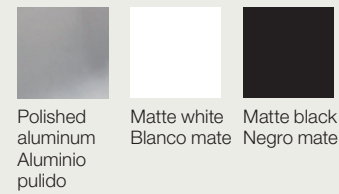

Marble top Sobres marmol

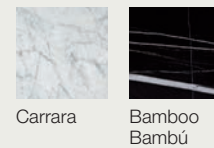

Technical stone

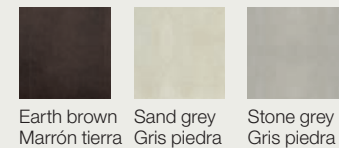

Solid Surface finish



Measurements / Medidas

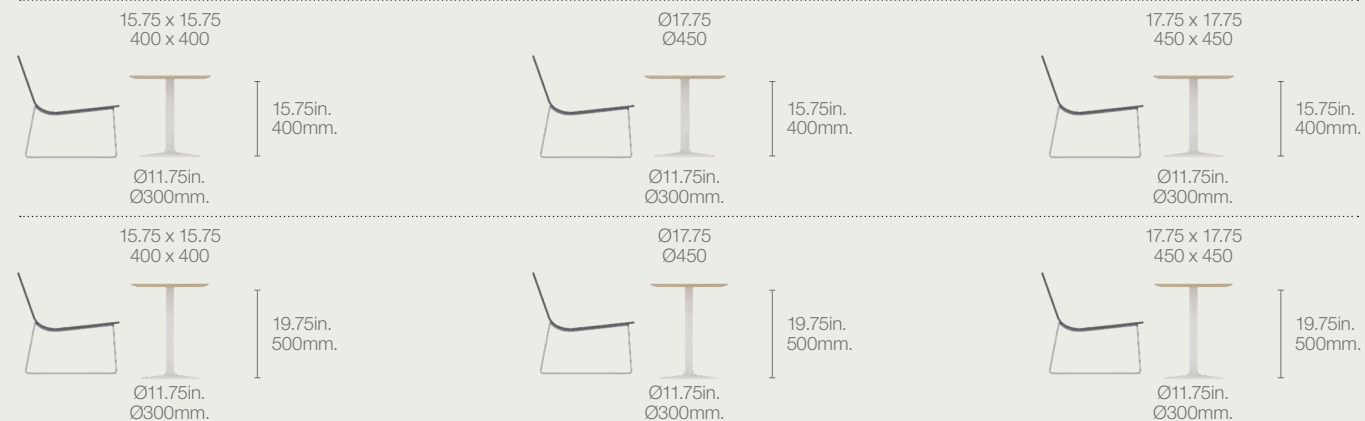

Sobres de mesa / Table tops

Top 18

18 mm./0.75in. thick table top with bevelled edge. Sobre de mesa de 18mm./0.75in. de espesor con canto biselado.

Finishes / acabados

Oak / Roble Laminated / Laminado Lacquered / Lacado Linoleum / Linóleo Ultra-matte / Ultramate

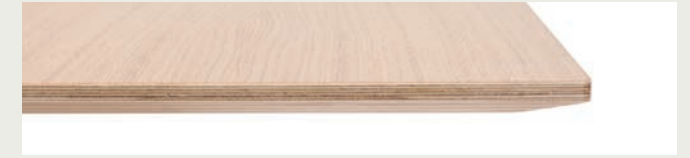

Top 20 Marble Razor

20mm/0.80in. marble table top with bevelled edge. Sobre de mesa de mármol de 20mm/0.80in. de espesor con canto biselado



Top 20 Marble Square

20mm/0.80in. marble table top. Sobre de mesa de mármol de 20mm/0.80in. de espesor



Top Solid Surface

12mm./0.5in. thick solid surface table top. Available in Glacier White color. Suitable for outdoor use. Sobre de mesa de 12mm./0.5in. de espesor con canto biselado. Disponible en color blanco glaciar. Adecuado para uso en exteriores.

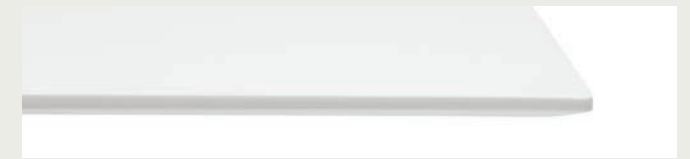

Top Compacto HPL

12mm./0.5in. thick solid core high pressure laminate top (HPL). Suitable for outdoor and high traffic areas. Sobre de mesa de 12mm./0.5in. de espesor, con cubierta laminada de alta presión y centro compacto (HPL). Adecuado para zonas exteriores y de alto tránsito.



Top Technical Stone

3mm./0.15in ceramic top + 5mm./0.2in glass board. Colors: brown earth, sand gray, stone gray. Valid for any central column collection. Suitable for outdoor use. Tablero de mesa compuesto por una cubierta cerámica de 3mm./0.15in. + tablero de vidrio de 5mm./0.2in. Colores: Marrón tierra, Gris arena, Gris piedra. Válido para cualquier colección de columna central. Válido para su uso en exterior.



The idea of evolution is a fundamental element of our work, both in the production and in the development of new designs. Element responds to this criterion and is presented as a tubular table base capable of combining with square, rectangular or round tops, conceived to provide elegant and functional solutions for all types of spaces.

La idea de evolución es un elemento fundamental de nuestro trabajo, tanto en la producción como en el desarrollo de nuevos diseños. Element responde a este criterio y se presenta como una base que se combina con sobres cuadrados, rectangulares y redondos, concebida para aportar soluciones elegantes y funcionales a todo tipo de espacios.

Element Table

by Estudio Andreu-Product Design Consulting Gensler



Residential
Hogar

▼ 2x ME1031/

SF0363+2xSF0301+SF0361+SF0362

Auxiliary table. Four-legged steel tube base.

Smoked gray glass table top.

Mesa auxiliar de tubo de acero con cuatro
pies y sobre de cristal fumé.



Waiting area
Zona de espera

► 2x **ME1031**/ SF1137+BU1135
Auxiliary table. Four-legged steel tube base.
Smoked gray glass table top.
Mesa auxiliar de tubo de acero con cuatro
pies y sobre de cristal fumé.

▼ **ME1043**
Auxiliary table. Four-legged steel tube base.
Smoked gray glass table top.
Mesa auxiliar de tubo de acero con cuatro
pies y sobre de cristal fumé.

▼ 2x **ME1031**
Auxiliary table. Four-legged steel tube base.
Smoked gray glass table top.
Mesa auxiliar de tubo de acero con cuatro
pies y sobre de cristal fumé.



Tops / Sobres

Occasional table with glass tops in different shapes and sizes finished in transparent or smoked gray.

Mesa auxiliar con sobres de cristal en diferentes formas y medidas en acabado transparente o fumé gris.



Glass Cristal



Transparent Smoked gray
Trasparente Fume gris

Top Glass 10

10mm/0.40in. thick table top, tempered glass, with optical glass version available. The total thickness of the table is 10 mm. glass.

Sobre de mesa de 10mm/0.40in. de espesor, de vidrio templado, con versión de cristal óptico disponible. El grosor total de la mesa es de 10 mm.



Legs / Pies

Occasional table with 4 legs steel tube base finished in white, black or polished chrome. Available in 3 heights.

Mesa auxiliar con base de 4 patas de tubo de acero y acabado blanco, negro o cromo brillo. Disponible en tres alturas.

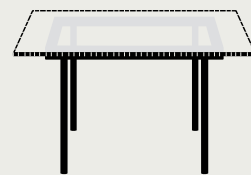

Steel Acero



Polished chrome White Black
Cromo pulido Blanco Negro

Occasional tables / Mesas auxiliares



Available in a range of sizes and forms the Nuez Occasional Table is a extremely versatile piece for any living area. they are developed from a pyramidal bases with ash wood legs, in different heights. its round table tops are also available in several diameters. The occasional version is designed to easy place beside sofas or lounge chairs –whether as a coffee or as a side table, suitable for all types of projects and uses, in workspaces, waiting areas or lobbies, and also at home.

Disponible en variedad de tamaños y formas. Nuez Occasional Table es una pieza extremadamente versátil para cualquier zona de living. Está desarrollada a partir de bases piramidales con patas de madera de fresno, en diferentes alturas. Sus mesas redondas también están disponibles en varios diámetros. La versión ocasional está diseñada para ubicarse fácilmente al lado de sofás o sillones, ya sea como mesa de café o mesa auxiliar, adecuada para todo tipo de proyectos y usos, en espacios de trabajo, áreas de espera o lobbies, y también en el hogar.

Nuez Occasional Table

by Patricia Urquiola



▼ **ME2872**

Auxiliary table with lacquered top and ash legs.
Mesa auxiliar con sobre lacado y pies de fresno.

▼ **ME2880**

Auxiliary table with oak top and ash legs.
Mesa auxiliar con sobre de roble y pies de fresno.

Waiting area

Zona de espera

► **ME2872**/ 2x SF0301+SF0362

Auxiliary table with oak top and ash legs.
Mesa auxiliar con sobre de roble y pies de fresno.

► **ME2880**/ 2x SF0301+SF0362

Auxiliary table with oak top and ash legs.
Mesa auxiliar con sobre de roble y pies de fresno.



Tops/Sobres

Table tops in oak wood, marble, lacquered wood, laminate wood, ultramate, linoleum or Compacto HPL. Round table tops only version, in different sizes. Available in 2 heights.

Sobres de mesa en diferentes acabados madera de roble, mármol, madera lacada, madera laminada, ultramate, linóleo o Compacto HPL. Sobres de mesa sólo redondos, en varias medidas. Disponible en 2 alturas.

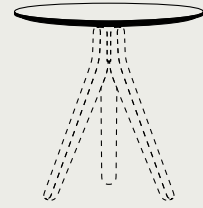

Oak Roble

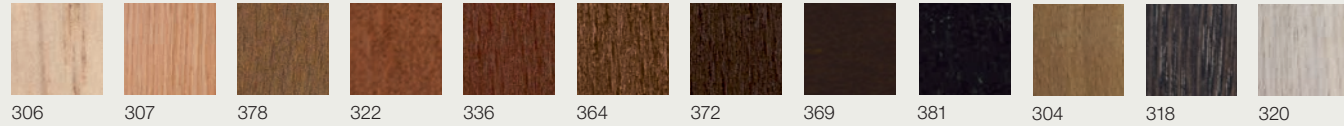

Premium finishes and wood lacquers Acabados premium y lacados

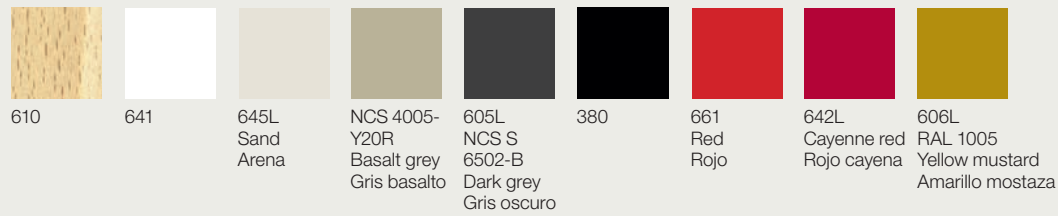

Compacto HPL

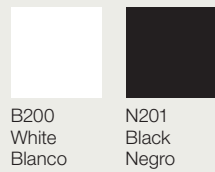

Linoleum Linóleo

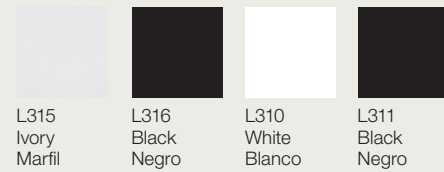

Ultra-matte Ultramate

Solid Surface finish



Marble top Sobres marmol

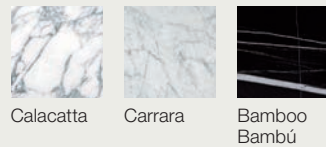

Tops/Sobres

Top 18

18 mm./0.75in. thick table top with bevelled edge. Sobre de mesa de 18mm./0.75in. de espesor con canto biselado.

Oak / Roble
Laminated / Laminado
Lacquered / Lacado
Linoleum / Linóleo
Ultra-matte / Ultramate



Top Compacto HPL

12mm/0.50in. thick table top, composed of a compact center high pressure laminate (HPL). Sobre de mesa de 12mm/0.50in. de espesor, compuesto por un laminado de alta presión de centro compacto (HPL)



Top 20 Marble Square

20mm/0.80in. marble table top. Sobre de mesa de mármol de 20mm/0.80in. de espesor



Legs/Pies

Table program with central base in ash wood.

Programa de mesas disponible con base central en madera de fresno.

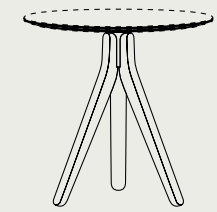

Ash Fresno

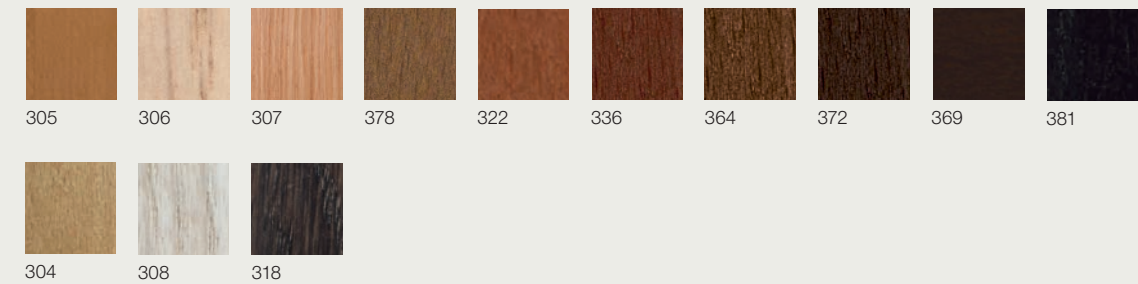

Occasional tables / Mesas auxiliares



Designed to satisfy the most demanding project needs, the Quattro Occasional table collection stands out for its lightness, sturdiness and dynamic design. Its reduced size makes it ideal as an occasional table next to sofas or lounge chairs.

Concebida para satisfacer los proyectos más exigentes, la colección de mesas Quattro Occasional destaca por su ligereza, robustez y dinamismo. Su tamaño reducido la hace idónea como mesa auxiliar de sofás y butacas.

Quattro Occasional

by Lievore Altherr Molina



► **ME6709**
Occasional aluminum table in matte white finish and square lacquered top.
Mesa auxiliar de aluminio en acabado blanco mate y sobre cuadrado lacado.

Waiting area
Zona de espera

▼ **ME6769** / BU1530
Occasional aluminum table in black finish and round marble top.
Mesa auxiliar de aluminio en acabado negro y sobre redondo de mármol.

Waiting area
Zona de espera

► **ME6769** / BU1530
Occasional aluminum table in black finish and round lacquered top.
Mesa auxiliar de aluminio en acabado negro y sobre redondo lacado.

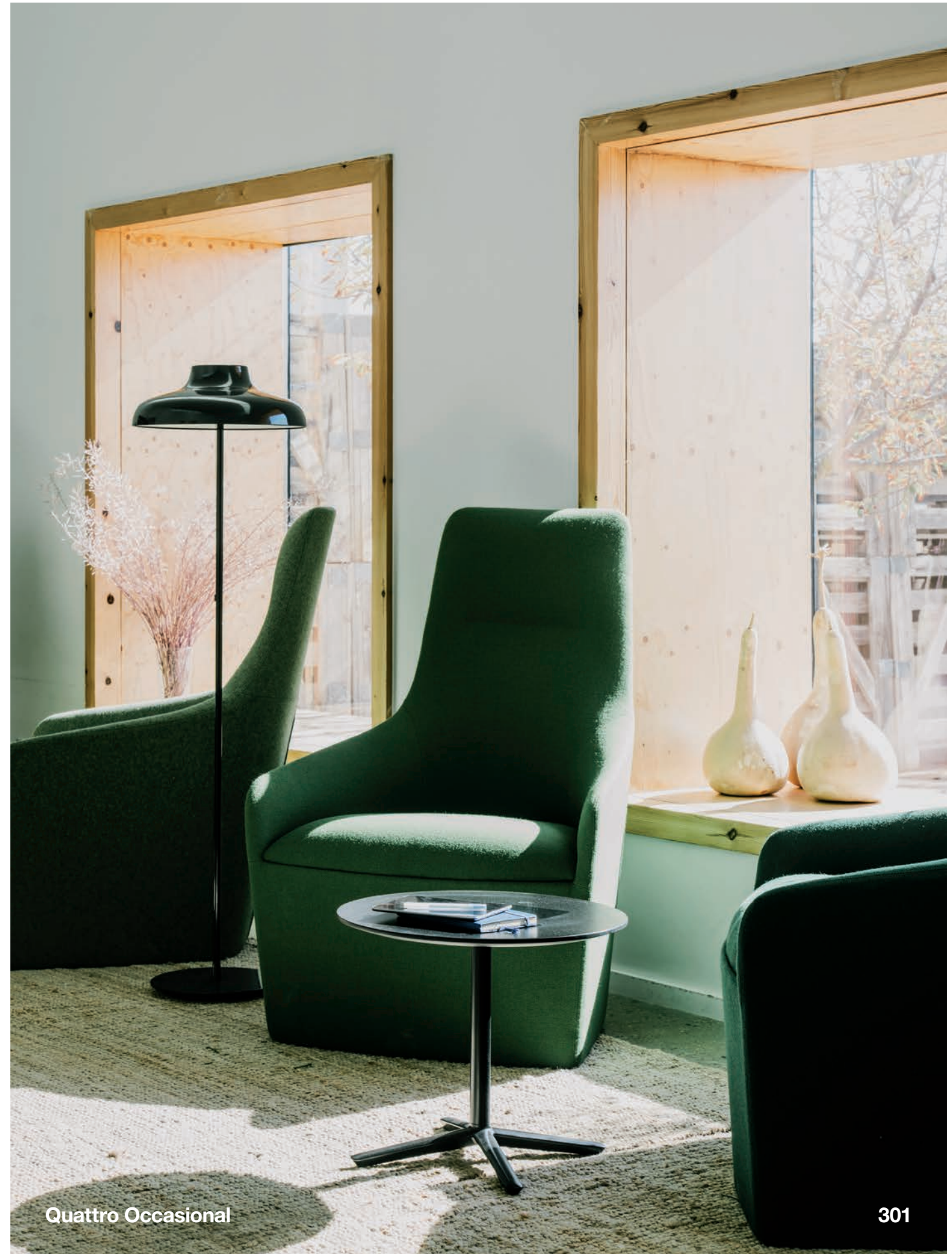

Waiting area

Zona de espera

▼ **ME6715 + ME6706** / 2x SF2115

Occasional aluminum table in black finish and round lacquered top.
Mesa auxiliar de aluminio en acabado negro y sobre redondo lacado.

▼ **ME6769** / SF 2116

Occasional aluminum table in black finish and round marble top.
Mesa auxiliar de aluminio en acabado negro y sobre redondo mármol.



Occasional tables / Mesas auxiliares

Occasional table with 4-star aluminum foot and injected aluminum column, available in 2 heights. Finishes include polished aluminum, matte white and black and board tops of different shapes and sizes in oak, lacquer, Solid Surface, Technical Stone, HPL, Carrara marble and black bamboo marble finish.

Mesa auxiliar con base de 4 aspas de aluminio y columna de inyección de aluminio, disponible en 2 alturas. En acabados aluminio pulido, blanco mate o negro mate y sobres de tablero de diferentes formas y medidas en acabado roble, lacado, solid surface, Technical Stone, Compacto HPL, mármol Carrara, y mármol negro bambú.

Oak Roble

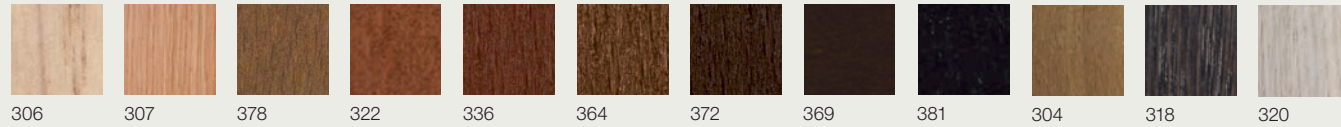

Premium finishes and wood lacquers Acabados premium y lacados



Compacto HPL

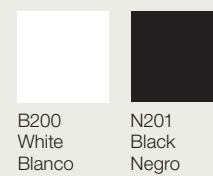

Aluminum Aluminio

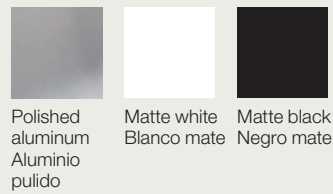

Marble top Sobres marmol

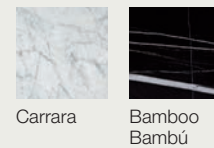

Technical stone

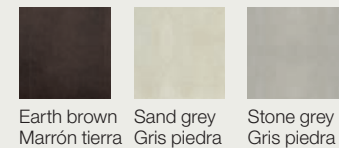

Solid Surface finish



Measurements / Medidas

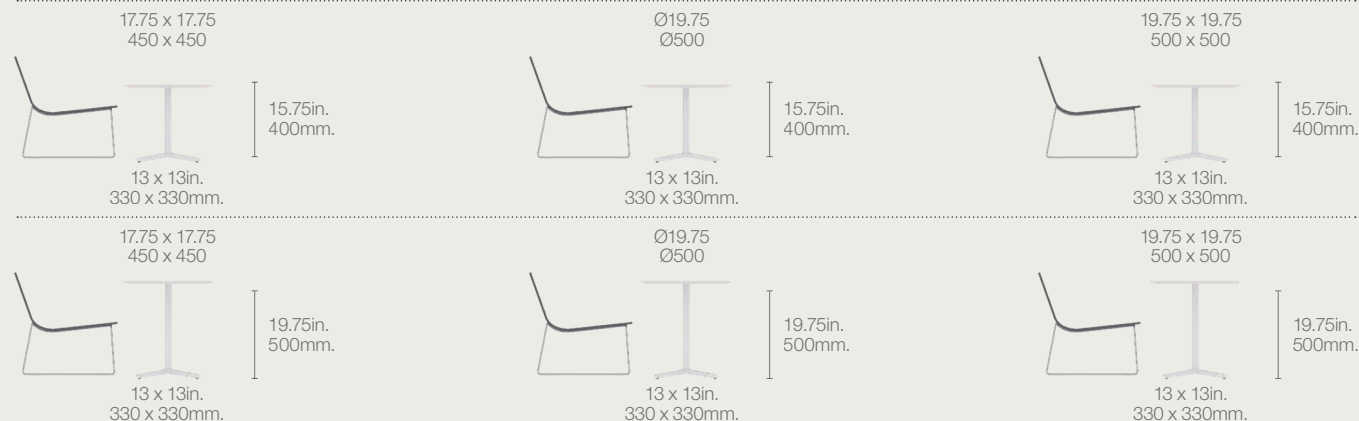

Sobres de mesa / Table tops

Top 18

18 mm./0.75in. thick table top with bevelled edge.
Sobre de mesa de 18mm./0.75in. de espesor con canto biselado.

Finishes / acabados

Oak / Roble
Laminated / Laminado
Lacquered / Lacado
Linoleum / Linóleo
Ultra-matte / Ultramate

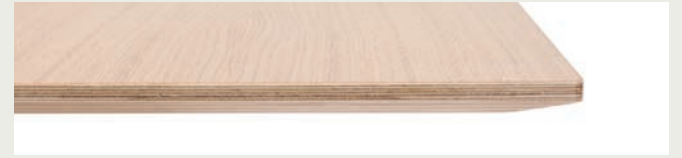

Top 20 Marble Razor

20mm/0.80in. marble table top with bevelled edge.
Sobre de mesa de mármol de 20mm/0.80in. de espesor con canto biselado



Top 20 Marble Square

20mm/0.80in. marble table top.
Sobre de mesa de mármol de 20mm/0.80in. de espesor



Top Solid Surface

12mm./0.5in. thick solid surface table top. Available in Glacier White color. Suitable for outdoor use.
Sobre de mesa de 12mm./0.5in. de espesor con canto biselado. Disponible en color blanco glaciar. Adecuado para uso en exteriores.

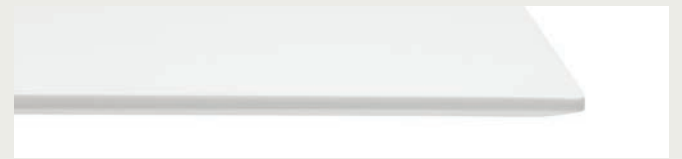

Top Compacto HPL

12mm./0.5in. thick solid core high pressure laminate top (HPL). Suitable for outdoor and high traffic areas.
Sobre de mesa de 12mm./0.5in. de espesor, con cubierta laminada de alta presión y centro compacto (HPL). Adecuado para zonas exteriores y de alto tránsito.



Top Technical Stone

3mm./0.15in ceramic top + 5mm./0.2in glass board. Colors: brown earth, sand gray, stone gray. Valid for any central column collection. Suitable for outdoor use.
Tablero de mesa compuesto por una cubierta cerámica de 3mm./0.15in. + tablero de vidrio de 5mm./0.2in. Colores: Marrón tierra, Gris arena, Gris piedra. Válido para cualquier colección de columna central. Válido para su uso en exterior.



Developed developed together with the Raglan Sofa system, this occasional table has four aluminum legs and a wide variety of tops in different materials. It is discreet, essential, and functional.

Desarrollada junto al programa de sofás Raglan, esta mesa auxiliar cuenta con una base de cuatro patas de aluminio y con una gran variedad de sobres de distintos materiales. Es discreta, esencial y funcional.

Raglan Table

by Piergiorgio Cazzaniga





◀ **ME8962**

Occasional table with four aluminum legs in black matte finish and bamboo marble top.

Mesa ocasional con base de cuatro patas de aluminio en acabado negro mate y sobre de mármol bambú.

Waiting area

Zona de espera

◀ **ME8525** / SF2066

Occasional table with four aluminum legs in black matte finish and lacquered top.

Mesa ocasional con base de cuatro patas de aluminio en acabado negro mate y sobre lacado.

◀ **ME8627** / SF2066

Occasional table with four aluminum legs in black matte finish and marble top.

Mesa ocasional con base de cuatro patas de aluminio en acabado negro mate y sobre de mármol.

Waiting area

Zona de espera

▼ **ME8525** / SF2066 + SF2070

Occasional table with four aluminum legs in black matte finish and lacquered top.

Mesa ocasional con base de cuatro patas de aluminio en acabado negro mate y sobre lacado.

▼ **ME8627** / SF2066 + SF2070

Occasional table with four aluminum legs in black matte finish and marble top.

Mesa ocasional con base de cuatro patas de aluminio en acabado negro mate y sobre de mármol.



▼ **ME8525**

Occasional table with four aluminum legs in black matte finish and marble top.
Mesa ocasional con base de cuatro patas de aluminio en acabado negro mate y sobre de mármol.



Occasional tables / Mesas auxiliares

Table with 4 injected aluminum legs, available in 2 heights. Available finishes include polished aluminum, matte white, black and polished chrome and plywood tops in different shapes and sizes in oak, lacquer, Technical Stone, HPL, Solid Surface, Carrara marble and black bamboo marble.

Mesa auxiliar con base de 4 patas de inyección de aluminio, disponible en 2 alturas. En acabados aluminio pulido, blanco mate, negro mate y cromado pulido, y sobres de diferentes formas y medidas en acabado roble, lacado, solid surface, Technical Stone, Compacto HPL, mármol Carrara, y mármol negro bambú.

Oak Roble

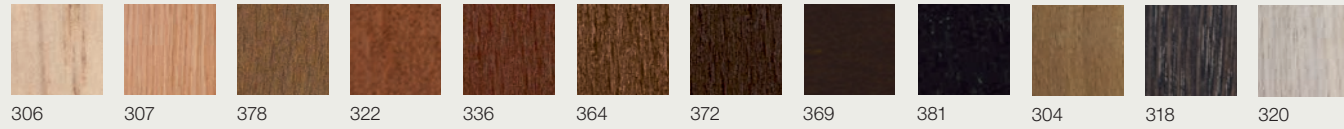

Premium finishes and wood lacquers Acabados premium y lacados

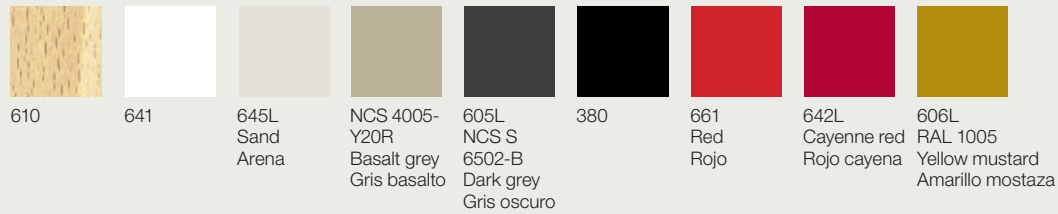

Aluminum Aluminio

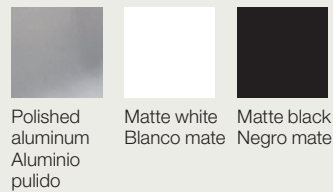

Marble top Sobres marmol

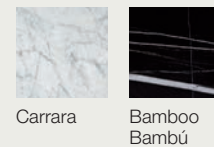

Compacto HPL

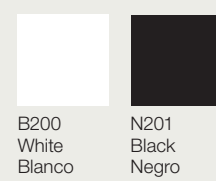

Solid Surface finish



Measurements / Medidas

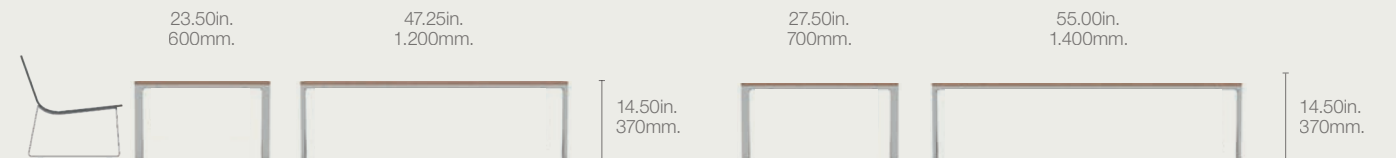

Reverse is one of our most iconic and versatile table collections. Now the collection has been expanded to include an occasional tables, in two base heights and two table top diameters.

Reverse es una de nuestras mesas más icónicas y versátiles. Ahora ha evolucionado como mesa ocasional, con dos alturas de base y dos diámetros de sobre.

Reverse Occasional

by Piergiorgio Cazzaniga



Waiting area
Sala de espera
Reverse Ocasional 55
▼ ME5128 / SO1845
Polyethylene central base in matte black finish with marble top.
Base central en polietileno acabado negro mate con sobre de mármol.
Reverse Ocasional 45
▼ ME5110 / SO1845
Polyethylene central base in matte black and lacquered top.
Base central en polietileno acabada en negro mate y sobre lacado.



Waiting area
Zona de espera
Reverse Ocasional 55
▼ ME5128 / BU1693
Polyethylene central base in matte black finish with marble top.
Base central en polietileno acabado negro mate con sobre de mármol.
Reverse Ocasional 45
▼ ME5110 / BU1693
Polyethylene central base in matte black finish with lacquered top.
Base central en polietileno acabado negro mate con sobre lacado.
Reverse Ocasional 55
▼ ME5125 / BU1693
Polyethylene central base in matte black finish with lacquered top.
Base central en polietileno acabado negro mate con sobre lacado.



Waiting area
Zona de espera
Reverse Ocasional 55
▼ ME5125 / SF1266

Polyethylene central base in matte white finish with lacquered top.
Base central en polietileno acabado blanco mate con sobre lacado.

Reverse Ocasional 45
► ME5110 / SF1265

Polyethylene central base in matte basalt finish with lacquered top.
Base central en polietileno acabado basalto mate con sobre lacado.

Reverse Ocasional 55
► ME 126 / SF1265

Polyethylene central base in matte black finish with oak top.
Base central en polietileno acabado negro mate con sobre de roble.



Waiting area
Zona de espera
Reverse Ocasional 55
▼ ME5125 / SF1266

Polyethylene central base in matte white finish with lacquered top.
Base central en polietileno acabado blanco mate con sobre lacado.

Reverse Ocasional 45
► ME5110 / SF1265

Polyethylene central base in matte basalt finish with lacquered top.
Base central en polietileno acabado basalto mate con sobre lacado.

Reverse Ocasional 55
► ME 126 / SF1265

Polyethylene central base in matte black finish with oak top.
Base central en polietileno acabado negro mate con sobre de roble.



Reverse Occasional 55

► **ME5485**

Marble central base with marble top.
Base central en mármol y con sobre de mármol.

Reverse Occasional 45

► **ME5482**

Marble central base with marble top.
Base central en mármol y con sobre de mármol.

Reverse Occasional 35

▼ **ME5475**

Marble central base with marble top.
Base central en mármol y con sobre de mármol.

Waiting area

Sala de espera

Reverse Occasional 35

► **ME5327** / BU1693

Polyethylene central base in matte black finish with marble top.
Base central en polietileno acabado negro mate con sobre de mármol.

Reverse Occasional 45

► **ME5110** / BU1693

Polyethylene central base in matte black and lacquered top.

Base central en polietileno acabada en negro mate y sobre lacado.

Reverse Occasional 55

► **ME5128** / BU1693

Polyethylene central base in matte black finish with marble top.

Base central en polietileno acabado negro mate con sobre de mármol.



Waiting area
Sala de espera
Reverse Ocasional 55
▼ ME5485 / BU1693
Marble central base
with marble top.
Base central en mármol
con sobre de mármol.



Waiting area
Sala de espera
Reverse Ocasional 35
▼ ME5475 / BU1539
Cement central base
with cement top.
Base central en cemento
con sobre de cemento.
Reverse Ocasional 45
▼ ME5462
Cement central base
with cement top.
Base central en cemento
con sobre de cemento.



Tops / Sobres

Program of occasional tables available with tops of different shapes and sizes in oak, lacquered, solid surface, Technical Stone, HPL Compact, Carrara marble, and black bamboo marble finishes.

Programa de mesas auxiliares disponible con sobres de diferentes formas y medidas en acabado roble, lacado, solid surface, Technical Stone, Compacto HPL, mármol Carrara, y mármol negro bambú.

Oak Roble

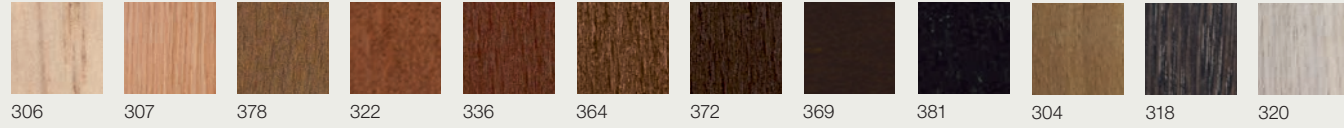

Premium finishes and wood lacquers Acabados premium y lacados

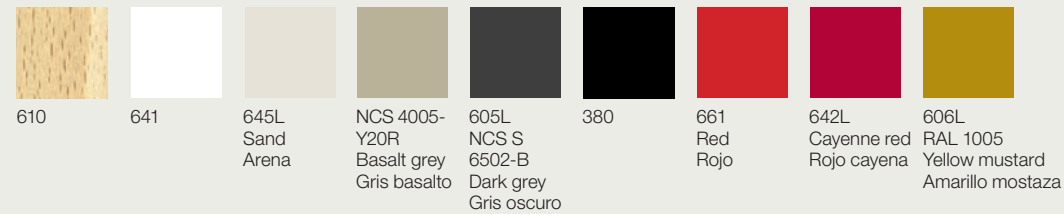

Compacto HPL

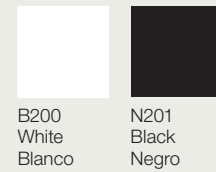

Aluminum Aluminio

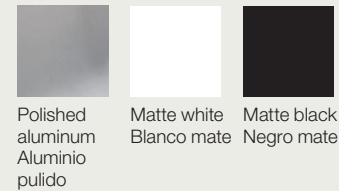

Marble top Sobres marmol

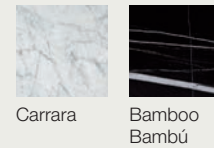

Technical stone

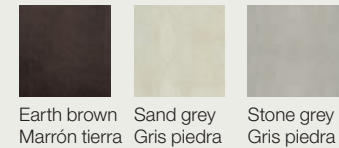

Solid Surface finish



Cement Cemento

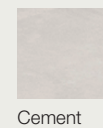

Sobres de mesa / Table tops

Top 18

18 mm./0.75in. thick table top with bevelled edge.
Sobre de mesa de 18mm./0.75in. de espesor con canto biselado.

Finishes / acabados

Oak / Roble
Laminated / Laminado
Lacquered / Lacado
Linoleum / Linóleo
Ultra-matte / Ultramate



Top 20 Marble Razor

20mm/0.80in. marble table top with bevelled edge.
Sobre de mesa de mármol de 20mm/0.80in. de espesor con canto biselado



Top 20 Marble Square

20mm/0.80in. marble table top.
Sobre de mesa de mármol de 20mm/0.80in. de espesor



Top Solid Surface

12mm./0.5in. thick solid surface table top. Available in Glacier White color. Suitable for outdoor use.
Sobre de mesa de 12mm./0.5in. de espesor con canto biselado. Disponible en color blanco glaciar. Adecuado para uso en exteriores.

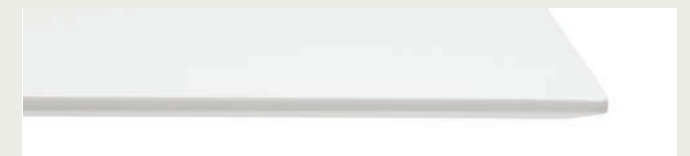

Top Compacto HPL

12mm./0.5in. thick solid core high pressure laminate top (HPL). Suitable for outdoor and high traffic areas.
Sobre de mesa de 12mm./0.5in. de espesor, con cubierta laminada de alta presión y centro compacto (HPL). Adecuado para zonas exteriores y de alto tránsito.



Top Technical Stone

3mm./0.15in ceramic top + 5mm./0.2in glass board. Colors: brown earth, sand gray, stone gray. Valid for any central column collection. Suitable for outdoor use.
Tablero de mesa compuesto por una cubierta cerámica de 3mm./0.15in. + tablero de vidrio de 5mm./0.2in. Colores: Marrón tierra, Gris arena, Gris piedra. Válido para cualquier colección de columna central. Válido para su uso en exterior.



Legs / Patas

Program of occasional tables available with different types of central polyethylene bases, available in various colors and in cement and Carrara marble finishes.

Programa de mesas auxiliares disponible con diferentes tipos de bases centrales de polietileno, disponible en varios colores y en acabado cemento y mármol carrara.

Thermo-polymer Termopolímero



Marble Mármol

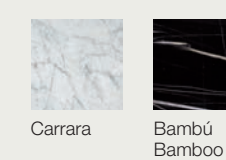

Cement Cemento

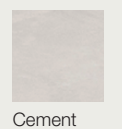

Tops / Sobres

Occasional table with central base and top in ash wood, with centre top in marble, lacquered wood or technical stone 8. Round table tops only version, in 2 sizes. Available in 2 heights.

Mesa auxiliar con base central y sobre en madera de fresno, con centro en diferentes acabados, mármol, madera lacada o technical stone 8. Sobres de mesa sólo redondos, en dos medidas. Disponible en 2 alturas.

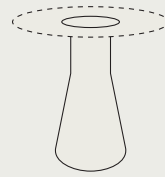

Ash Fresno



305 306 307 378 322 336 364 372 369 381

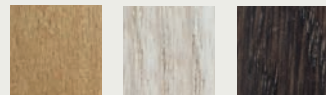

304 308 318

Premium finishes and wood lacquers Acabados premium y lacados



610 641 645L Sand Arena NCS 4005-Y20R Basalt grey Gris basalto 605L NCS S 6502-B Dark grey Gris oscuro 380 661 Red Rojo 642L Cayenne red Rojo cayena 606L RAL 1005 Yellow mustard Amarillo mostaza

Technical stone 8

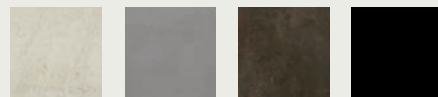

DKAR Sand Arena DKRC Rock grey Gris roca DKMR Earth brown Marrón tierra DKNG Black Negro

Marble top Sobres marmol

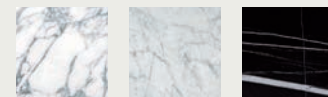

Calacatta Carrara Bamboo Bambú

Bases

Table program with central base in ash.

Programa de mesas disponible con bases centrales de madera de fresno.

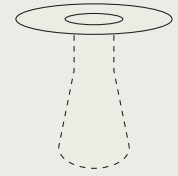

Ash Fresno

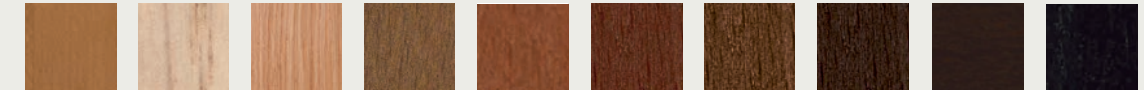

305 306 307 378 322 336 364 372 369 381

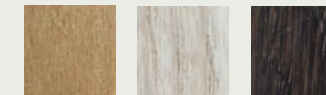

304 308 318

Occasional tables / Mesas auxiliares

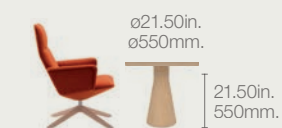

Wire management / Conectividad

America

Distribution Distribución

1. Power boxes distribution: By standard, the power/data box would be offset relative to the base. For tables with more than one power box, these will be separated 1/3 between them and placed horizontally and longitudinally.

2. Wire management: The cable passes through an aluminum wire manager, keeping it hidden from the users.

3. Wiring exit: the cable exits directly from the power system or through an aluminum frame so that it is concealed at the bottom of the base. The cable then crosses the aluminum profiles of the legs and is completely hidden until it reaches the floor.

1. Distribución de sistemas: De serie, el sistema de conexiones se dispondrá en el centro de la mesa. Para las mesas con más de un sistema, estos se colocarán con una separación de 1/3 de la longitud total de la mesa y en sentido longitudinal.

2. Gestión del cableado: El cable sale directamente del sistema de electrificación, y pasa a través de la base.

3. Salida del cableado: La salida del cable se realiza directamente desde el propio sistema de conexiones hasta el interior de la base de polietileno quedando oculto hasta llegar al suelo.

PS0715

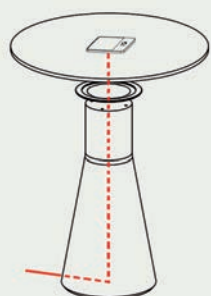
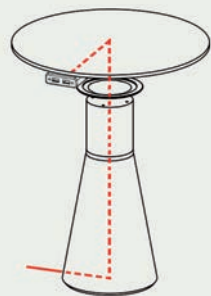

PS0716
PS0717

PS0718

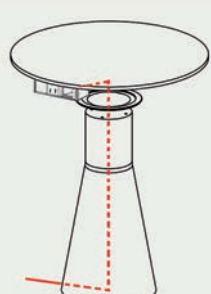
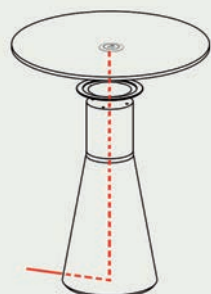

PS0754

Wire management / Conectividad

America

Under top Under top



Under table top USB charging system

Composed of 2 USB charging, black or white. It is composed of two USB charging ports.

Sistema de USB de carga bajo el sobre

Compuesto por 2 USB de carga. Está disponible en dos acabados, negro y blanco.

PS0715



In surface In surface



USB charging system

Composed of 2 USB charging. It is available in two finishes, black and white.

Sistema de carga USB

Compuesto por 2 USB de carga. Está disponible en dos acabados, negro y blanco.

PS0718

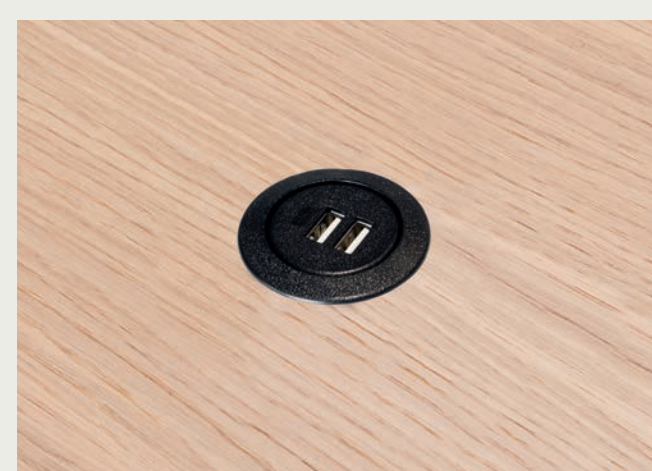

In surface In surface



Qi charging system

Composed of a large surface for charging by induction, 1 power + 1USB charging (PS 0716) or 2USB charging (PS 0717). It is available in two finishes, black and white.

Sistema de carga Qi

Compuesto por una amplia superficie para cargar por inducción, 1 power+ 1USB de carga (PS 0716) o 2 USB de carga (PS 0717). Está disponible en dos acabados, negro y blanco.

PS0716 / PS0717



Under top Under top



Sistema de USB de carga bajo el sobre

Composed by a profile, in two finishes, black or white. It is offered in 1 + 1, consisting of 1 power and the remaining configurable with minijack and USB, VGA, HDMI and USB, 2 USB data, 2 RJ45 or 2 USB charging.

Sistema de USB de carga bajo el sobre

Compuesto por un perfil, en dos acabados, negro o blanco. Se ofrece en 1+1, compuesto por 1 power y el restante configurable con minijack y USB, VGA, HDMI and USB, 2 USB de datos, 2 RJ45 o 2 USB de carga.

PS0754



Wire management / Conectividad

Europe

Distribution
Distribución

1. Power boxes distribution: By standard, the power/data box would be offset relative to the base. For tables with more than one power box, these will be separated 1/3 between them and placed horizontally and longitudinally.

2. Wire management: The cable passes through an aluminum wire manager, keeping it hidden from the users.

3. Wiring exit: the cable exits directly from the power system or through an aluminum frame so that it is concealed at the bottom of the base. The cable then crosses the aluminum profiles of the legs and is completely hidden until it reaches the floor.

1. Distribución de sistemas: De serie, el sistema de conexiones se dispondrá en el centro de la mesa. Para las mesas con más de un sistema, estos se colocarán con una separación de 1/3 de la longitud total de la mesa y en sentido longitudinal.

2. Gestión del cableado: El cable sale directamente del sistema de electrificación, permaneciendo invisible al usuario.

3. Salida del cableado: La salida del cable se realiza directamente desde el propio sistema de conexiones hasta el interior de la base de polietileno quedando oculto hasta llegar al suelo.

PS0715

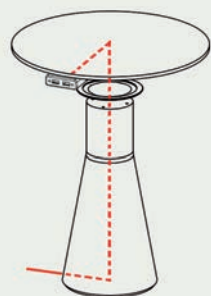

PS0714

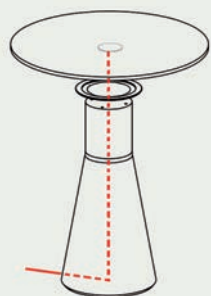

PS0718

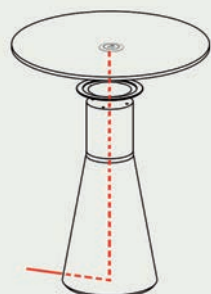

PS0786

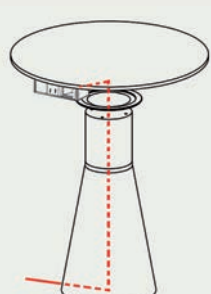

Wire management / Conectividad

Europe

Under top
Under top

Under table top USB charging system

Composed of 2 USB charging, black or white. It is composed of two USB charging ports.

Sistema de USB de carga bajo el sobre

Compuesto por 2 USB de carga. Está disponible en dos acabados, negro y blanco.

PS0715

In surface
In surface

USB charging system

Composed of 2 USB charging. It is available in two finishes, black and white.

Sistema de carga USB

Compuesto por 2 USB de carga. Está disponible en dos acabados, negro y blanco.

PS0718

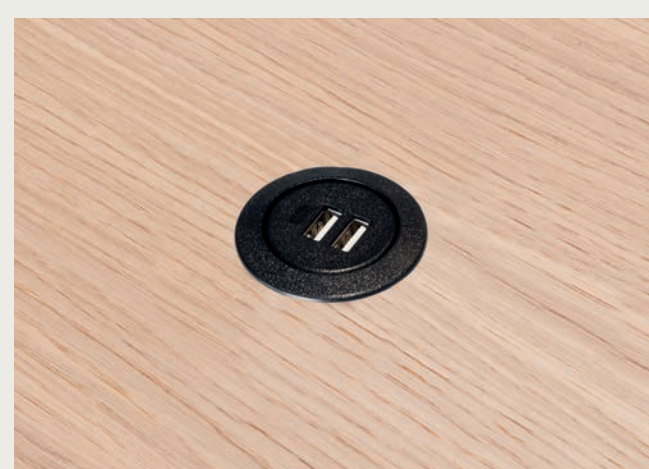
In surface
In surface

Qi charging system

Composed of a large surface for charging by induction. It is available in two finishes, black and white.

Sistema de carga Qi

Compuesto por una amplia superficie para cargar por inducción. Está disponible en dos acabados, negro y blanco.

PS0714

Under top
Under top

Sistema de USB de carga bajo el sobre

Composed by a profile, in two finishes, black or white. It is offered in 1 + 1, consisting of 1 power and the remaining configurable with minijack and USB, VGA, HDMI and USB, 2 USB data, 2 RJ45 or 2 USB charging.

Sistema de USB de carga bajo el sobre

Compuesto por un perfil, en dos acabados, negro o blanco. Se ofrece en 1+1, compuesto por 1 power y el restante configurable con minijack y USB, VGA, HDMI and USB, 2 USB de datos, 2 RJ45 o 2 USB de carga.

PS0786



Its characteristic oval steel frame appears on the surface of the table top as an element of marquetry, a detail reminiscent of the manufacturing of cabinet tables, and that connects with our experience in woodworking and noble materials. Light and very practical, they are characterized by their dual level frame.

Su característico marco oval de acero aparece en la superficie de las mesas como un elemento de marquetería, un detalle que recuerda a la fabricación de las mesas de gabinete, y que entronca con nuestra experiencia en el trabajo de la madera y los materiales nobles. Ligeras y muy prácticas, se caracterizan por su estructura en dos pisos.

Ruta Table

by PearsonLloyd



▼ **ME1927**

Occasional table with 4-legged steel tube base. Round table tops finished in lacquer, and gray glass.
Mesa auxiliar con base de 4 patas de tubo de acero. Sobres redondos acabado lacado y cristal fume gris.

▼ **ME1945**

Occasional table with 4-legged steel tube base. Round table tops finished in marble bamboo, and gray glass.

Mesa auxiliar con base de 4 patas de tubo de acero. Sobres redondos acabado mármol bambú y cristal fume gris.

▼ **ME1992**

Occasional table with 4-legged steel tube base. Round table tops finished in marble carrara, and gray glass.

Mesa auxiliar con base de 4 patas de tubo de acero. Sobres redondos acabado mármol carrara y cristal fume gris.

▼ **ME1902**

Occasional table with 4-legged steel tube base. Round table tops finished in lacquer, and gray glass.
Mesa auxiliar con base de 4 patas de tubo de acero. Sobres redondos acabado lacado y cristal fume gris.

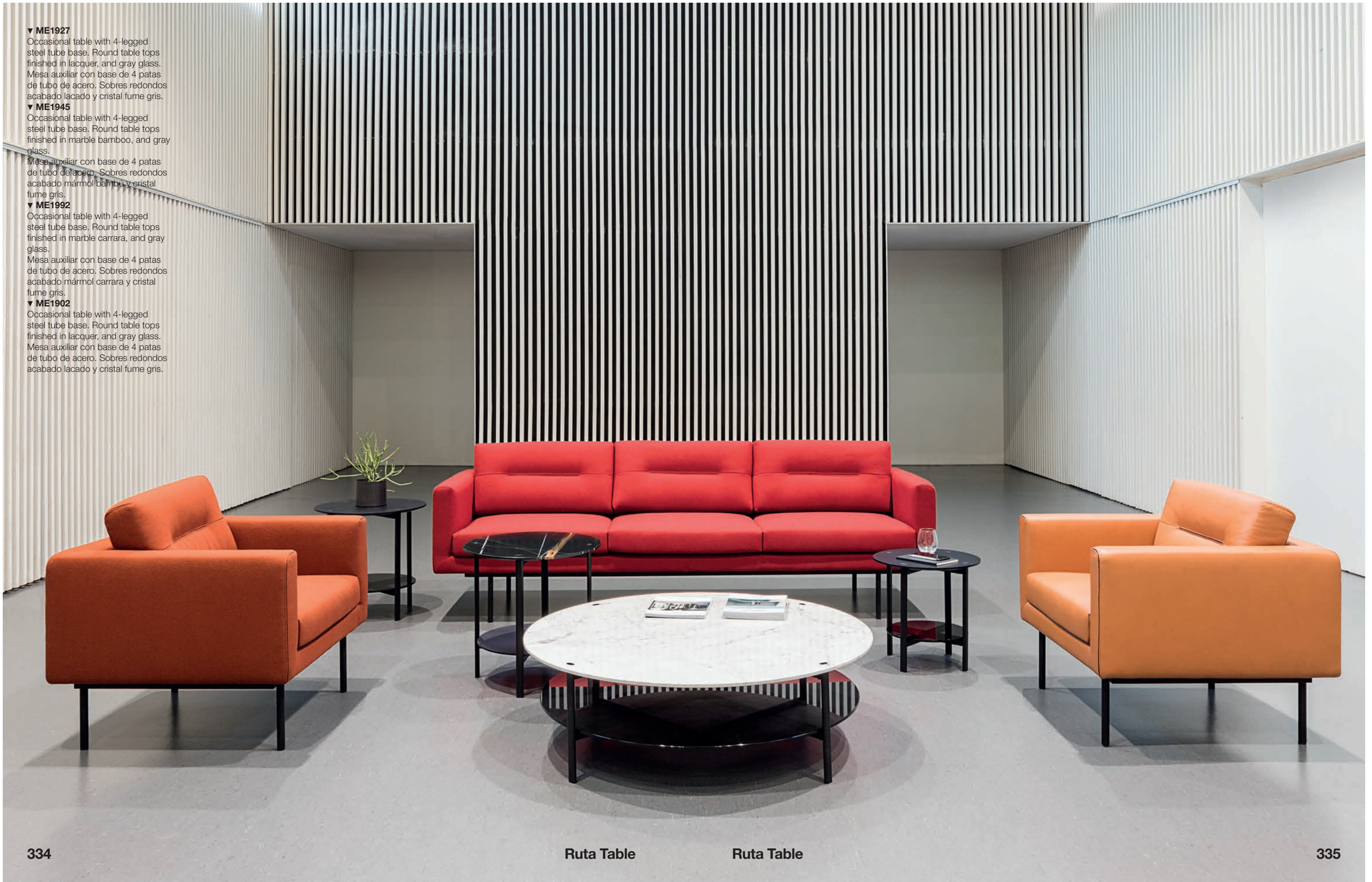

Occasional tables / Mesas auxiliares

Occasional table with 4-legged steel tube base finished in polished chrome, white or black. Round table tops in different sizes finished in oak, lacquer, smoked gray glass, Carrara marble and black marble bamboo.

Mesa auxiliar con base de 4 patas de tubo de acero y acabado cromo brillo, blanco o negro. Disponible en 2 alturas. Sobres redondos de diferentes medidas y acabado roble, lacado, cristal Fume gris, mármol Carrara y mármol negro bambú.

Oak Roble

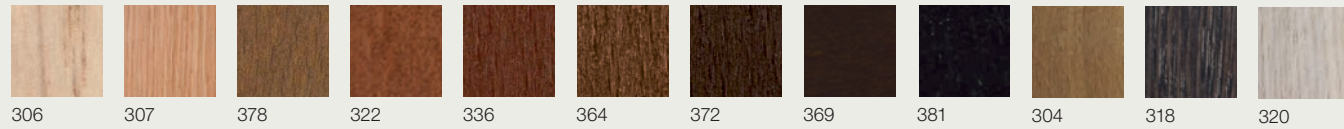

Premium finishes and wood lacquers Acabados premium y lacados

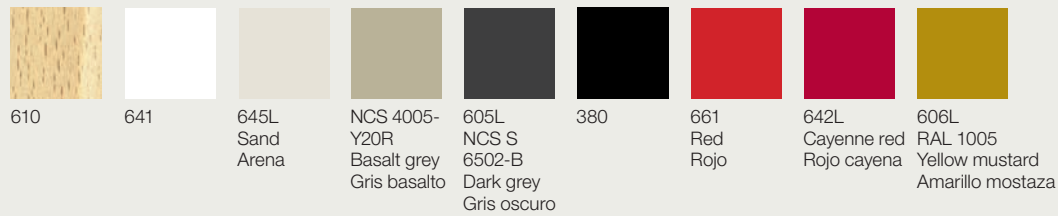

Steel Acero

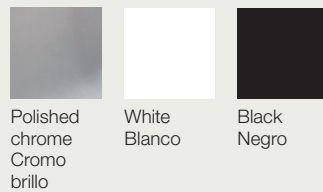

Marble Mármol

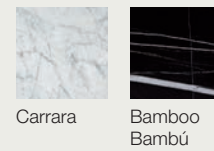

Glass Cristal

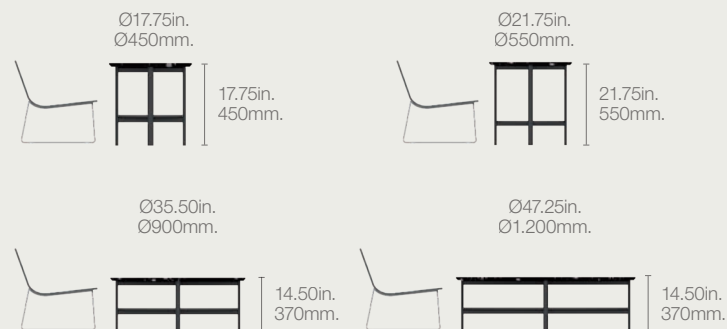

Sobres de mesa / Table tops

Top 18

18 mm./0.75in. top.
Sobre de mesa de 18mm./0.75in. de espesor con canto biselado.

Finishes / acabados

Oak / Roble
Lacquered / Lacado



Top Glass 10

10mm./0.4in. thick tempered glass. Optical glass version available. Suitable for outdoor use. The total thickness of table top is 10mm. glass + 12mm./0.5in. compact HPL.
10mm./0.4in. Vidrio templado. Versión de cristal óptico disponible. Adecuado para uso en exteriores. El grosor total de la mesa es de 10 mm. vidrio + 12mm./0.5in. Compacto HPL.



Top 20 Marble Razor

20mm/0.80in. marble table top with bevelled edge.
Sobre de mesa de mármol de 20mm/0.80in. de espesor con canto biselado



Top 20 Marble Square

20mm/0.80in. marble table top.
Sobre de mesa de mármol de 20mm/0.80in. de espesor



An occasional table can also be very iconic. Uves Occasional expresses the nobility of solid wood with a contained, elegant design. The two base heights increase the versatility of this exemplary table.

Una mesa auxiliar también puede resultar muy representativa. Uves Occasional expresa la nobleza de la madera maciza en un diseño contenido y elegante. Sus dos alturas de base diferentes aumentan la versatilidad de esta mesa emblemática.

Uves Occasional

by Lievore Altherr Molina



► **ME3697 Uves Ocasional**

► **ME3686 Uves**

Occasional table made of solid oak base and top.

Mesa ocasional con sobre base de madera de roble.

▼ **ME3686 Uves**

▼ **ME3697 Uves Ocasional**

► **ME3686 Uves**

► **ME3697 Uves Ocasional**

Occasional table made of solid oak base and top.

Mesa ocasional con sobre base de madera de roble.



Occasional tables / Mesas auxiliares

Occasional tables made of solid oak base and top. Available in two different height and 4 different top dimensions.

Mesa auxiliar con sobre y base de madera de roble. Disponible en 2 alturas y 4 medidas de sobre.

Oak Roble

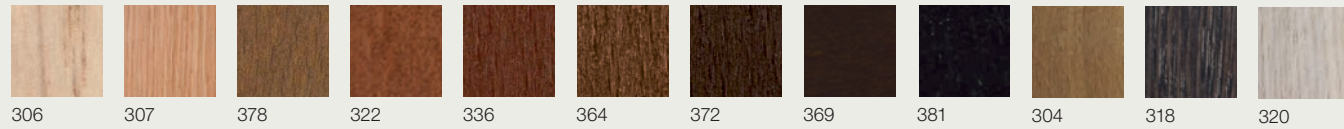

Premium finishes and wood lacquers Acabados premium y lacados



Occasional tables / Mesas auxiliares

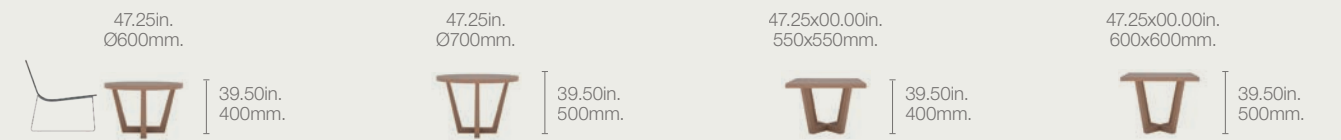

The possibilities of the Top Collection are so vast that they can satisfy any interior design need. The traditional square and circular shapes are complemented by an elliptical design developed by carefully combining four different ellipses in a single gesture. They include materials of great resistance and high durability suitable to give solutions to different surfaces of tables as workspaces, hospitality or residential.

Las colecciones Top son tan extensas que pueden satisfacer cualquier necesidad en el ámbito del diseño de interiores. A las formas tradicionales, cuadrada y circular, se suma también la elíptica. Incluyen materiales de gran resistencia y alta durabilidad idóneo para dar soluciones a diferentes superficies de mesas como zonas de trabajo, instalación o residencial.

Tops

by Estudio Andreu



Top Technical stone



346

Top

Top Technical stone

3mm./0.15in ceramic top + 5mm./0.2in glass board. Colors: brown earth, sand gray, stone gray. Valid for any central column collection. Suitable for outdoor use.

Tablero de mesa compuesto por una cubierta cerámica de 3mm./0.15in. + tablero de vidrio de 5mm./0.2in. Colores: Marrón tierra, Gris arena, Gris piedra. Válido para cualquier colección de columna central. Válido para su uso en exterior.

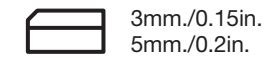

Technical Stone Finish

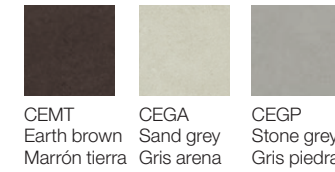

Certifications Certificaciones

European Standard
UNE EN 13501:1-2

International Standards
UNE EN ISO 10545-3
UNE EN ISO 10545-4
UNE EN ISO 10545-6
UNE ENV 12633
UNE EN ISO 10545-12
UNE EN ISO 10545-9.

Suitable for tables: Válido para las mesas:

Extra Table
Dual Occasional
Quattro Occasional
Raglan Table
Reverse Occasional

Suitable for bases: Válido para las bases:

Colors
Dual
Plaza
Quattro
Reverse

Shapes

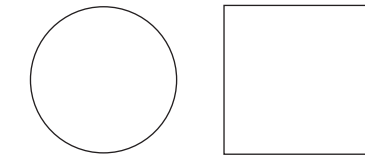

Top

347

Top Compacto HPL



Top Compacto HPL

Table top composed of a center compact high pressure laminate (HPL), 12mm./0.50in. thickness. Colors: Black N201 and White B200. Suitable for any central column base. Valid for outdoor and intensive use areas.

Tablero de mesa compuesto por un laminado de alta presión de centro compacto (HPL), de 12mm./0.50in. Colores: Negro N201 y Blanco B200. Válido para cualquier base de columna central. Válido para exterior y áreas de uso intenso.



Top Compacto HPL Finish

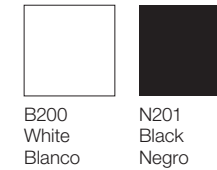

Certifications Certificaciones

European Standard
UNE EN 13501:1-2

EN 438-2-4, EN 438-2-5, EN 438-2-6, EN 438-2-7, EN 438-2-8,
EN 438-2-9, EN 438-2-10, EN 438-2-12, EN 438-2-14,
EN 438-2-16, EN 12721, EN 438-2-17, EN 438-2-21,
EN 438-2-24, EN 438-2-25, EN 438-2-26, EN 438-2-27,
EN 438-2-30, EN ISO 1183-1, ISO 178: 2003, ISO R527: 1996.

Suitable for tables: Válido para las mesas:

Extra Table
Dual Occasional
Nuez Table
Nuez Occasional
Quattro Occasional
Raglan Table
Reverse Occasional

Suitable for bases: Válido para las bases:

Colors
Dual
Plaza
Quattro
Reverse

Shapes





18mm./0.75in. plywood table top with beveled edge. Suitable for any central column base.

Tablero de mesa contrachapado de 18mm./0.75in. con canto biselado. Válido para cualquier base de columna central.

Oak
Roble



18mm./0.75in.

Oak
Roble



Linoleum
Linóleo

Laminate
Laminado



Ultra-matte
Ultramate

Premium finishes and wood lacquers
Acabados premium y lacados



Shapes

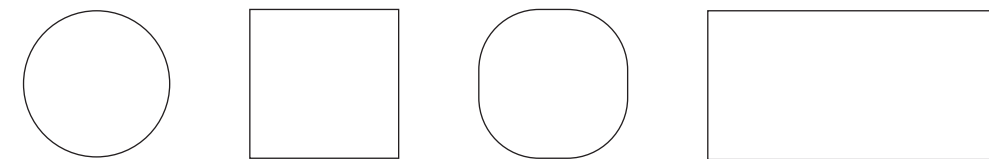

Suitable for tables:
Válido para las mesas:

Extra Table
Dual Occasional
Quattro Occasional
Raglan Table
Reverse Occasional
Couvé Table
Ruta Table

Suitable for bases:
Válido para las bases:

Colors
Dual
Plaza
Quattro
Reverse

Certifications
Certificaciones

European Standard
UNE EN 13501:1-2

EN 438-2-4, EN 438-2-5, EN 438-2-6, EN 438-2-7, EN 438-2-8,
EN 438-2-9, EN 438-2-10, EN 438-2-12, EN 438-2-14,
EN 438-2-16, EN 12721, EN 438-2-17, EN 438-2-21,
EN 438-2-24, EN 438-2-25, EN 438-2-26, EN 438-2-27,
EN 438-2-30, EN ISO 1183-1, ISO 178: 2003, ISO R527: 1996.



Top 23

23mm./0.90in. double-sided maple veneered table top and curved edge. Suitable for any central column collection.

Tablero de mesa chapado en arce a dos caras de 23mm./0.90in. y canto curvo Válidos para cualquier colección de columna central.



Maple
Arce

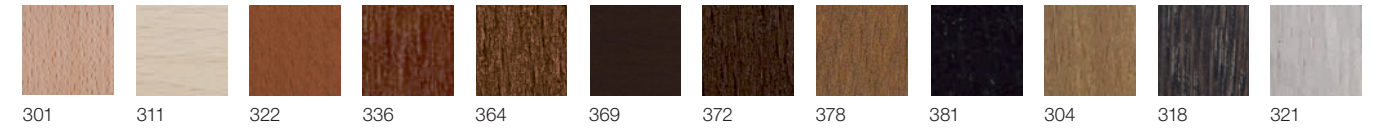

Premium finishes and wood lacquers
Acabados premium y lacados

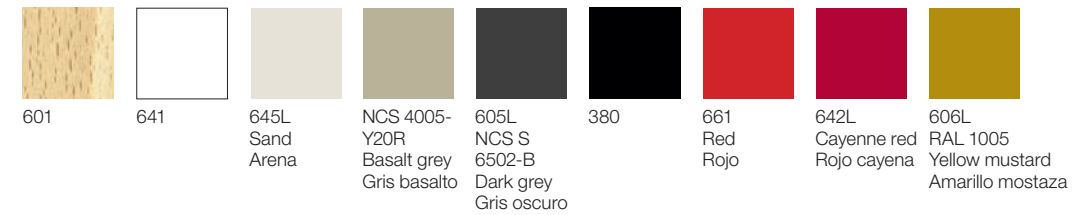

Linoleum
Linóleo



Ultra-matte
Ultramate

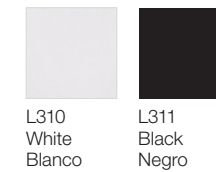

Shapes

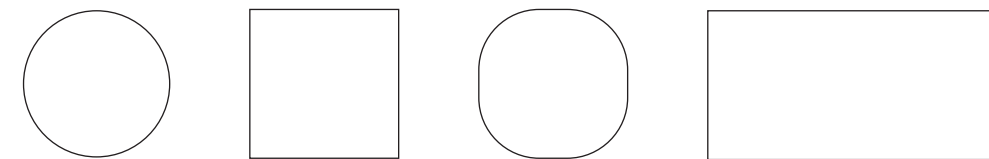

Suitable for bases:
Válido para las bases:

Colors
Dual
Plaza
Quattro
Reverse

Certifications
Certificaciones

European Standard
UNE EN 13501:1-2

EN 438-2-4, EN 438-2-5, EN 438-2-6, EN 438-2-7, EN 438-2-8, EN 438-2-9, EN 438-2-10, EN 438-2-12, EN 438-2-14, EN 438-2-16, EN 12721, EN 438-2-17, EN 438-2-21, EN 438-2-24, EN 438-2-25, EN 438-2-26, EN 438-2-27, EN 438-2-30, EN ISO 1183-1, ISO 178: 2003, ISO R527: 1996.

Top 30 Square



Top 30 Square

30mm./1.20in. thick laminated table top available in different finishes. Suitable for any central column base.

Tablero de mesa laminado de 30mm./1.20in. de espesor disponible en diferentes acabados. Válido para cualquier base de columna central.



Laminate Laminado

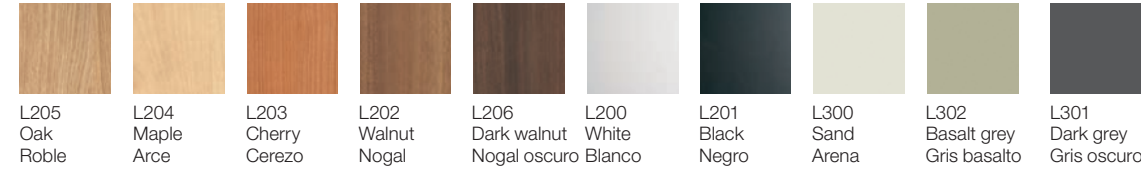

Ultra-matte Ultramate

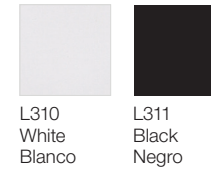

Shapes

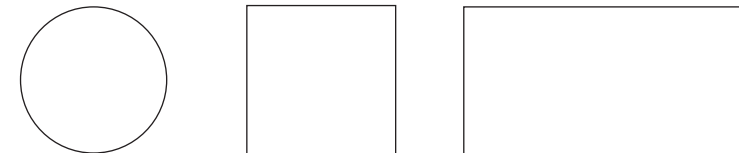

Suitable for bases: Válido para las bases:

Colors
Dual
Plaza
Quattro
Reverse

Certifications Certificaciones

European Standard
UNE EN 13501:1-2

EN 438-2-4, EN 438-2-5, EN 438-2-6, EN 438-2-7, EN 438-2-8,
EN 438-2-9, EN 438-2-10, EN 438-2-12, EN 438-2-14,
EN 438-2-16, EN 12721, EN 438-2-17, EN 438-2-21,
EN 438-2-24, EN 438-2-25, EN 438-2-26, EN 438-2-27,
EN 438-2-30, EN ISO 1183-1, ISO 178: 2003, ISO R527: 1996.



Top SP 40

40mm./1.50in. maple table top with solid edges. Suitable for any central column collection.

Sobres de arce de 40mm./1.50in. con cantos macizos. Válido para cualquier colección de columna central.

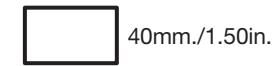

Maple
Arce

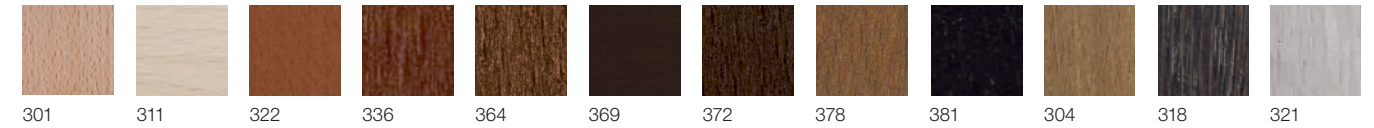

Linoleum
Linóleo

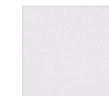

L315
Ivory
Marfil



L316
Black
Negro



L205
Oak
Roble



L204
Maple
Arce



L203
Cherry
Cerezo



L202
Walnut
Nogal



L206
Dark walnut
Nogal oscuro



L200
White
Blanco



L201
Black
Negro



L300
Sand
Arena



L302
Basalt grey
Gris basalto



L301
Dark grey
Gris oscuro

Ultra-matte
Ultramate

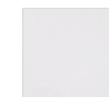

L310
White
Blanco



L311
Black
Negro



610

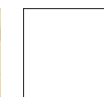

641



645L
Sand
Arena



NCS 4005-
Y20R
Basalt grey
Gris basalto



605L
NCS S
6502-B
Dark grey
Gris oscuro



380



661
Red
Rojo



642L
Cayenne red
Rojo cayena



606L
RAL 1005
Yellow mustard
Amarillo mostaza

Shapes

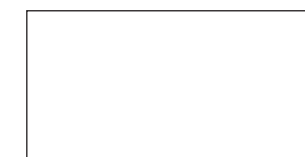
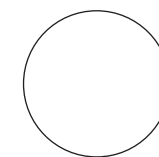

Suitable for tables:
Válido para las mesas:

Sistema SP

Suitable for bases:
Válido para las bases:

Colors
Dual
Plaza
Quattro
Reverse

Certifications
Certificaciones

European Standard
UNE EN 13501:1-2

EN 438-2-4, EN 438-2-5, EN 438-2-6, EN 438-2-7, EN 438-2-8,
EN 438-2-9, EN 438-2-10, EN 438-2-12, EN 438-2-14,
EN 438-2-16, EN 12721, EN 438-2-17, EN 438-2-21,
EN 438-2-24, EN 438-2-25, EN 438-2-26, EN 438-2-27,
EN 438-2-30, EN ISO 1183-1, ISO 178: 2003, ISO R527: 1996.



Top Glass 10

10mm./0.40in. tempered glass table top, available in optical glass version. The total thickness of the table is 10mm./0.40in. glass + 12mm./0.50in. compact HPL. Suitable for any central column collection. Valid for outdoor use.

Tablero de mesa de vidrio templado de 10mm./0.40in., con versión de cristal óptico disponible. El grosor total de la mesa es de 10mm./0.40in.vidrio + 12mm./0.50in. Compacto HLP. Válido para cualquier colección de columna central. Válido para su uso en exterior.



**Glass finish
Acabados cristal**

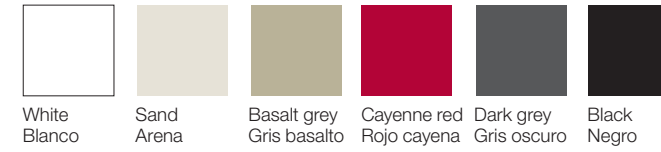

Shapes

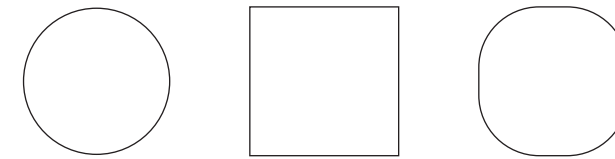

**Certifications
Certificaciones**

European Standard
UNE EN 13501:1-2

EN 438-2-4, EN 438-2-5, EN 438-2-6, EN 438-2-7, EN 438-2-8,
EN 438-2-9, EN 438-2-10, EN 438-2-12, EN 438-2-14,
EN 438-2-16, EN 12721, EN 438-2-17, EN 438-2-21,
EN 438-2-24, EN 438-2-25, EN 438-2-26, EN 438-2-27,
EN 438-2-30, EN ISO 1183-1, ISO 178: 2003, ISO R527: 1996.

**Suitable for tables:
Válido para las mesas:**

Extra Table
Ruta Table

**Suitable for bases:
Válido para las bases:**

Colors
Dual
Plaza
Quattro
Reverse

Top solid surface



Top solid surface

12mm./0.50in. table top. Available in glacier white. Suitable for any column collection. Valid for outdoor use.

Tablero de mesa de 12mm./0.50in. Disponible en color blanco glaciar. Válido para cualquier colección de columnas. Válido para uso en exterior.



Finishes
Acabados

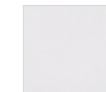

Glacier
white

Shapes

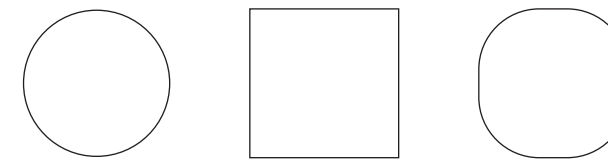

Certifications
Certificaciones

European Standard
UNE EN 13501

DIN ISO 1183, DIN EN ISO 178, EN ISO 604, DIN ISO 4586 T11, DIN ISO 4586 T12, DIN EN 101, DIN ISO 4586 T6, DIN ISO 4586 T7, DIN EN ISO 846, DIN 51130:1992-11, DIN ISO 4586 T10, DIN ISO 4586 T8, DIN ISO 4586 T16, DIN IEC 61 340-4-1.

Suitable for tables:
Válido para las mesas:

Dual Occasional
Nuez Occasional
Quattro Occasional
Raglan Table
Reverse Occasional

Suitable for bases:
Válido para las bases:

Colors
Dual
Plaza
Quattro
Reverse

Special thanks/Agradecimientos

<p>Zest Architecture zestarchitecture.com</p> <p>Mas que espacio masquespacio.com</p> <p>Sanahuja&Partners. Arquitectura Hatgallery.com</p> <p>ConSORCI per a la Normalització Lingüística (CPNL) http://www.cpnl.cat</p> <p>Viraje Arquitectura www.viraje.es</p> <p>CRP Ciutat Vella</p> <p>Vegamar Vegamarseleccion.es</p> <p>Restaurante Malmö www.restaurantemalmo.com</p> <p>Francisco Mangado www.fmangado.es</p> <p>Fundació Pascual Maragall (Barcelona) Architecture project / Proyecto de arquitectura: Juan Navarro Baldeweg</p> <p>Carmen Baselga_Taller de proyectos Photography / Fotografía: Héctor Rubio</p> <p>Edificio Emergencias 112 (Reus) Architecture project / Proyecto de arquitectura: ACXT Arquitectos</p> <p>Biblioteca Sant Josep (Ontinyent) Architecture project / Proyecto de arquitectura: Ramón Esteve</p> <p>MUJI (Barcelona) www.muji.es/shop</p> <p>Estudio Lavernia & Cienfuegos (Valencia) Architecture project and interior design studio / Proyecto de arquitectura e interiorismo: Nacho Lavernia y Alberto Cienfuegos</p>	<p>Academia 2Day Languages Valencias www-2daylanguages.com</p> <p>Alfons Tost (Accions Interiorisme) www.accionbcn.com Proyectos de interiorismo / Interior Design projects: Monvinic, Accions</p> <p>Bd ediciones (Girona)</p> <p>Showroom EHD</p> <p>Laura Alandes Interior Design project / Proyecto de Interiorismo: Ma Khin Cafe</p> <p>Fran Silvestre Arquitectos www.fransilvestrearquitectos.com</p> <p>Francesc Rifé Proyectos de interiorismo / Interior Design projects: Indret Advocats, Iglesias Joiers, Residencia Primer Equipo Real Madrid, Caixa A-Diagonal Barcelona, Casa Olivella, Bodegas El Cep, Duravit, Restaurante Nuba, Apartamento EJ</p> <p>Biblioteca Montilivi (Universitat de Girona)</p> <p>E/1:1 Mónica Tárrega Klein www.escalaunouno.com Proyectos de interiorismo / Interior Design projects: Vivienda Escorial</p> <p>Auditorio Teulada-Moraira (Alicante) Proyectos de arquitectura / Architecture project: Francisco Mangado</p> <p>Conselleria de Sanitat (Valencia) Dirección General de Salud Pública</p> <p>Silvestre Navarro Arquitectos Proyecto / Project: Casa para un carpintero www.silvestrenavarro.com</p> <p>Office EG Neerpelt Proyectos de interiorismo / Interior Design projects: Lens Ass Architecten www.lensass.be</p>	<p>Gunni&Trentino (Barcelona)</p> <p>Espai Caixa Girona</p> <p>Gallardo Llopis Arquitectos www.gallardo-llopis.com</p> <p>Bodegas Ferrer Bobet. Priorat www.ferrerbobet.com</p> <p>Banc Sabadell. Sant Cugat del Vallés</p> <p>Hotel Aire de Bardenas Tudena (Navarra)</p> <p>Ma Khin Café Mercado de Colón (Valencia)</p> <p>Carlos Ferrater Arquitectura www.ferrater.com</p> <p>Caro Hotel www.carohotel.com</p> <p>Restaurante La Turqueta (Grupo Saona) www.gruposadona.com</p> <p>Autis Ingenieros www.autis.es</p> <p>Restaurante Dos Paillos www.dospaillos.com</p> <p>Restaurante Hikari Yakitori www.hikariyakitoribar.es</p> <p>Ricard Camarena Bar Bombas Gens Centre D'Art www.ricardcamarena.com</p> <p>Centre cívic de Ferreries</p> <p>Wayco Coworking www.wayco.es</p> <p>Veles e vents www.veleseventsvalencia.es</p>
--	--	--

Designers/Diseñadores

Patricia Urquiola
Lievore Altherr Molina
Piergiorgio Cazzaniga
Manel Molina
PearsonLloyd
Estudio Andreu
Gensler

Photography/Fotografía

Gerald Kiernan
Estudio Andreu
Eugeni Pons
Salva López
José Hevia Blach
Robert Holden
Enok Holsegard
Xavier Molla
Fernando Alda
Bieke Claessens
Jorg Brauer
Fernando Guerra
Sergio Guerra

Graphic project/Proyecto gráfico

Antonio Solaz

Addresses/Direcciones

<p>Andreu World Showroom Valencia (Spain) &Head Office Phone +34 96 180 57 00 valencia@andreuworld.com</p> <p>Showroom Madrid (Spain) Phone +34 96 180 57 00 madrid@andreuworld.com</p> <p>Showroom Chicago (USA) &Head Office Phone 312 464 0900 chicago@andreuworld.com</p> <p>Showroom New York (USA) Phone 312 464 0900 newyork@andreuworld.com</p> <p>Showroom Washington (USA) Phone 312 464 0900 washingtondc@andreuworld.com</p> <p>Showroom San Francisco (USA) Phone 312 464 0900 sanfrancisco@andreuworld.com</p> <p>Showroom Boston (USA) Phone 312 464 0900 boston@andreuworld.com</p> <p>Showroom Denver (USA) Phone 312 464 0900 denver@andreuworld.com</p> <p>Showroom Mexico Phone +52 1 998 154 3511 mexicocity@andreuworld.com</p>	<p>Showroom Andreu World London London (UK) Phone 44 1576 330005 london@andreuworld.com</p> <p>Showroom Andreu World Paris Paris paris@andreuworld.com</p> <p>Showroom & Office Andreu World Pacific Japan Phone +81 3 6804 2966 tokyo@andreuworld.com</p> <p>Showroom & Office Andreu World Karpatia Ukraine Phone +380.3131.54070 info@andreuworld.com</p> <p>Showroom Andreu World Dubai Dubai dubai@andreuworld.com</p> <p>Showroom Andreu World India New Delhi (India) Phone +91 971 173 3808 newdelhi@andreuworld.com</p> <p>Showroom Pune (India) Phone +91 202 616 1644 pune@andreuworld.com</p> <p>Showroom Bangalore (India) Phone +91 98 86 653005 bangalore@andreuworld.com</p> <p>Showroom Gurgaon (India) Phone +91-9711733808 gurgaon@andreuworld.com</p>
--	---

The paper used to produce this catalog comes from responsibly managed forests and other controlled sources for greater environmental protection.

El papel utilizado para producir este catálogo proviene de bosques gestionados de forma responsable y de otras fuentes controladas que garantizan la protección del medio ambiente.

Andreu World S.A.
Copyright©AndreuWorld,
6 / 2020

Printed in Spain

Esta publicación no puede ser reproducida en todo o en parte sin el permiso escrito del editor. Todos los modelos están protegidos mediante patente internacional.

This publication may not be reproduced in whole or in part in any manner whatsoever without the written permission of the publisher. All models are protected by international patent.

