

prost

collections
kolekcije

oria 20

21

match
cloud
absent
layout
combine
impression
convert
segment
seam
revolve
up-lift
pil-low
bavul
fade
combo
shtef
knif
kontrapunkt
polygon
monk
tinker
rhomb



german
brand
award
21
winner

prostoria 2021



sofas, sofasbeds, accessories	garniture, garniture na razvlačenje, dodaci	6
	match	8
	cloud	20
	absent	30
	layout	40
	combine	50
	impression	58
	convert	64
	segment	72
	seam	78
	revolve	84
	up-lift	90
	pillow	96
	bavul	102
	fade	108
	combo	114
	shtef	120
	knif	130

chairs, easy chairs, tables, small tables	stolice, naslonjači, stolovi, stolići	138
	kontrapunkt	140
	polygon	146
	monk	156
	tinker	172
	rhomb	180
	strain	190
	oblique	200
	oblikant	208
	piun	216
	trifidae	222
	dobra	230
	bik	238
	3angle	244
outdoor furniture	namještaj za eksterijer	252
	umomoku, osmo, coo coo, jugo, polygon, oblique, strain	254
designers	dizajneri	280

sofas
sofabeds
accessories



garniture
garniture na
razvlačenje
dodaci



match



Match is a modular sofa providing a welcoming space and experience of comfort. Its design features basic lines of a somewhat lower backrest and an elevated armrest, while the cold foam fills its volume with sufficient firmness for comfortable seating. The cover made of natural materials enhances the experience of relaxation. Match's dimensions go hand-in-hand with the needs of diverse groups of users who can choose between two different widths and depths of the module.

Design: Sanja Knezović

Match je modularna sofa koja pruža iskustvo udobnosti i ugodne zone za druženje. Njezin dizajn definiran je minimalističkim linijama nešto nižeg naslona i povišenih rukonaslona, dok hladna pjena ispunjava sam volumen stvarajući čvrstoću dostatnu za ugodno sjedenje i odmaranje. Oblačenje u tkanine prirodnog podrijetla dodatno podržava opuštanje i ugodu. Dimenzije Matcha idu ukorak s potrebama različitih grupa korisnika koji mogu birati između dviju različitih širina i dubina modula.



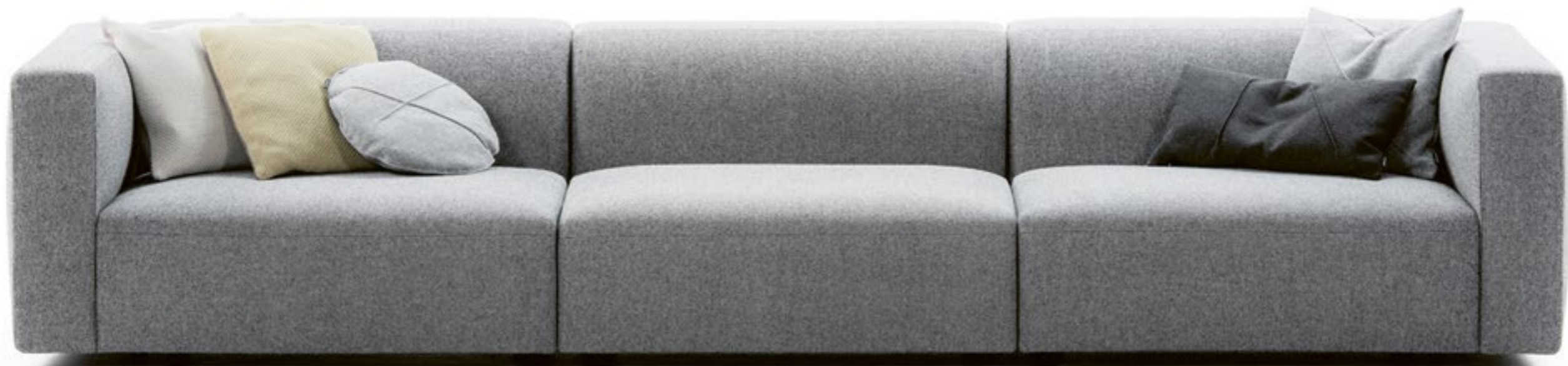





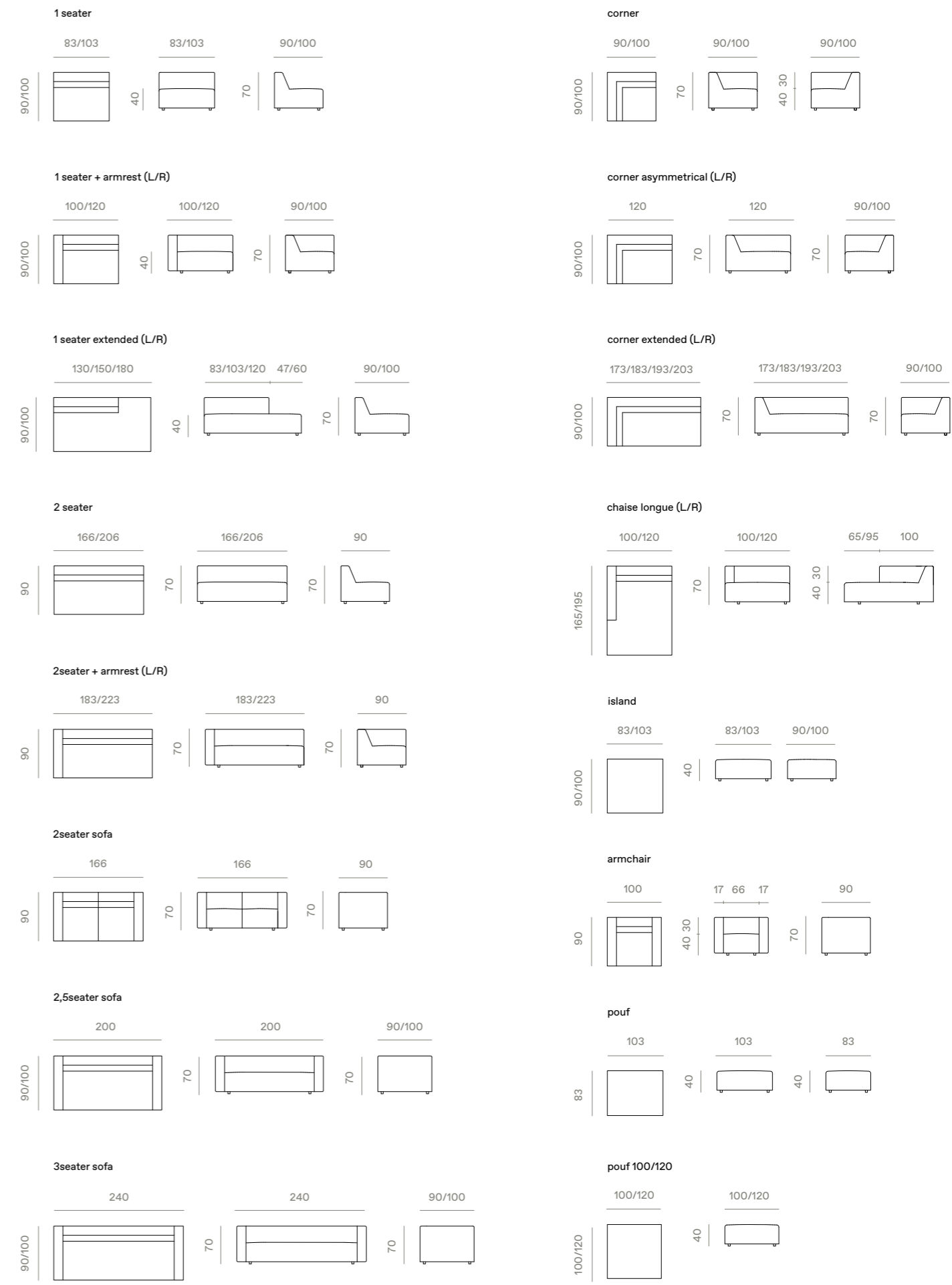

cloud



Cloud is a modular sofa providing an ultimate experience of comfort. Its minimalistic form of a somewhat lower backrest and an elevated armrest cover the support from the cold foam that reinforces its volume, while the superficial layer of feather filling adds extra softness and a sense of 'leisure in the clouds'. Its dimensions go hand-in-hand with the needs of diverse groups of users. Cloud's morphology is ideal for the furnishing of larger spaces.

Design: Sanja Knezović

Cloud je modularna sofa dizajnirana za vrhunski doživljaj udobnosti. Njezina je forma definirana minimalističkim linijama nešto nižeg naslona i povišenim rukonaslonom. Unutrašnja potpora od hladne pjene učvršćuje i kreira volumen, dok poseban površinski sloj punjenja perjem izgrađuje dodatnu mekoću i osjećaj odmora „kao u oblacima”. Zbog svoje morfologije Cloud je idealan za opremanje većih prostorija.





The Frameless collection is a member of the Frame family of low tables. The only difference between them is in the thickness of their metal construction. As the name suggests, Frameless appears as the ultimate light object thanks to its gracile slim metal construction. The table can be used to stand alone or arranged in a series in the given framework. The selected height is determined by its position as the main or side table. The frame is made of metal profile with glass or compact panel placed onto it.

Design: Sanja Knezović

Kolekcija Frameless pripada obitelji stolića Frame, a jedina razlika među njima je debljina metalne konstrukcije. Frameless je izrazito tanke konstrukcije zahvaljujući kojoj djeluje vrlo rafinirano, a može funkcionirati samostalno ili u grupi. Može se pozicionirati kao glavni stolić uz sjedeću garnituru ili kao stolić za priručno odlaganje predmeta. Visinu je jednostavno prilagoditi ovisno o položaju i namjeni. U tanki metalni okvir upuštene su plohe s kompaktnom jezgrom ili od stakla.





armchair

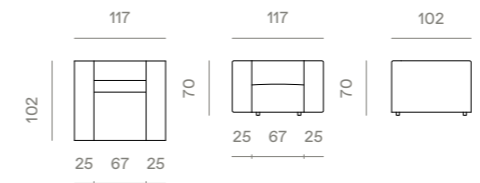

corner

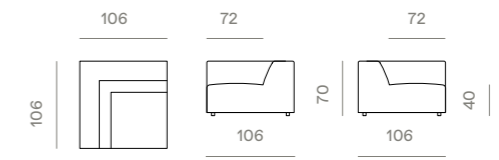

1seater 103

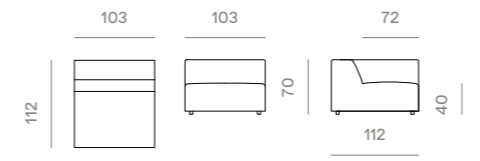

corner asymmetrical (L/R)

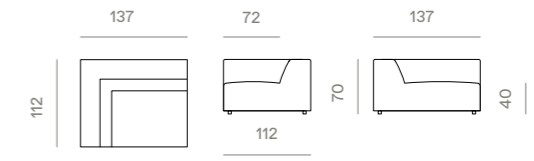

1seater+armrest (L/R) 103

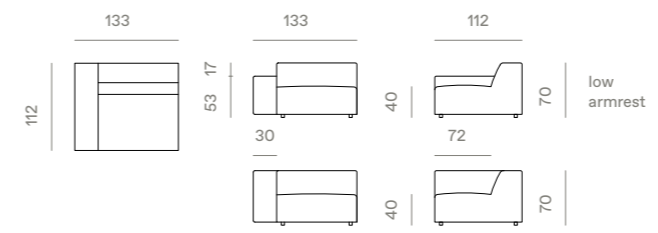

island

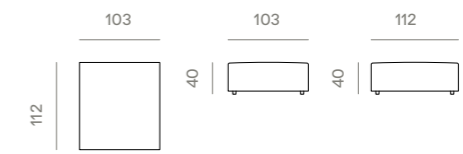

1seater extended (L/R) 153/183

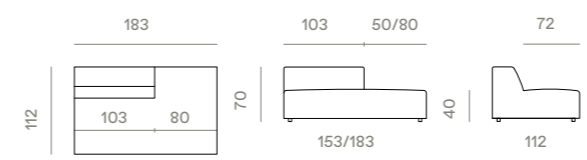

pouf

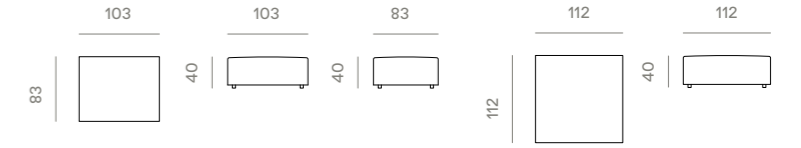

chaise longue (L/R) 177/207 / chaise longue SOLO (L/R) 177/207

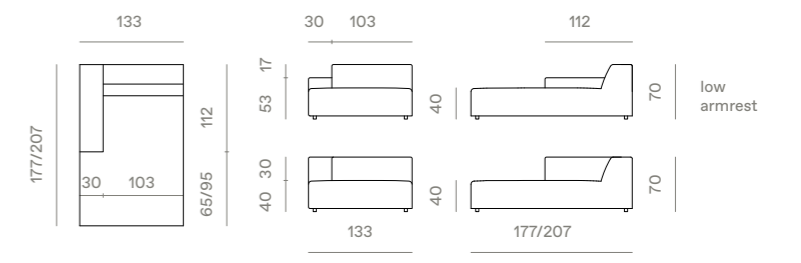

corner compositions

composition 1

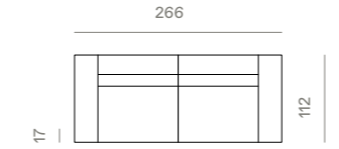

composition 2

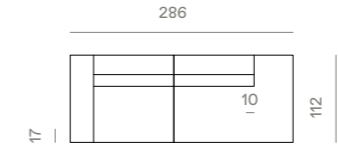

composition 3

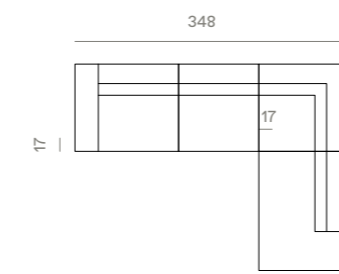

composition 4

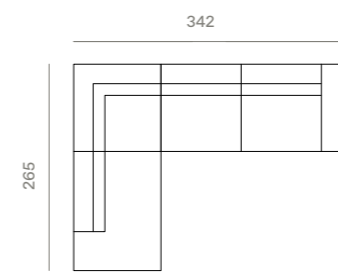

composition 5

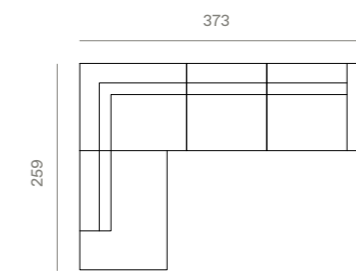

composition 6

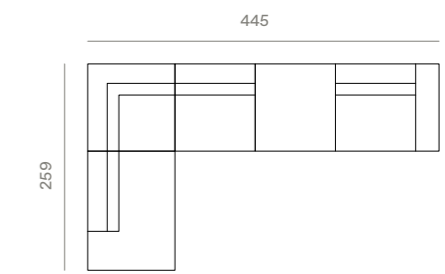

frame + frameless table 1/2

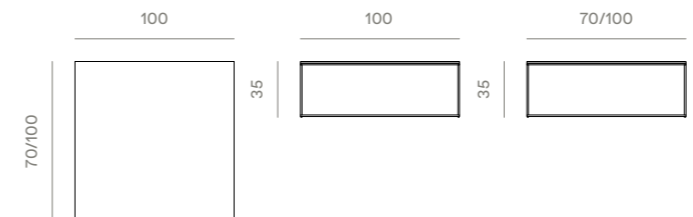

frame + frameless table 3/4

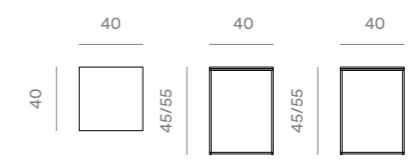

frame + frameless table 5/6

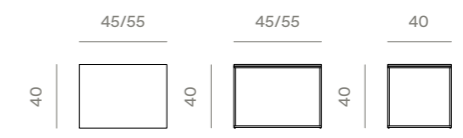

absent



Unfolding as a fluid organic shape, Absent is a sofa designed for a body position in-between sitting and lying down. Using cold foam compositions, the sofa's ergonomic design provides premium comfort and a fully customized lounging experience with a futuristic flair. This sofa system combines various backrest heights with different seat depths, while the soft pillow adds to its ergonomics and particular sensual experience. With Absent you can simply glide into a comfort zone, an inner dimension where you can feel weightless and safe.

Design: Numen / For Use

Absent je sofa dizajnirana za položaj tijela između sjedenja i ležanja što uz njezinu ergonomičnost pruža vrhunsku udobnost i doživljaj odmaranja s daškom futurizma. Ova modularna sofa kombinira različite visine naslona i različite dubine sjedala, dok mekani jastuk pridonosi ergonomiji i posebnom osjetilnom doživljaju. Dizajn Absenta omogućava da kliznete u zonu udobnosti, onu unutarnju bestežinsku dimenziju u kojoj se osjećate sigurni.









seat S + backrest high / backrest low

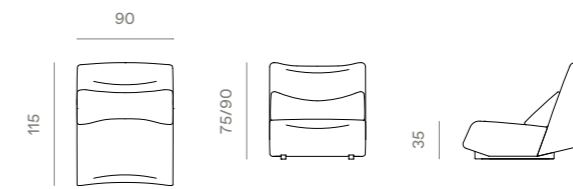

seat M + backrest high / backrest low

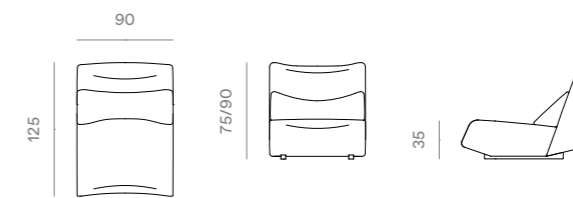

seat L + backrest high / backrest low

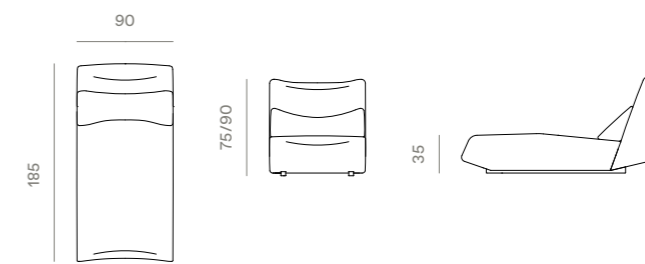

corner S low / corner M low

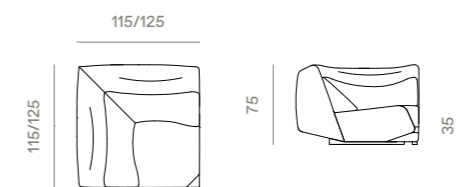

pouf

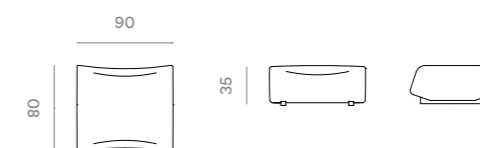

layout



The Layout modular sofa with its seamlessly interconnected seats and poufs, generates a soft terrain of sloping surfaces that are pliable for leisure and socializing at home. Its design also brings the ultimate comfort of a home sofa into an office environment, hotel lobby or airport lounge, offering a cocoon of privacy. Its design consists of 4 elements (a seater with backrest, two corners and a pouf) which offers functionality to build endless interior configurations.

Design: Numen / For Use

Dizajn modularne sofe Layout stvara mekani reljef nagibnih površina podobnih za odmaranje i socijalizaciju s prijateljima kod kuće. Istodobno donosi vrhunsku udobnost kućne sofe u uredsko okruženje, predvorje hotela ili salona u zračnoj luci, nudeći okrilje privatnosti. Sustav se sastoji od četiri osnovna elementa (naslonjača, dva kutna elementa i taburea) i omogućuje kreiranje beskrajnih konfiguracija u prostoru.





The design of Avet low table relies on the light triangular metal construction, whose skeletal lines endow it with certain fragility and weightlessness. With the addition of toned glass surface, the table becomes almost dematerialized, an elegant, shadowy silhouette.

Design: Numen / For Use

Osnova dizajna stolića Avet je lagana trokutna metalna konstrukcija čije tanke linije odišu krhkošću i lakoćom. Okvir gornje kvadratne ploče zarotiran je za 45 stupnjeva u odnosu na donju, manju bazu, čime nastaje zakrivljena, kristalna forma. Dodatkom zatamnjene staklene plohe stol se gotovo dematerijalizira i postaje elegantna silueta, što objašnjava i prikladno ime koje je dobio – Avet (što znači: duh ili fantom).



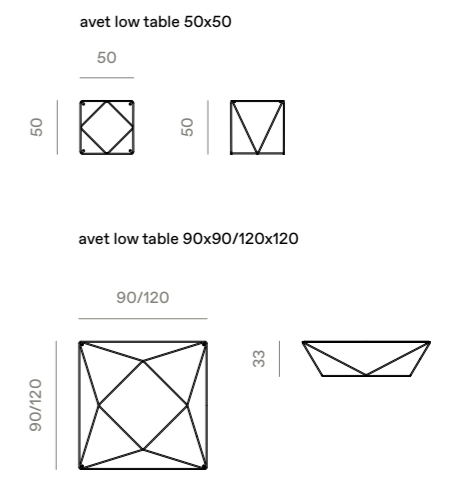
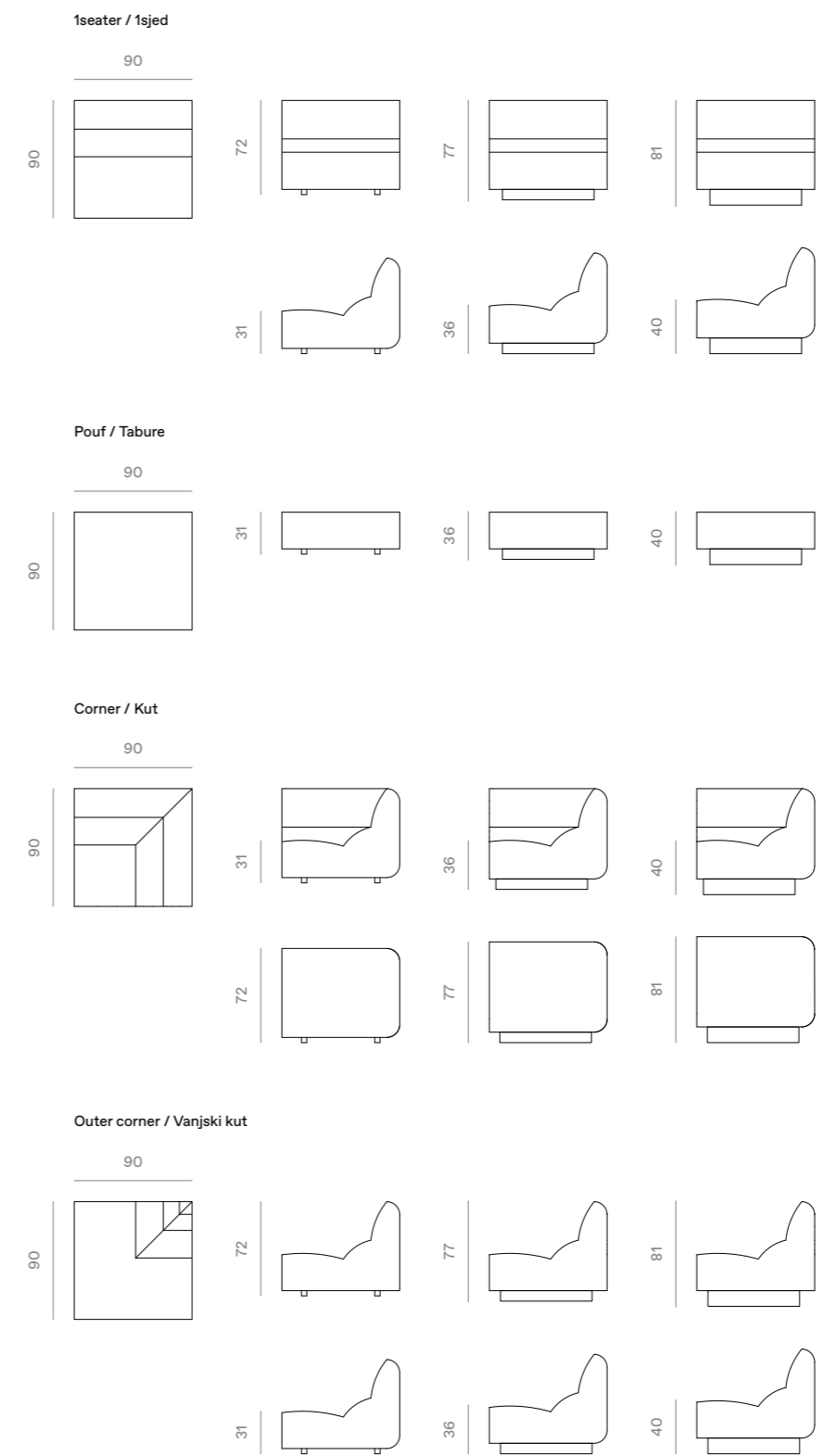

combine



Combine is a seating system with reduced form characterized by the profile of the lower side of the backrest. Depending on the choice of the finishing of legs made in solid wood and cushions, the style and the usage context of Combine varies, enabling the user to define their own preferred character of the sofa.

Design: Numen / For Use

Combine je sustav za sjedenje s reduciranim volumenom i karakterističnim skošenjem donjeg dijela naslona u svrhu dobre ergonomije. Ovisno o izboru drvenih ili metalnih nogu te opcionalnih jastuka, stil i kontekst uporabe ove garniture mutira, pružajući korisniku vlastitu definiciju njezinog željenog karaktera.







2seater sofa / 2,5seater sofa / 3seater sofa



end unit (L/R)

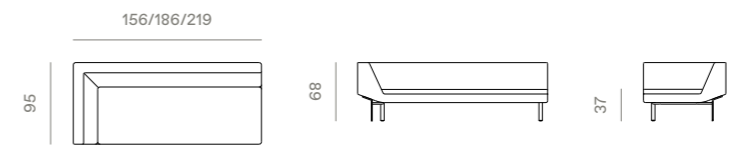

chaise lounge open end (L/R) 95



chaise lounge (L/R) 95

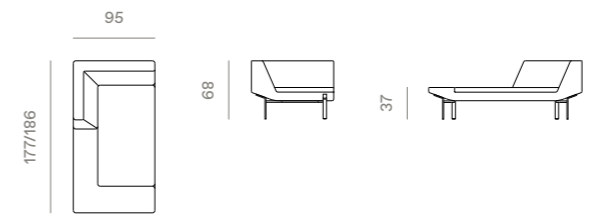

chaise lounge (L/R) 105

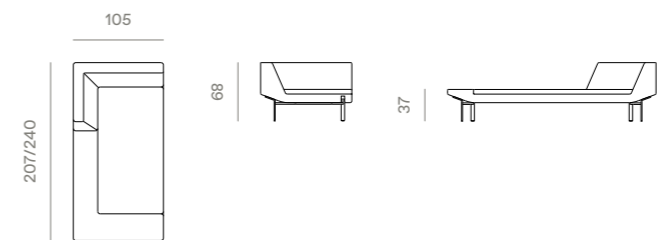

impression



The Impression sofa at the same time incorporates elegance and comfort. Low and slim armrests and backrest form a gentle impression with curved inner components providing comfortable seating. Filigree but strong legs emphasize a fresh look. Delicate appearance is combined with a special detail on the armrests. An impression on each corner is repeated also on added cushions. The sofa comes with open-end modules, which accommodates various different compositions.

Design: Meike Harde

Sofa Impression objedinjuje elegantan izgled s udobnošću sjedenja. Niski i prilično uski naslon te rukonasloni stvaraju rafiniranu formu sa svojim zaobljenim unutarnjim dijelovima. Tanke metalne noge naglašavaju raskošnost ojačanog dijela sofe. Delikatnost forme se također očituje u posebnom detalju rukonaslona koji se ponavlja i na jastucima. Sofa je dostupna i u modulima s otvorenim krajem što otvara mogućnost raznovrsnih kombinacija modula.





armchair, base 01



base 02



2seater / 2,5seater / 3seater, base 01



base 02

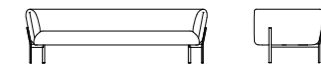

chaise longue (L/R), base 01



base 02

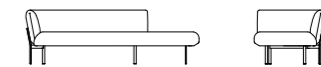

end unit (L/R), base 01



base 02

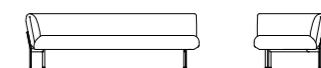

convert



Convert is a modular seating system providing various combinations and compositions in space. Its flexible structure can be modified over time. Changing of the position of the seating modules, fixed backrests or the ones with a mechanism and a platform for storage, offers a variety of different possibilities applicable to both residential and public interiors. Essentially discreet in its shape, through disposition of structural elements, selection of material and several types of cushions, the system changes its character and function depending on the user's preference.

Design: Simon Morasi Piperčić

Convert je modularan sistem za sjedenje koji nudi razne mogućnosti slaganja kompozicija u prostoru, a fleksibilan je i unutar svoje strukture pa se može modificirati tijekom vremena. Izmjenom pozicija sjedećih modula, fiksnih naslona ili onih s mehanizmom te platoa za odlaganje dobivaju se razne uporabne situacije predviđene za privatne i javne prostore. U osnovi oblikovno diskretan, sistem kroz dispoziciju strukturalnih elemenata, odabir materijala i nekoliko vrsta jastuka mijenja karakter i funkciju, ovisno o želji korisnika.





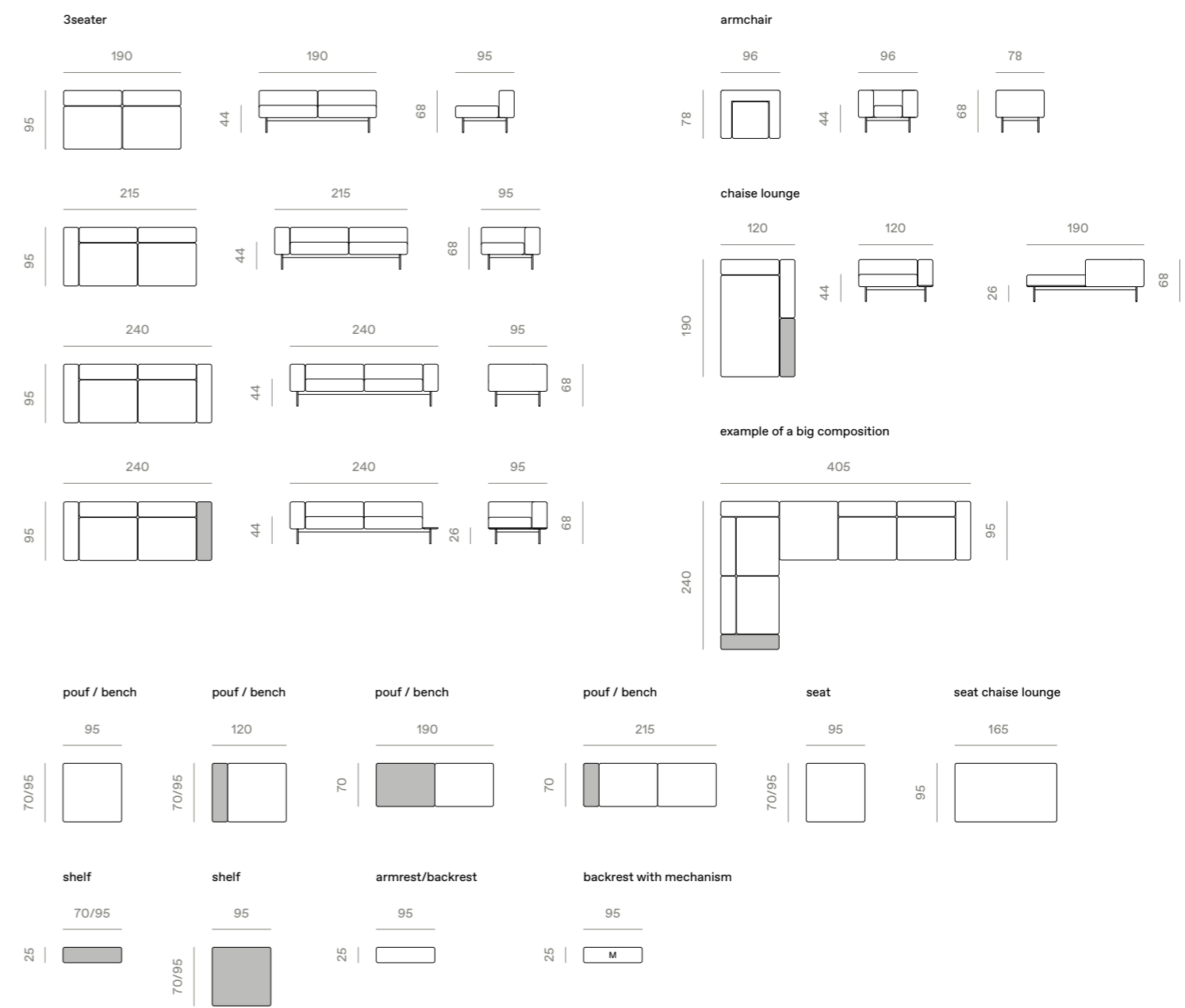

segment



Segment is a modular system available as a multi-base series of components that can form various functional or unconventional compositions. Its identity is determined by the form of its main component with its characteristic basic double-sided ends sloping at a 45° angle, which offers perfect ergonomics. The combinations in a series of multiple bases can on one side be supported by a metal feet, while a supporting wooden component with a high lustre finish can extend from beneath the base on the other side.

Design: Numen / For Use

Segment je modularni sustav dostupan kao višebazni niz elemenata s kojim se mogu kreirati raznolike funkcionalne, ali čak i nekonvencionalne kompozicije u prostoru. Njegov je identitet izgrađen kroz formu glavnoga sastavnog elementa s karakterističnim osnovnim dvostranim kosinama na završetcima pod kutem od 45 stupnjeva, čime se ostvarila kvalitetna ergonomija. Kombinacije u nizu od nekoliko baza na jednom će kraju biti nosive na metalnom nožištu, a ispod baza drugog kraja sustava će se prostirati nosivi drveni element lakiran do visokog sjaja.



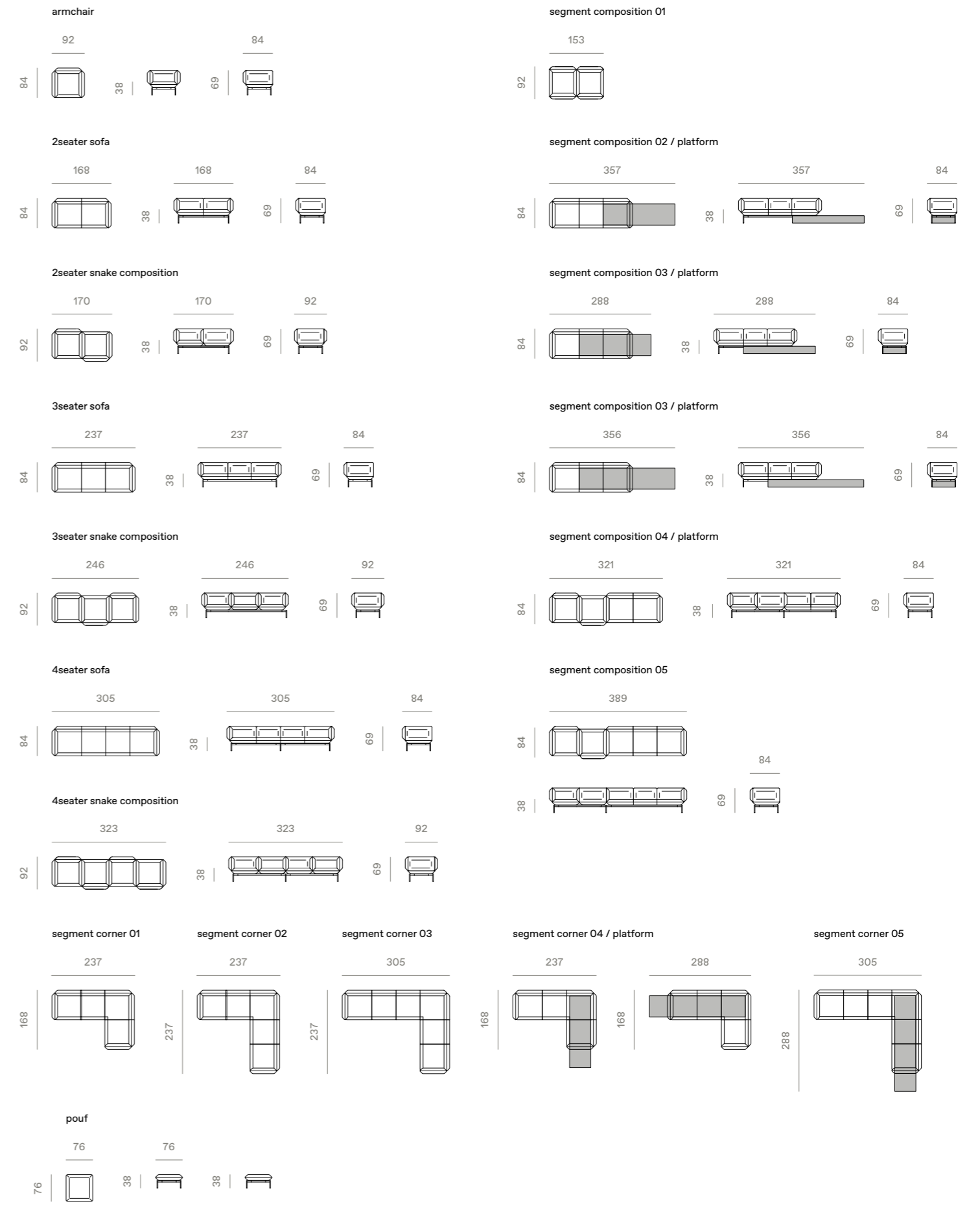

seam



The design of the Seam sofa integrates elegant form and purity of a single volume for comfortable seating, without cushions that are often reminiscent of residential settings. The extremely deep armrest and backrest sink in an expressive curve towards the seat, which represents an ergonomic solution and at the same time the highlight of the sofa's design. The geometry of the curvature is accentuated with the stitches on the covers.

Design: Böttcher & Kayser

Dizajn sofe Seam objedinjuje elegantnu formu s čistoćom mono-volumena za udobno sjedenje, bez jastuka koji često asociraju na stambene ambijente. Izrazito duboki rukonaslon i naslon u izražajnom luku poniru prema sjedalu, što je istovremeno i ergonomski kvalitetno rješenje i svojevrsni akcent njezinog dizajna. Geometrija samog zaobljenja naglašena je šavovima na presvlakama.



Golden Key
Award



2seater sofa / 3seater sofa

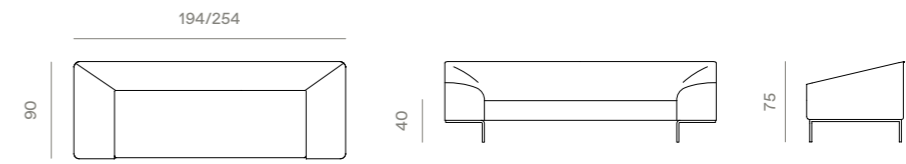

corner extended (L/R)

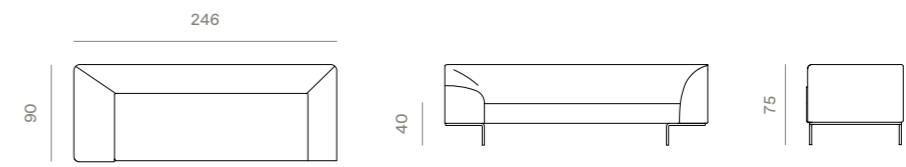

end unit (L/R)

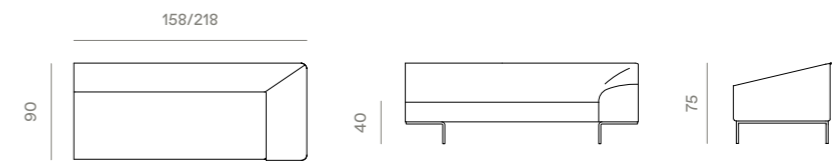

chaise longue (L/R)

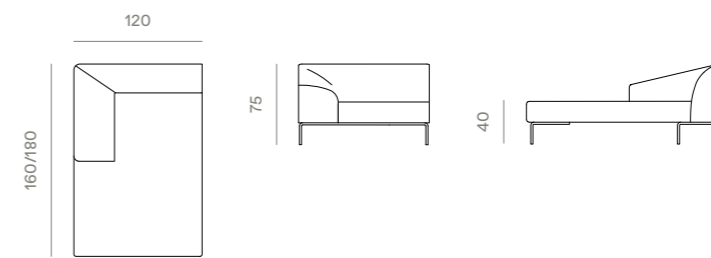

pouf

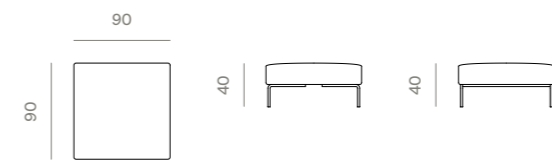

revolve



Revolve is a multifunctional sofa that unites seating and sleeping needs. Its design can make a grand statement in a room, and with just a smooth rotation of 180 degrees transforms sitting into sleeping. Revolve offers an optimal sleeping quality while its padding resembles self-standing mattresses, made of high resilience foam. Thereby it provides equal quality of your sleep on entire lying surfaces – whether in the middle or on the sides. Thanks to its dynamic shape and dual function it can be used in homes, offices and secondary residences.

Design: Numen / For Use,
Ivana Borovnjak, Roberta
Bratović

Revolve je multifunkcionalni ležaj koji objedinjuje funkciju sjedenja i spavanja na inovativan način. Njegov dizajn ističe se u svakom interijeru, pružajući mu dodatnu vrijednost. Jednostavnom se rotacijom za 180 stupnjeva transformira iz sofe za sjedenje u ležaj za spavanje. Revolve je savršen ležaj za dvoje zahvaljujući punjenju koje je jednako onome kao u samostojećim madracima izrađenima od hladne pjene. Na ovaj je način omogućena jednaka kvaliteta spavanja na čitavoj površini, bilo u sredini ili na prijelazima sa strane. Njegov dinamičan oblik i dvostruka funkcija čine ga prikladnim za uređenje doma, ureda ili vikendice.



Golden Key
Award



reddot award
winner 2012

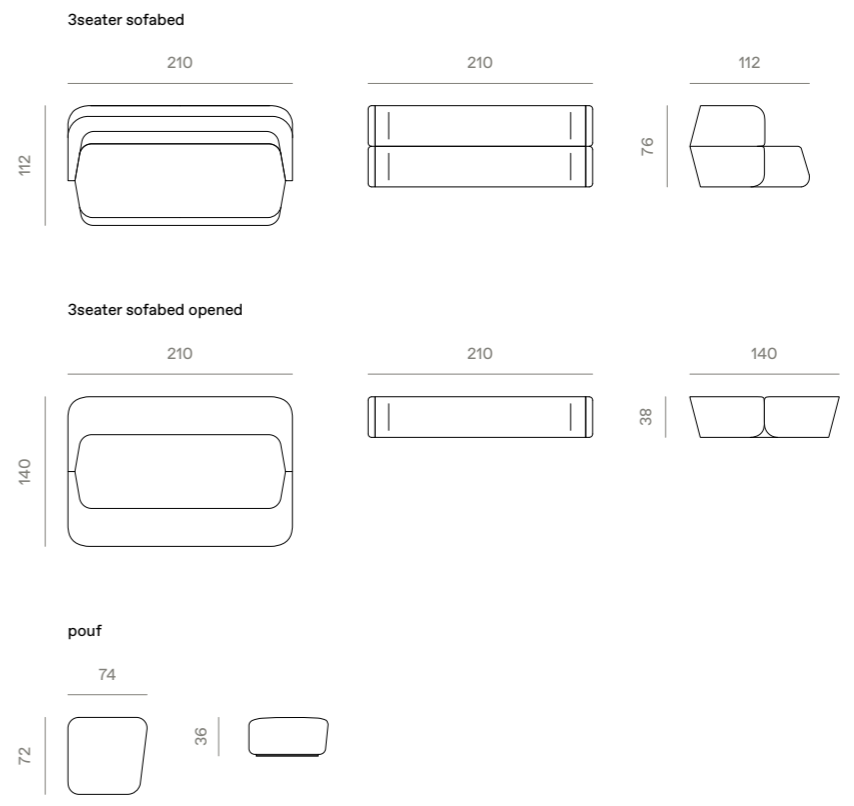

up-lift



Up-lift represents innovation in a sofa typology with its integrated bed. Its shape allows for transformation through the simple raising up of the backrest, which causes the automatic lift of the leg rest, whilst maintaining an optimal height. Sofa's harmonious form consists of two separate volumes, which rotate around each other in an eccentric fashion. The armrest is curved, as it also functions as a wheel, and the backrest is tilted and rounded to minimize the volume.

Design: Neisako

Up-lift predstavlja inovaciju u segmentu tipologije sofe s integriranim ležajem. Oblikovan je na način da se transformacija postiže jednostavnim podizanjem (up) naslona koji automatski podiže (lift) donju zonu ležaja zadržavajući pritom optimalnu visinu. Formu čine dva volumena koji po principu ekscentra rotiraju jedan oko drugog tvoreći skladnu cjelinu u oba položaja. Rukonaslon je zaobljen jer je preuzeo funkciju kotača, a naslon ukošen i zaobljen radi smanjenja nepotrebnog volumena.



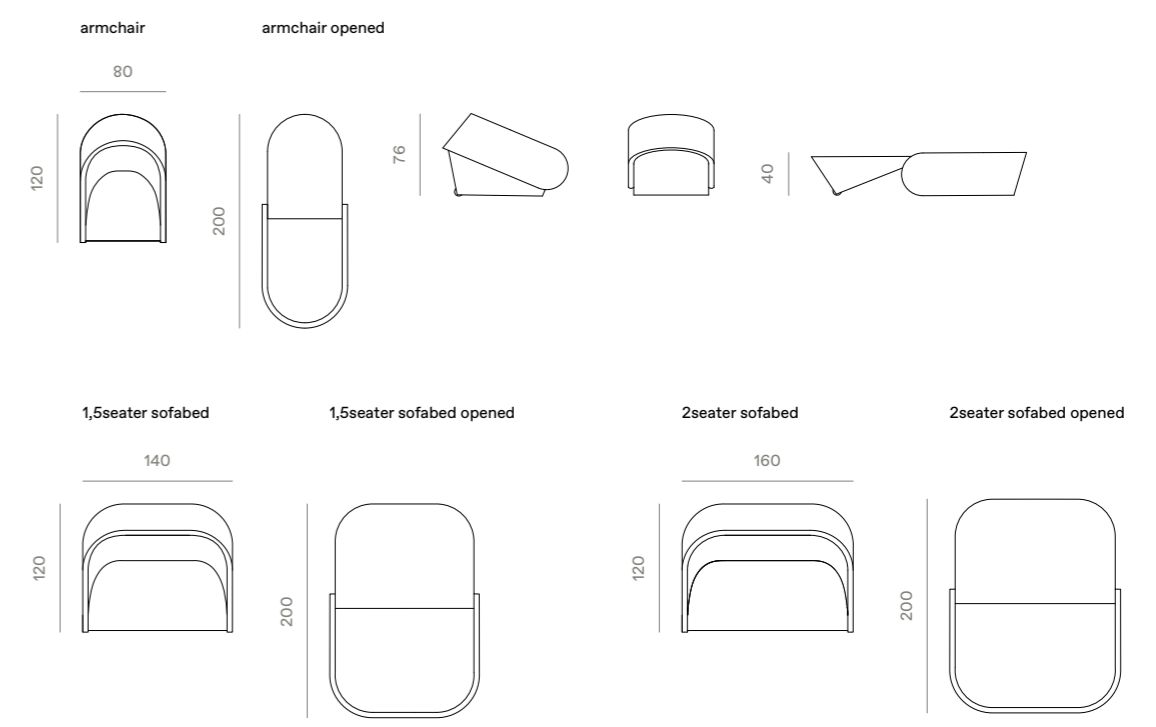

pil-low



Pil-low has smooth transformation from a sofa into a bed. In the closed position, between the volume of the seat and the backrest, there is a hard triangular pillow that adds to the quality of sitting. The sofa opens when entirely lifted forward and rotated around the sub-construction, hiding space for storing bed linen. The backrest is then rotated backwards and the emerging gap is used for storing the pillow. With this system, all elements of the sofa are put to use as an expanded sleeping platform.

Design: Neisako

Pil-low ima laganu transformaciju iz sofe u ležaj. U zatvorenom položaju, između volumena sjedala i naslona postavljen je čvrsti trokutasti jastuk koji doprinosi kvaliteti sjedenja. Sofa se rasklapa tako da se čitava podigne prema naprijed rotirajući oko podkonstrukcije koja skriva prostor za posteljinu. Zatim se naslon zarotira unatrag, a u nastali se procjep ubacuje jastuk. Takvim su sustavom iskorišteni svi elementi sofe, a dobivena je proširena ploha za spavanje.





3seater sofa bed

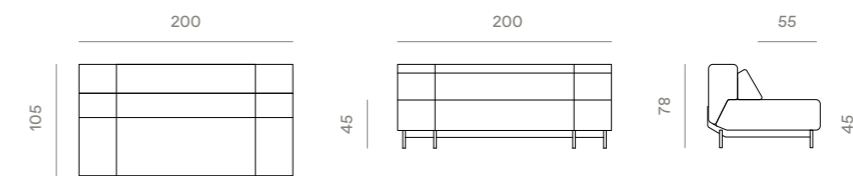

3seater sofa bed opened

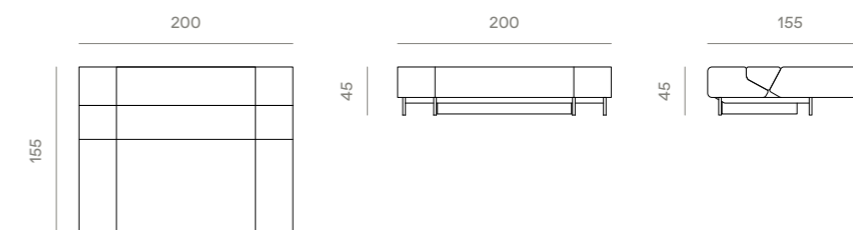

bavul



Bavul is a multifunctional upholstered object that transforms from a bench to a bed. In its basic form Bavul serves as a seating system in a living room, dining room at a table, or in a hallway – waiting to welcome your needs for the additional bed. Its dimensions are also perfect match for the hospitality projects where it saves the precious space. With strong visual appearance and color combinations, Bavul blends in various interior styles.

Design: Lea Aviani

Bavul je višenamjenski ojastručen komad namještaja koji se iz klupe jednostavno pretvara u krevet. U svom osnovnom obliku Bavul je sistem za sjedenje u dnevnom boravku, blagovaonici ili hodniku koji spremno odgovorava vašoj potrebi za dodatnim ležajem. Svojim se dimenzijama savršeno uklapa u ugostiteljske prostorije jer doprinosi štedljivom korištenju prostora. Bavul se izvrsno uklapa u interijere različitih stilova zahvaljujući svojoj snažnoj vizualnoj pojavnosti i raznim kombinacijama boja.





bavul bench & bed

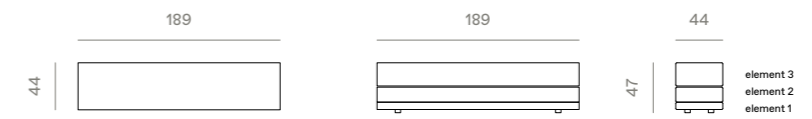

bavul bench & bed opened

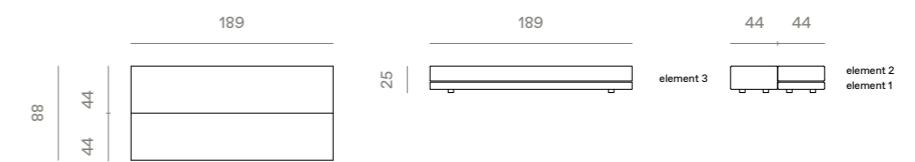

fade



Fade is a sofa-bed collection featuring a characteristic, continuous diagonal bevel of edges, applied on all of the elements of the system. This formal fade-out of volumes, varying in depth or height, results in a soft transition of elements, uniting the cuboids of seat, backrest and armrests.

Design: Numen / For Use

Fade je kolekcija garnitura na razvlačenje s karakterističnim kontinuiranim dijagonalnim skošenjem rubova koje se ponavlja na svim elementima kolekcije. Ovakav naglašen nestanak volumena koji varira u dubini ili visini rezultira mekim prijelazom elemenata, ujedinjujući kuboide sjedala, naslona i rukonaslona.



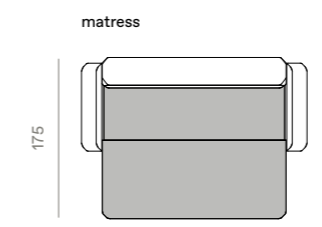
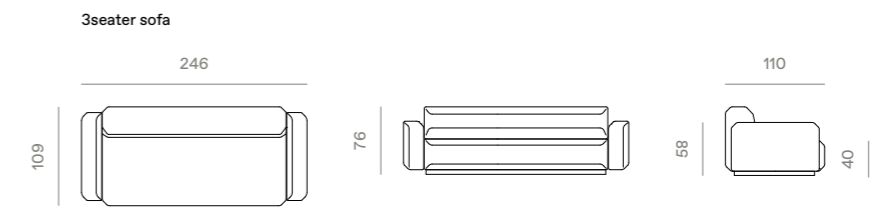
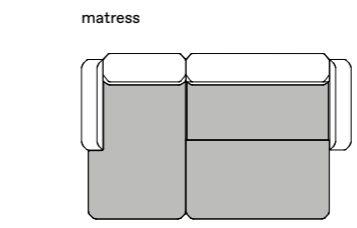
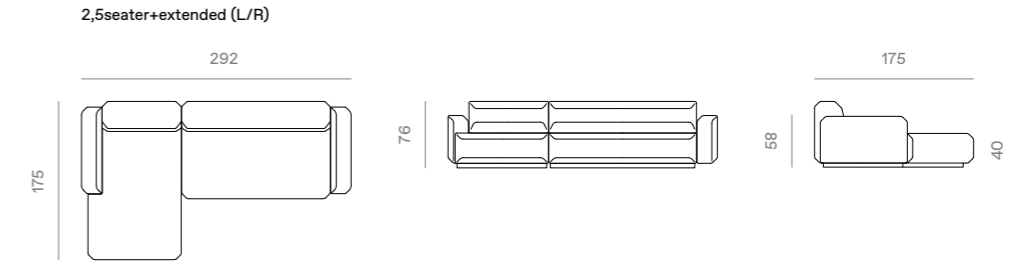
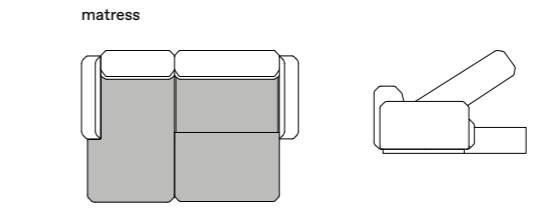
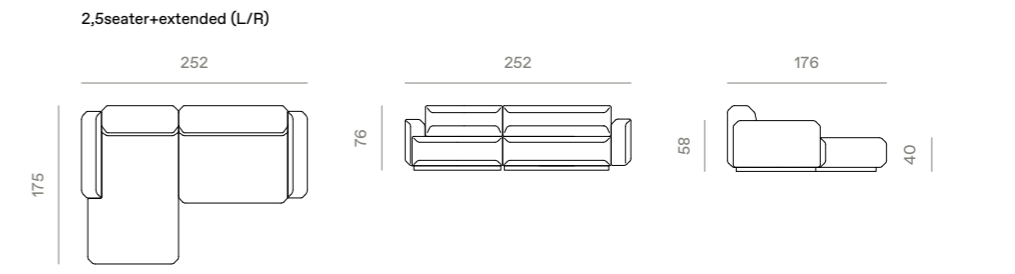

combo



The Combo set combines different functions: sitting, lying, playing and leisure. The unfolding procedure is simple, and the set includes a storage area. Combo is conceived as an extremely simply designed platform that can support different living scenarios, whereas its playfulness is complemented by the supplementary feather-stuffed soft cushions.

Design: Prostoria

Combo garnitura kombinira različite funkcije: sjedenje, ležanje, igranja i dokolicu. Postupak rasklapanja je lagan, a garnitura uključuje i spremišni prostor. Combo je osmišljen kao krajnje jednostavno oblikovana platforma spremna podržati različite životne scenarije, a njenu razigranost dopunjuju dodatni mekani jastuci punjeni perjem.





2,5seater+extended (L/R)

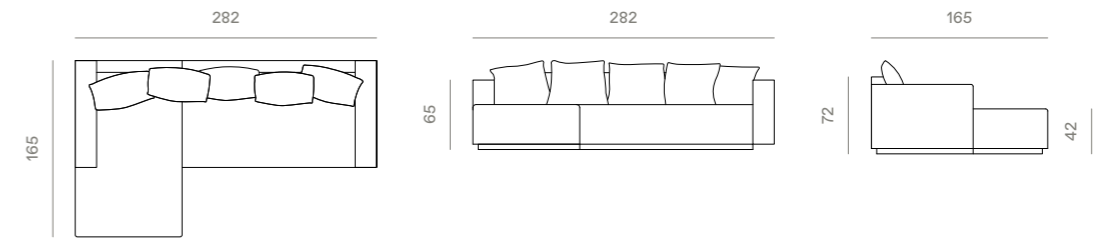

2,5seater+extended (L/R) bed

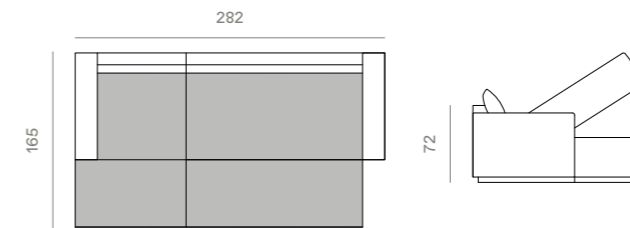

2seater+extended (L/R)

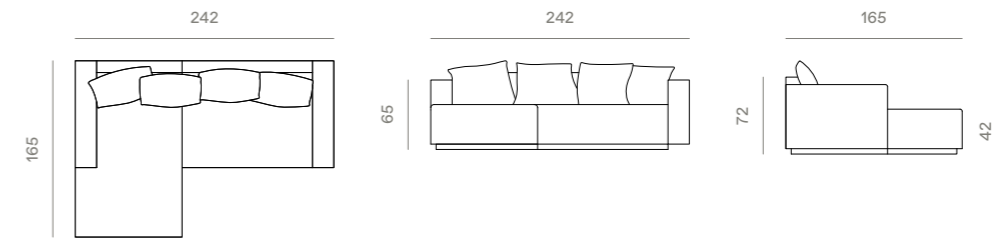

2seater+extended (L/R) bed

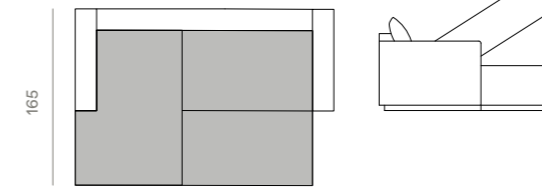

3seater sofa

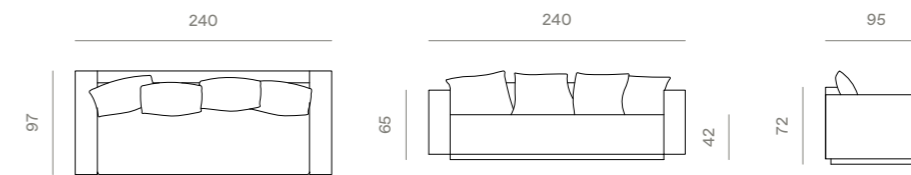

3seater sofa bed

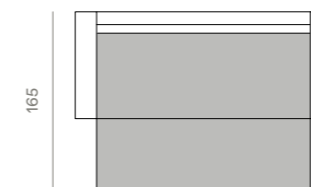

chaise lounge (L/R)



simetria coat stand

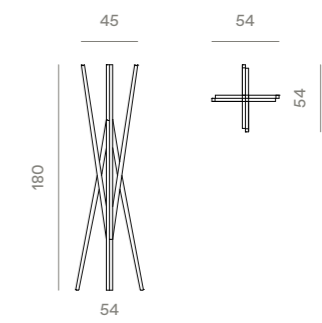

combo

shtef



The basic structural module is a square that is applied on the wall as a visually autonomous object. However, to make the system adaptable to various ambiances and intended purposes, several modules with different proportions have been developed as well as freestanding variants. L-cross-section shelves are inserted in the structural module; they come in 7 different formats and can be used together with the rear part mounted upward or downward. Shelf is made out of aluminium to achieve lightweightness.

Design: 3LHD, Grupa

Osnovni strukturni modul je kvadratnog formata i aplicira se na zid poput likovno autonomnog objekta, no kako bi se sustav mogao prilagoditi različitim ambijentima i namjenama, razvijeni su i moduli drugačijih proporcija, kao i varijanta koja se oslanja na pod. U strukturni modul se ubacuju police L-presjeka koje dolaze u 7 formata i mogu se koristiti sa stražnjom stranom postavljenom prema gore ili dolje. Polica je izrađena iz aluminija radi fizičke lakoće.



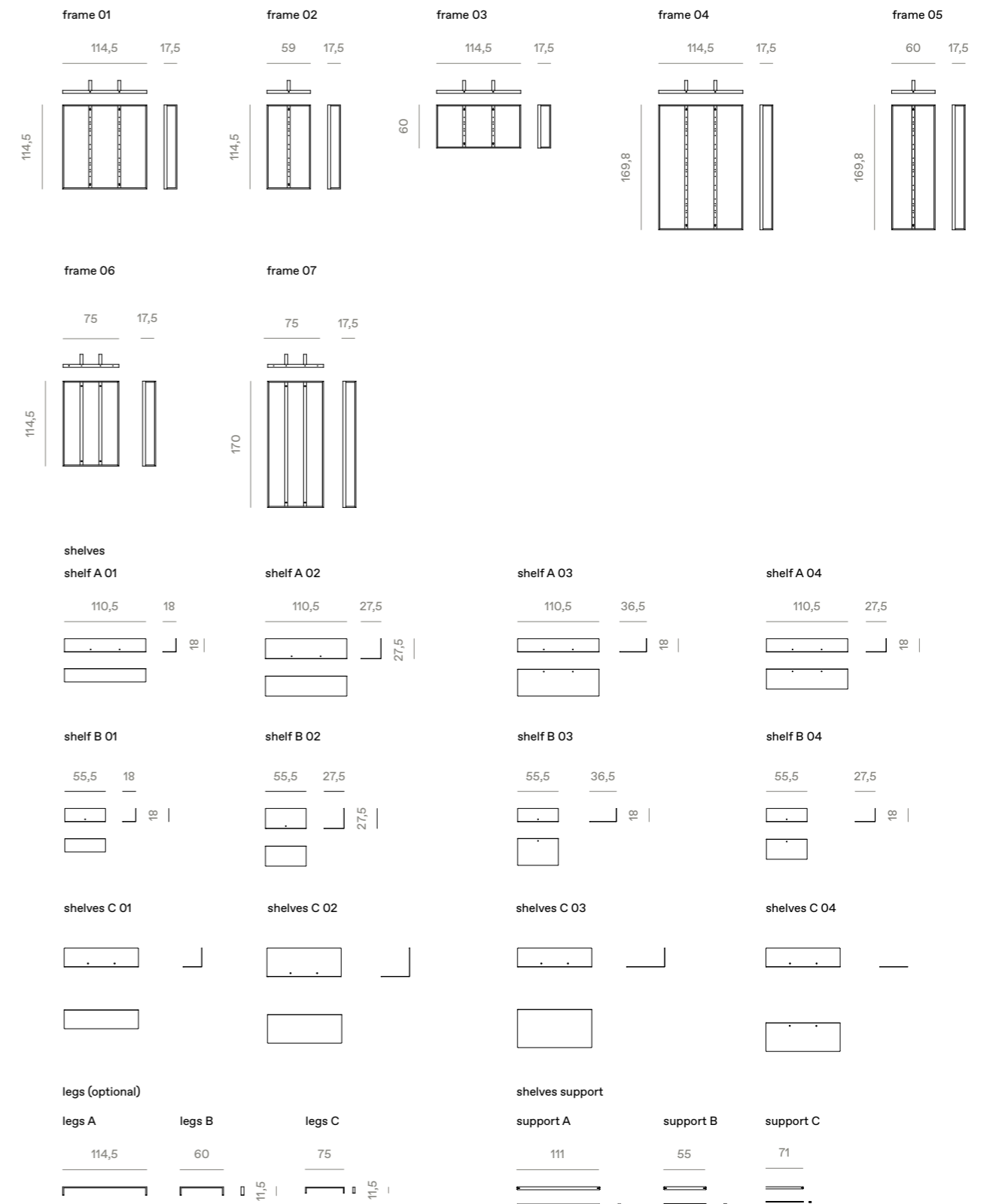



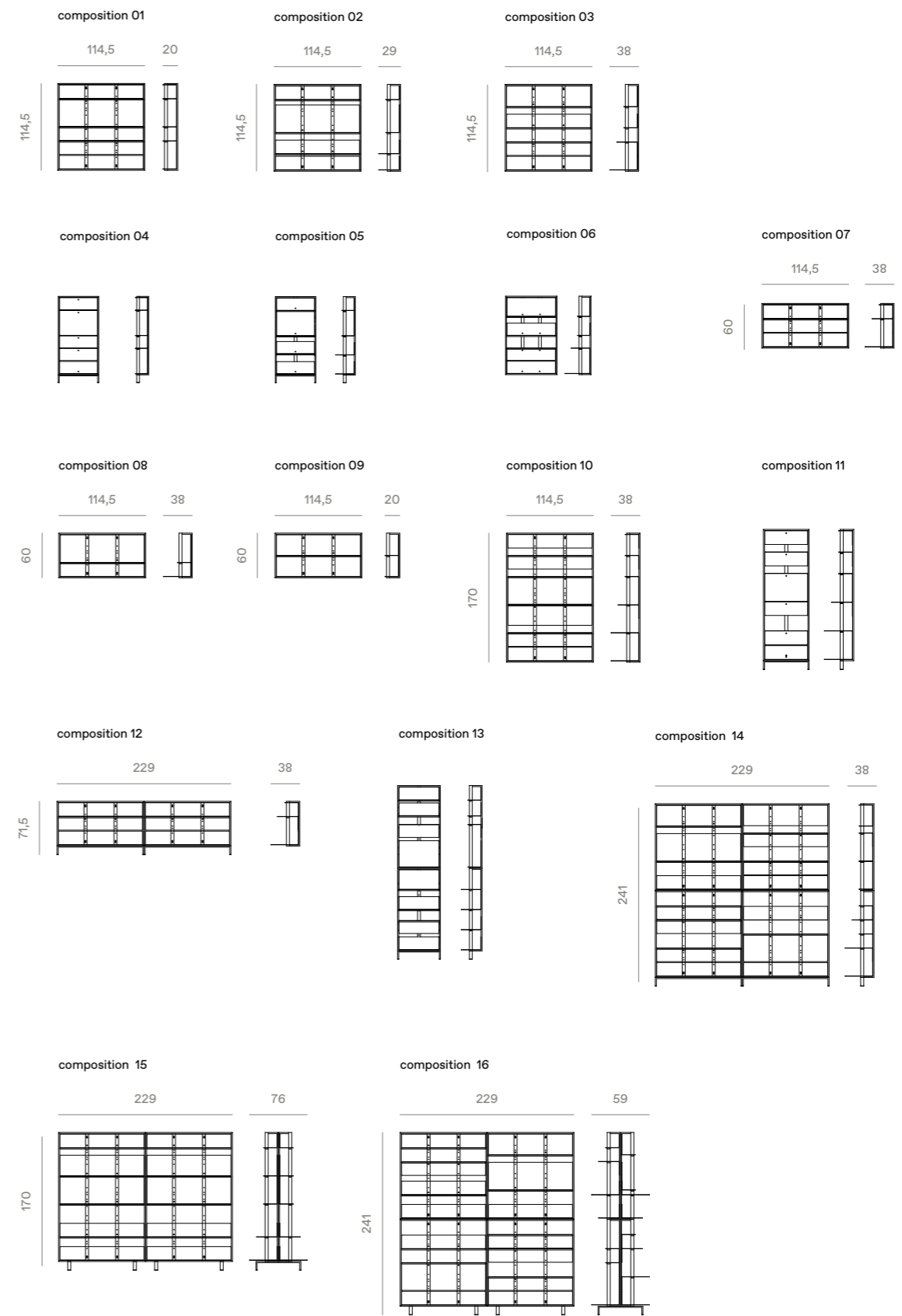

knif

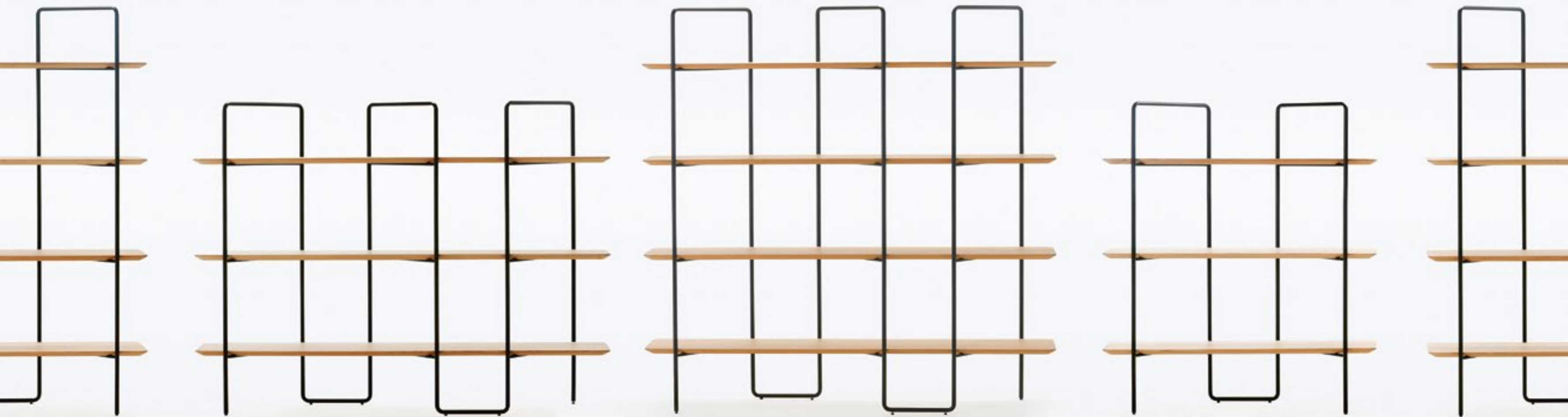

Knif is a modular shelving system which caters for customized solutions and diverse user needs in various concepts of interior design. Composed of the metal construction and solid wood shelves, it provides numerous combinations of heights and widths that can be upgraded over time. With visually light and low-key appearance, this sturdy structure sets the stage to the user's content. Quite spacious shelf's depth provides for exhibiting objects of diverse nature.

Design: Studio RU:T

Knif je modularni sustav polica koji omogućuje višestruka prostorna rješenja. Sastoji se od metalne konstrukcije i polica izrađenih od punog drva, a pruža mogućnost brojnih kombinacija visina i širina, koje se s vremenom mogu i nadograđivati. Osnovni sustav sastoji se od šest modula koji dolaze u gotovim pakiranjima. Uz dva dodatna povezujuća elementa, od njih je moguće složiti novih devet kompozicija. Osnovni model dostupan je u crnoj metalnoj konstrukciji i polici od punog drva.



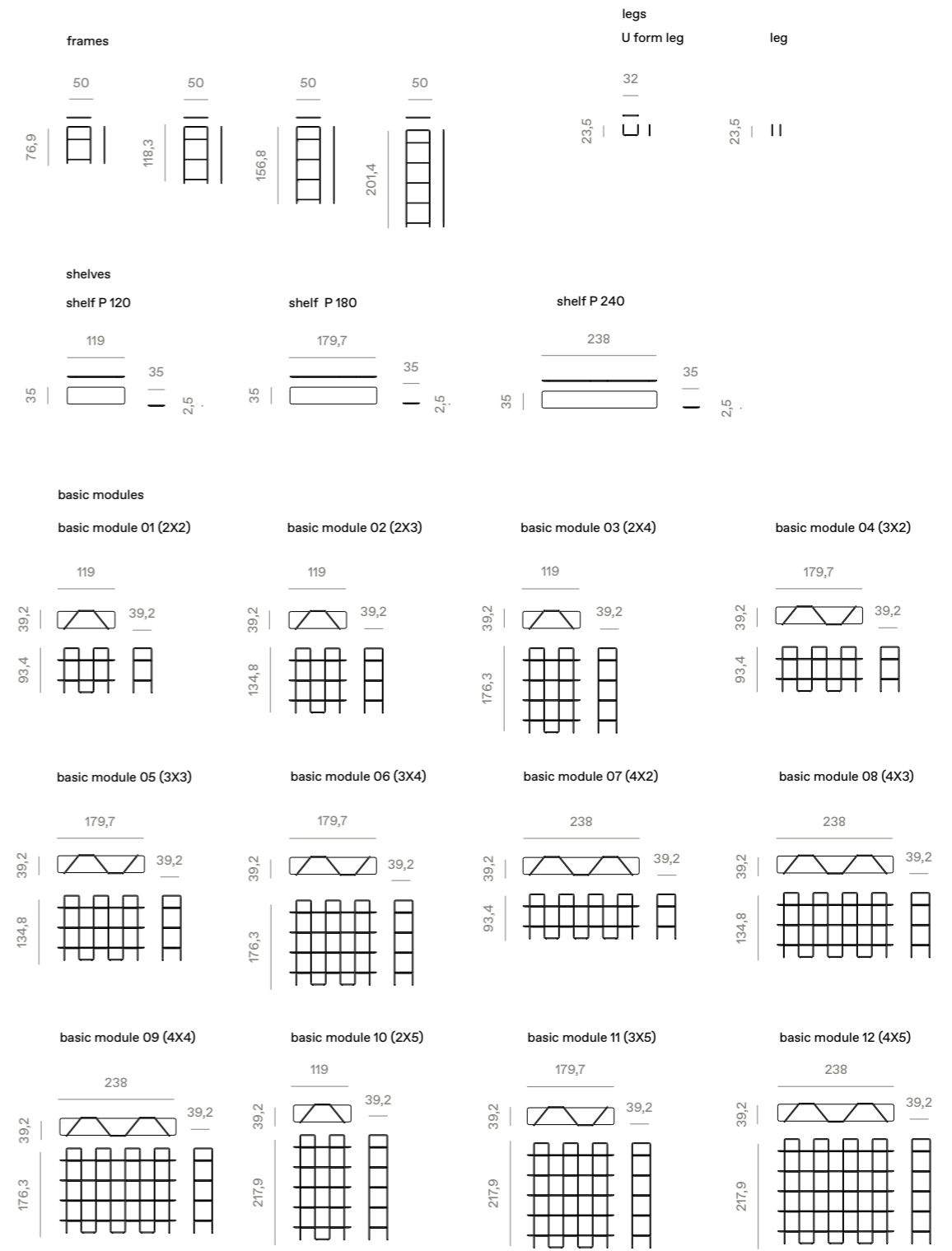
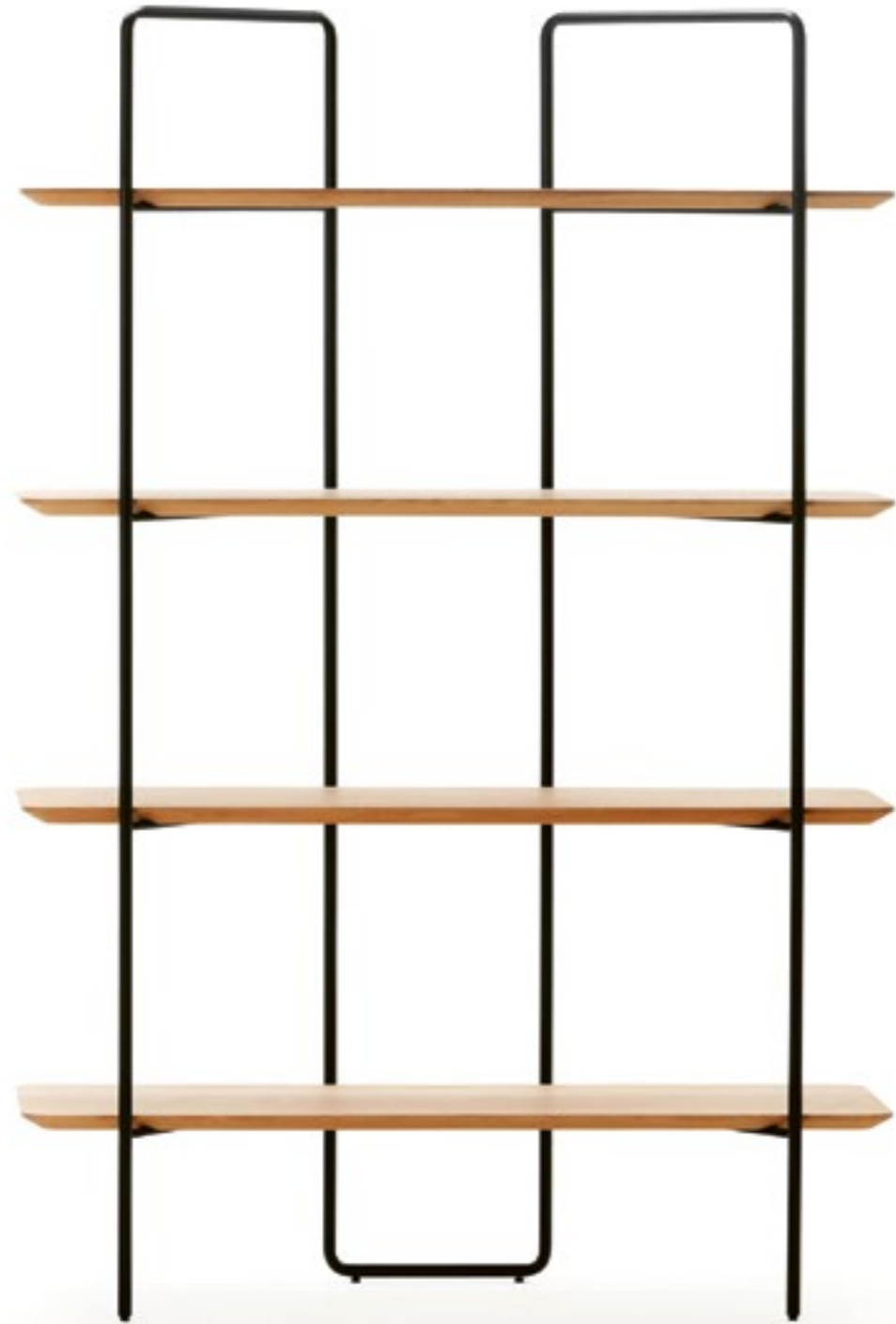

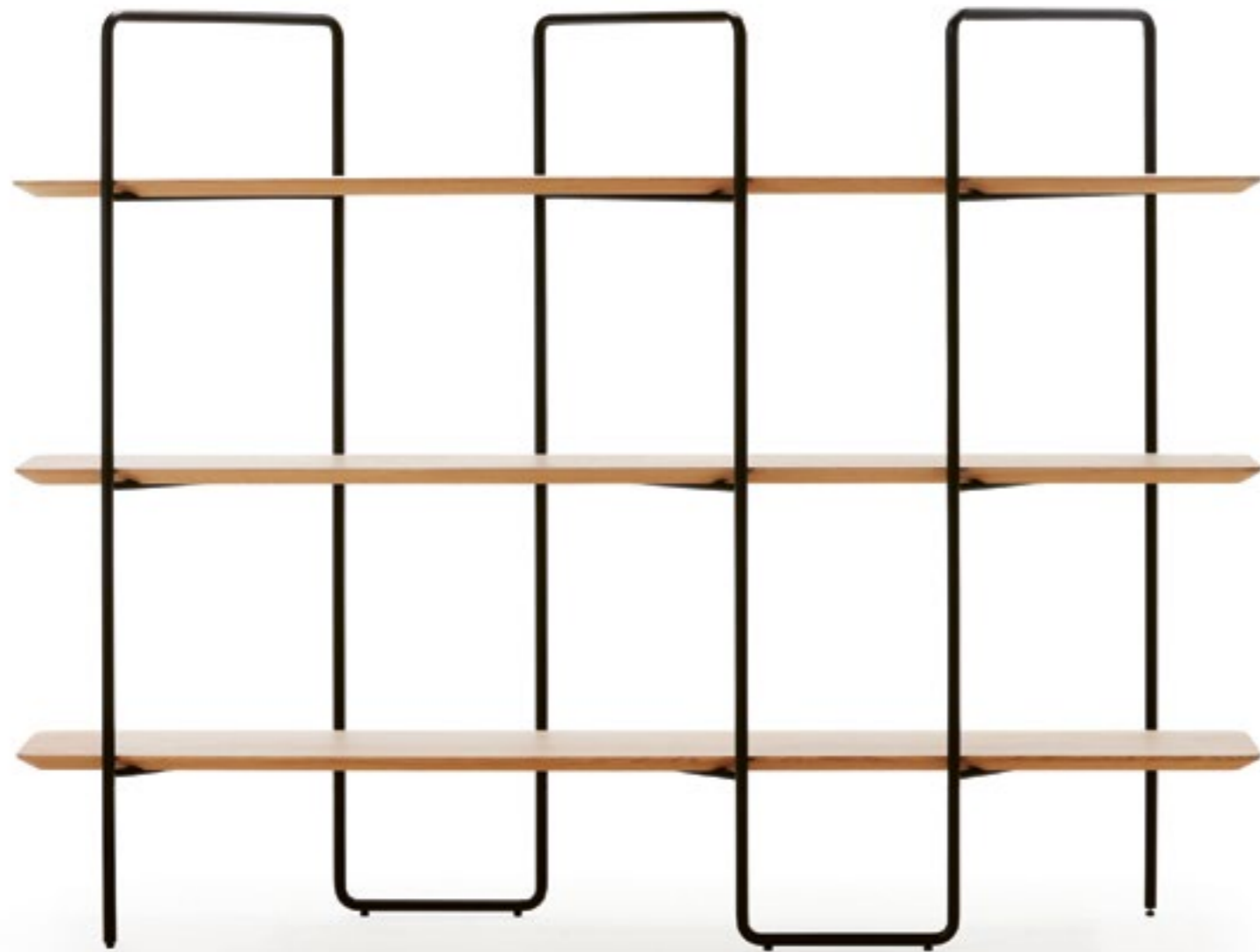

chairs
easy chairs
tables
small tables

stolice
naslonjači
stolovi
stolići



kontrapunkt



Kontrapunkt is a design-led alternative to a traditional bulky recliner that relies on electric motors to turn into a lounger. To transform Kontrapunkt, you simply need to raise an armrest and the armchair eases into a reclined position with a footrest that kicks out from under the seat. This simple transition is achieved with the innovative mechanism that is part of the design. The ergonomic shape and elasticity of the construction materials as well as different versions of the product's skin, upholstered either in fabric or leather result in great comfort.

Design: Neisako

Kontrapunkt je naslonjač koji se otvara u ležaljku i predstavlja alternativu standardnoj glomaznoj tipologiji naslonjača za odmaranje. Jednostavnim podizanjem naslona za ruke, naslonjač se otvara u poziciju ležaljke pomoću inovativnog prekretnog mehanizma koji konzolno nosi naslon za noge i naginje naslon za leđa u odgovarajući ergonomski položaj. Udobnost je postignuta ergonomskim oblikom, elastičnošću konstruktivnih materijala i korištenjem raznolikih verzija vanjske tapecirane navlake u tkanini ili koži.





recliner

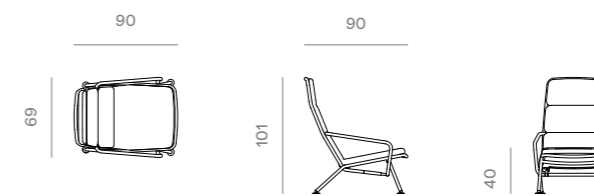

recliner opened

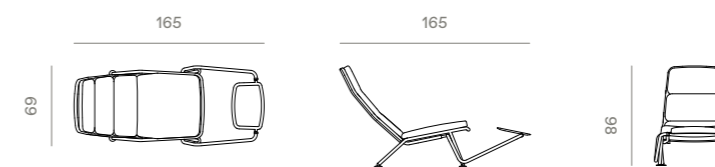

polygon



Polygon is an easy chair with highly graphic characteristics reminiscent of an architectural plan. The design is articulated as a series of separate elements connected by a bent tubular steel construction to meet all functional parameters and eliminate any bulkiness. The final result is a perfectly ergonomic and comfortable product available in an indoor or outdoor version. The collection is additionally expanded with low tables (indoor/outdoor) whose metal legs are constructed to follow the overall design.

Design: Numen / For Use

Naslonjač Polygon snažnog je grafičkog karaktera i podsjeća na arhitektonski plan. Njegov dizajn sastoji se od serije odvojenih elemenata – naslona, sjedala i rukonaslona – povezanih konstrukcijom od svinutih čeličnih šipki. Polygon zadovoljava sve funkcionalne parametre i doprinosi lakoći prostora svojim skromnim dimenzijama. Ovo je savršeno ergonomičan i udoban naslonjač kojemu su pridruženi niski stolići. Kolekcija je dostupna za unutrašnje i vanjske prostore.







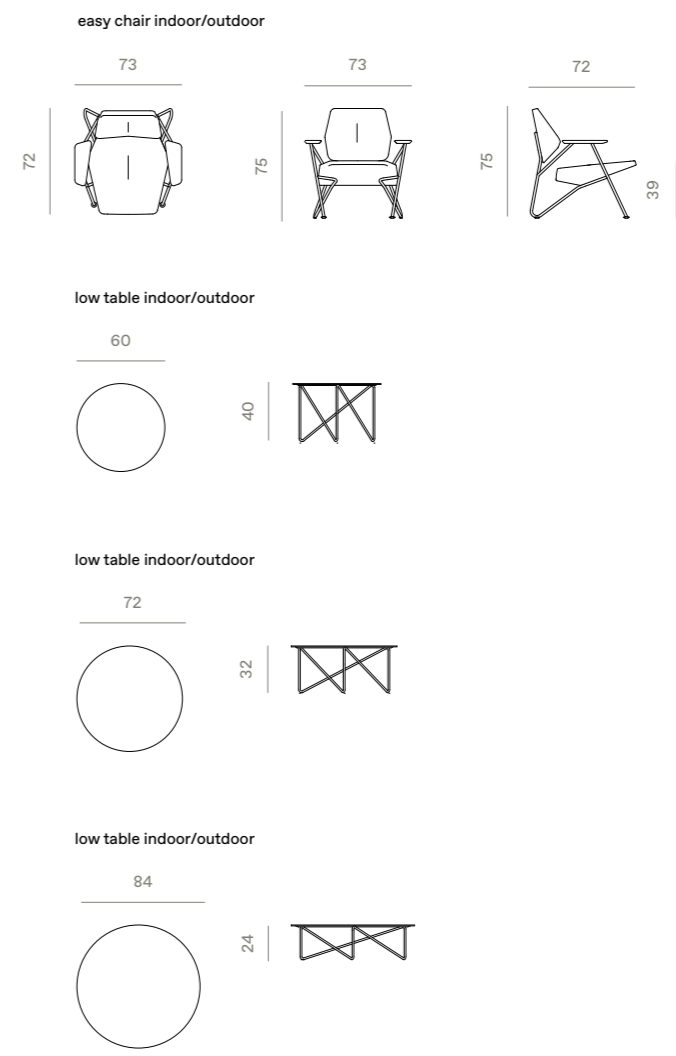

monk



The Monk collection includes a chair, easy chair and a chair with the central swivel base (fixed or with castors). The chair's shell is composed of two bent pieces of plywood upholstered in fabric, with a simple structure made of massive wood or metal lying underneath. The armrest forms part of the seat and the whole shell appears to float independently of its relatively inconspicuous support. In addition to the basic barstool model, there is also a new version of Monk barstool and the counter stool available with the backrest upholstered in fabric. The collection also includes a dining room table, bench and low tables.

Design: Grupa

Kolekcija Monk sastoji se od stolice, naslonjača i stolice sa centralnim metalnim nožištem (fiksiranim ili s kotačićima). Osnovnom modelu barske stolice sada se pridružila i nova varijanta visoke i niske barske stolice s naslonom presvučenim tkaninom. Barske stolice dolaze u dvije visine, s četiri noge ili metalnom konstrukcijom. Osnovnom modelu barske stolice sada se pridružila i nova varijanta visoke i niske barske stolice s naslonom presvučenim tkaninom. Kolekcija također uključuje stolove, klupu i stoliće.













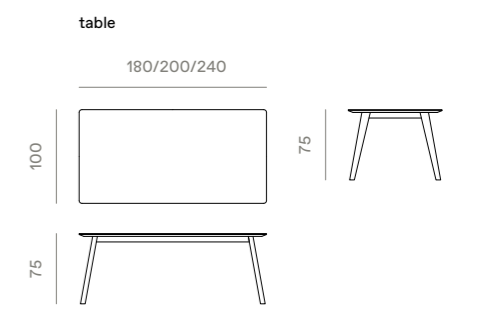
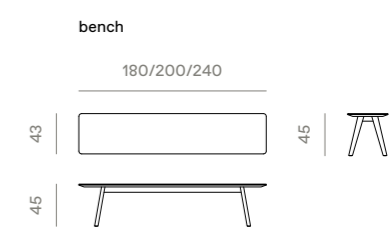
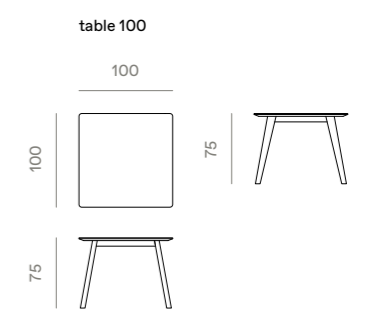
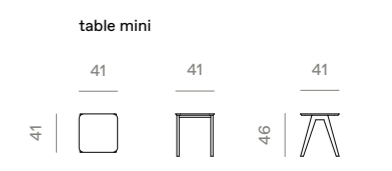
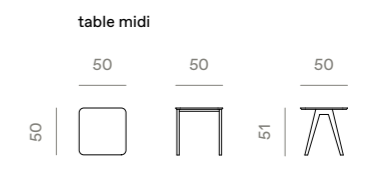
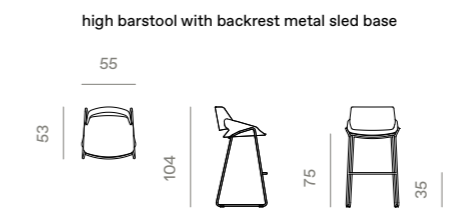
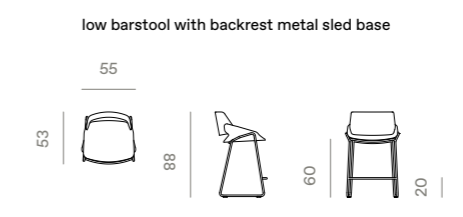
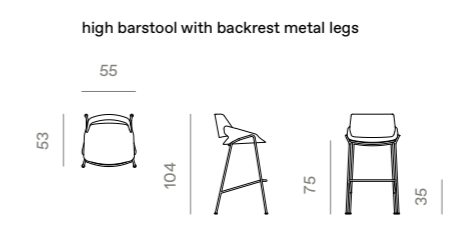
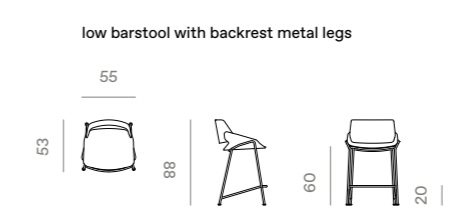
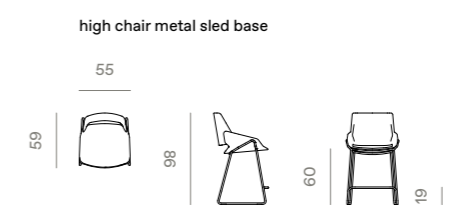
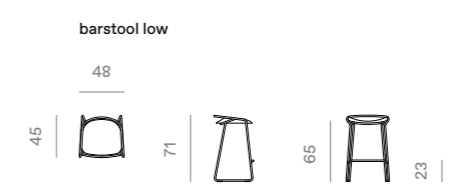
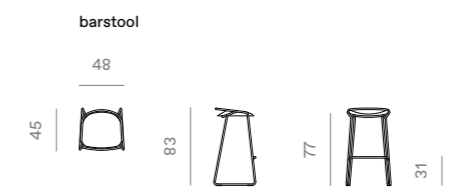
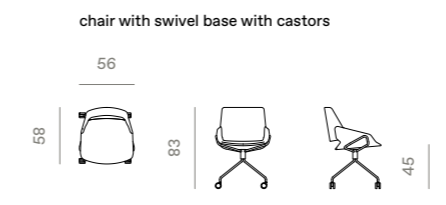
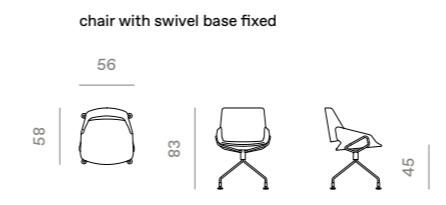
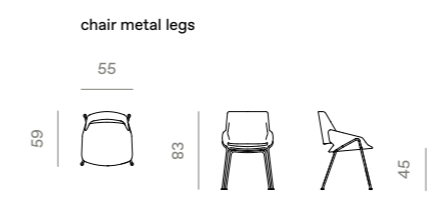
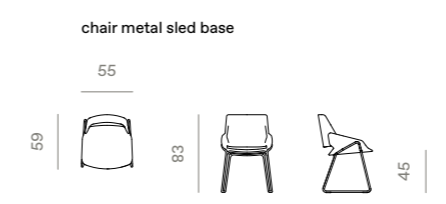
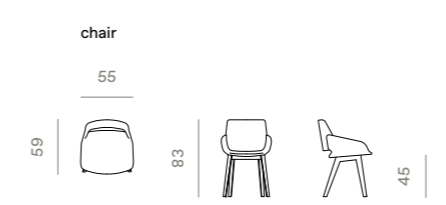
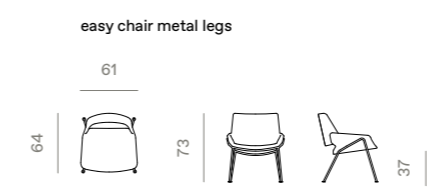
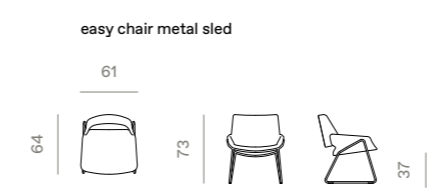
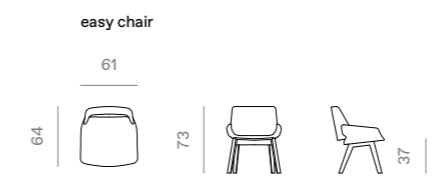

tinker



Designed to be inviting, Tinker is conducive to comfortable sitting and relaxed work by a mid-high table. Its form highlights the plywood backrest and the seat shell, upholstered in fabrics. In terms of typology, Tinker lies between a chair and easy chair. Therefore, the seating cushion is intentionally softer, accentuating the feeling of cosiness and luxury, also achieved through its overall ergonomics. The slim steel legs keep the base 'afloat', and they are available in diverse coating finishes.

Design: Grupa

Svojom dizajnom Tinker omogućava udobno sjedenje i opušten rad pored stolića srednje visine. Oblik naslonjača naglašen je naslonom izrađenim od šperploče te sjedalom presvučenim tkaninom. Specifične tipologije, Tinker se nalazi negdje između klasičnog naslonjača i stolca. Jastuk sjedišta namjerno je omekšan kako bi se dodatno naglasio osjećaj udobnosti, koji je također postignut cjelokupnom ergonomijom. Zbog tankih čeličnih nogu, dostupnih u različitim završnim obradama, čini se kao da osnova „pluta“.







easy chair

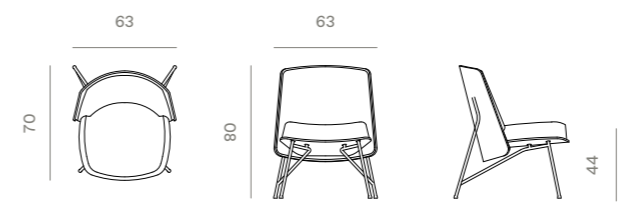

low table

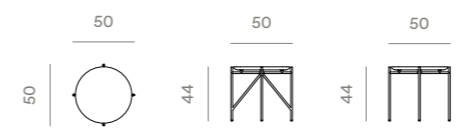

low table

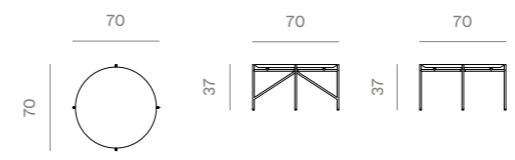

low table

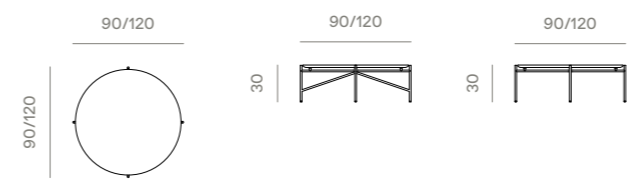

low table

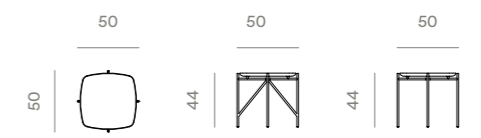

low table

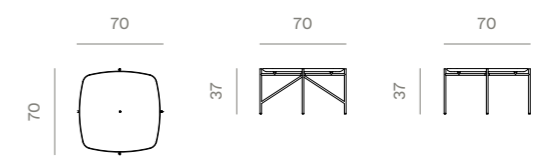

low table

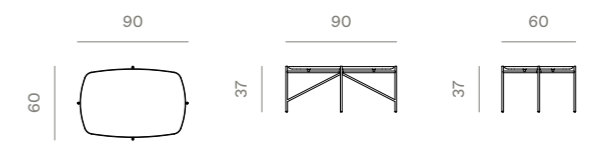

low table

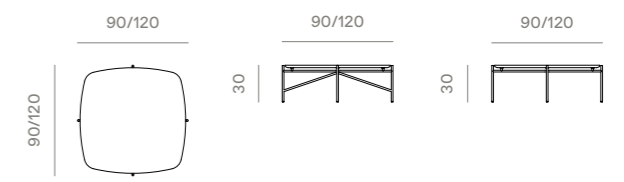

rhomb



The Rhomb chair's organic shape is in opposition with the contemporary rhomboid geometry found in the cross section of the backrest and legs. Tactile and visual qualities of solid wood are accentuated owing to the combination of the state-of-the-art technology and sophisticated manual processing. Additionally, a table with rhomboid shaped legs was designed to match the chair. Its table top has a lens like form and sharp knife edge, which creates its elegant flair, especially when made in lacquered finish with Fenix top.

Design: Simon Morasi Piperčić

Organičnoj konturi stolice suprotstavljena je suvremena romboidna geometrija presjeka naslona i nogu. Zahvaljujući kombiniranju najsuvremenije strojne tehnologije i sofisticirane ručne obrade, istaknute su taktilne i vizualne kvalitete punog drva. Kao dodatak stolcu, dizajniran je stol s nogama romboidnog oblika. Ploča ima zaobljene kuteve i oštro odrezane rubove čime postiže tanak i elegantan izgled, posebice u varijanti lakiranih nogu i Fenix površine.









prostoria

table square

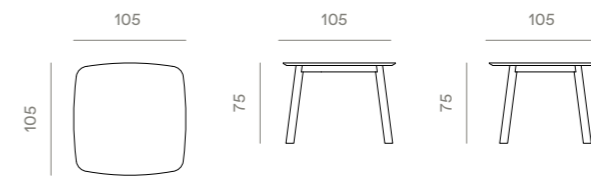

table



table round

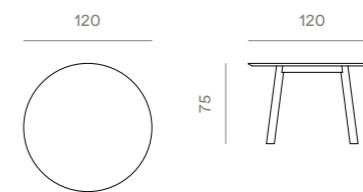

chair



strain



The Strain collection's distinctive character evolves from the particularly strained materials, the fusion of high-end technology and refined craftsmanship. The product family comprises an easy chair, a chair, a low chair, a bar stool and tables of various heights. However, the leg junctions are the main signature of its design language, achieved through the intertwined steel tubes which basically harden the whole construction. All Strain chairs can be upholstered with leather or fabrics for superior comfort.

Design: Simon Morasi Piperčić

Kolekcija Strain svoj prepoznatljivi karakter razvija iz posebno napetih materijala, spoja vrhunske tehnologije i profinjene izrade. Obitelj proizvoda sastoji se od naslonjača, stolice, niske stolice, barske stolice i stolova različitih visina. Glavno obilježje dizajnerskog jezika su međusobno isprepleteni spojevi nogu izrađeni od čeličnih cijevi kojima se postiže krutost konstrukcije. Sjedišta svih stolica iz kolekcije može se ojaštati kožom ili tekstilom radi postizanja dodatne udobnosti.



reddot award
winner 2015



Golden Key
Award







oblique



The Oblique collection ensures a quality sitting experience within minimal dimensions. The profile underlines two triangular prisms. They ensure the greatest thickness of the foam on the major points of support for the body when sitting: the back side of the seat and the lumbar zone of the backrest. The narrowed plane where the volume from the seat blends into the backrest improves the ergonomics, but also allows for the elasticity of the backrest. The top of the legs has a rectangular cross-section, but becomes increasingly thin towards the bottom, turning ultimately into a triangular base. The collection also comprises a larger dining table and low tables.

Design: Numen / For Use

Proizvodi iz kolekcije Oblique pružaju kvalitetu sjedenja u mekanom naslonjaču, ali s minimalnim dimenzijama – ostvarajući potpun doživljaj udobnosti. Iz toga je proizašao prepoznatljiv profil sjedala. Dvije trokutaste prizme koje se ističu u profilu osiguravaju najveće debljine pjene na glavnim točkama oslonaca tijela na stražnjoj strani sjedala i lumbalnoj zoni naslona. Sužena ploha pretapanja volumena iz sjedala u naslon poboljšava ergonomiju, ali i omogućava elastičnost naslona. Vrh nogu kvadratnog presjeka stanjuje se i triangulacijom prelazi u trokut baze. Kolekcija uključuje i veći stol i stoliće.



reddot award
winner 2015



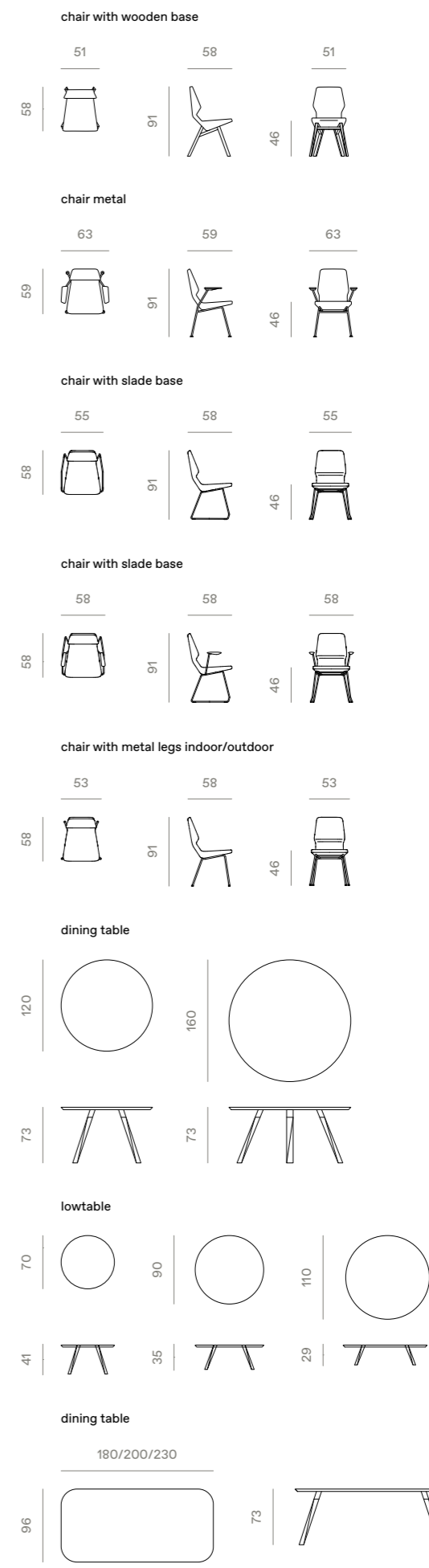
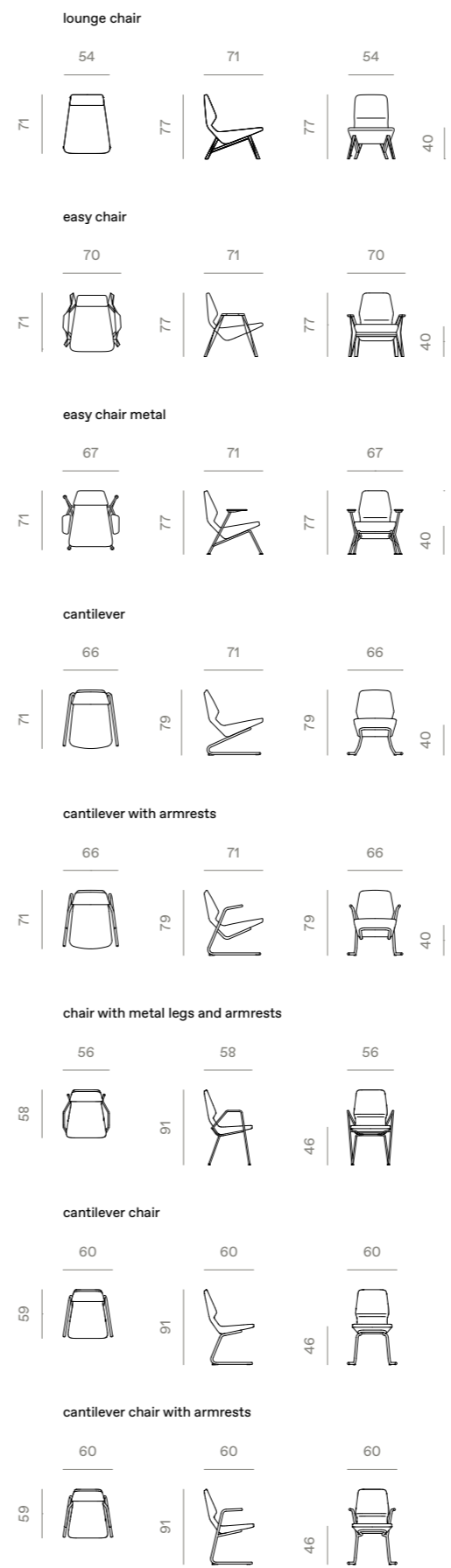

oblikant



Oblikant is a derivation of Oblique family, regardless to the difference in technology and typology from its upholstered siblings, retains the characteristic S shaped profile of the chair. Strong curvature of the shell provides good ergonomics which is further highlighted by the elasticity obtained from this geometry. The shell is made of 2D molded plywood, combined with 6 versions of steel legs of which 4 are stackable, and one solid wood base.

Design: Numen / For Use

Oblikant kao izvedenica obitelji Oblique, nevezano za razliku u tehnologiji i tipologiji od dosadašnje tapecirane stolice, zadržava njezin karakterističan S-profil. Izražena zaobljenost školjke pruža dobru ergonomiju koja je posebno naglašena i elastičnošću koja proizlazi iz same geometrije. Školjka je izrađena iz 2D savijene šperploče, u kombinaciji sa šest varijanti metalnih nogu od kojih se četiri mogu slagati jedna na drugu te jedne varijante drvenih nogu.







oblikant chair

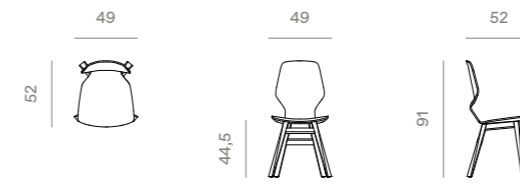

oblikant chair cantiliver

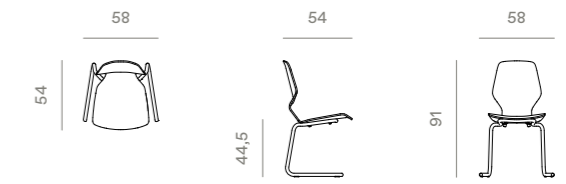

oblikant chair sled base

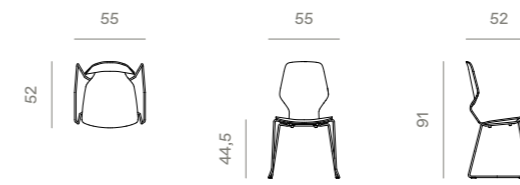

oblikant chair cantilever

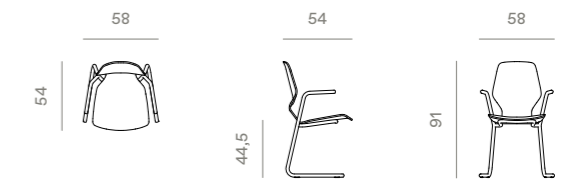

oblikant chair sled base

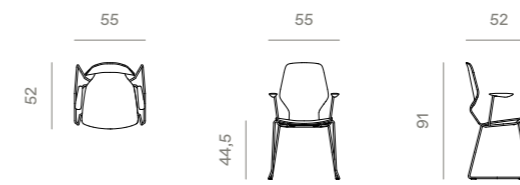

oblikant chair metal legs

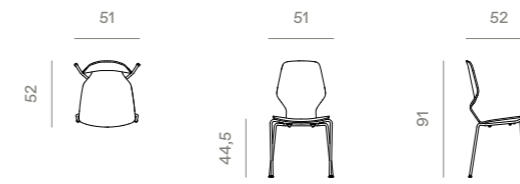

oblikant chair metal legs with armrests

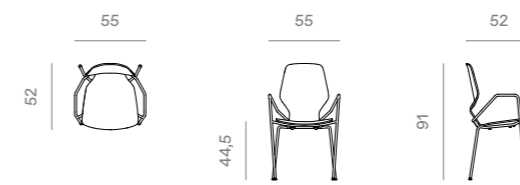

piun



With its airy flair, the design of the Piun chair revolves around lightness, functionality and comfort, which are all necessary for the dining setting. The challenge was to design a light and stackable chair with armrests for mass seating. Additionally, Piun is quite slim, a functionality that allows placing more chairs around the table, without overcrowding the area. Its metal body carries the expression of an embrace, enveloping the wooden backrest. At first Piun was designed as a monochromatic compound of form and color, but it is actually available in various combinations.

Design: Grupa

Svojim prozračnim karakterom, dizajn stolice Piun posebno je funkcionalan, a ona sama udobna, lagana za prenošenje i slaganje. Njezina izrazita „vitkost” omogućuje postavljanje većeg broja stolica oko stola, bez osjećaja manjka prostora. Metalna konstrukcija gornjeg dijela stolice djeluje kao da obgrljuje sjedište, spajajući se s drvenim naslonom, svojevrsnim likovnim akcentom Piuna, zahvaljujući kojem ona ne nestaje ispod stola, već ostaje decentno primjetna. Inicijalno zamišljen monokromatski, kao spoj forme i boje, Piun je također dostupan u raznovrsnim kombinacijama materijala i površinske obrade.





chair



trifidae



Trifidae are a collection of seats that includes three different armchairs and one chair. Consisting of three separate parts, the small easy chair, high backrest armchair, lounge chair and a chair – share the same triangulated form with the focal point in the central part, embracing the user's lumbar area and functioning as an armrest. The tilting of the three parts of the armchairs resembles closing and openings of the petals of flower buds.

Design: Numen / For Use

Trifidae kolekcija se sastoji od tri različita naslonjača razvijena iz zajedničkog tipološkog i oblikovnog ishodišta. Naslonjač, stolica, naslonjač s visokim naslonom i veliki naslonjač imaju karakterističnu, trodijelnu strukturu te dijele slične trokutne forme koje se šire iz zamišljenog središta rezultirajući specifičnim, „biljnim” karakterom objekata. Zaokretanje triju osnovnih strukturalnih dijelova u korištenju asocira na otvaranje i zatvaranje cvjetnih pupoljaka.







lounge chair with wooden base

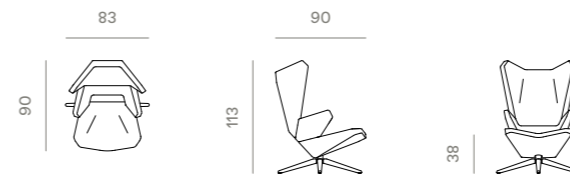

lounge chair

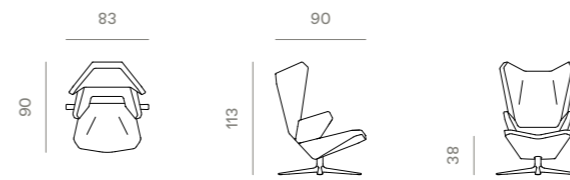

armchair with wooden base



armchair metal

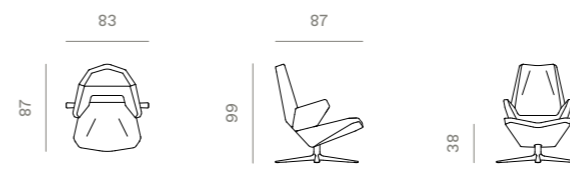

pouf



easy chair



chair



low tables

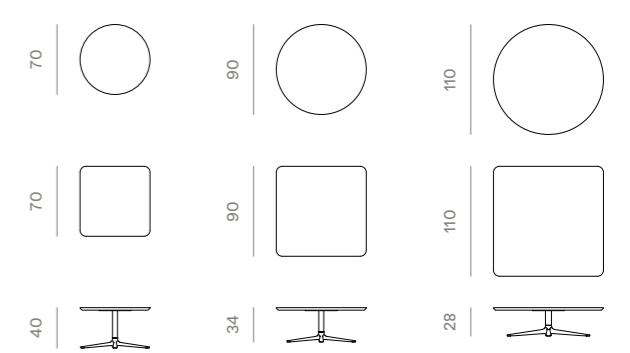

tables

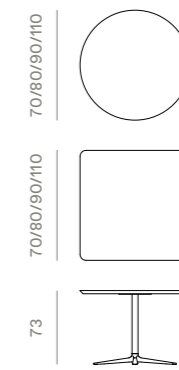

bar tables

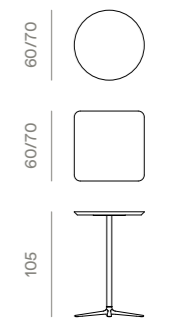

dobra



Dobra is a solid wood chair which was originally supposed to be called Sunday as it was inspired by easy-going Sunday mood. The traditional typology of a wooden chair with armrests was reinterpreted by the application of a characteristic 'break' in the geometry of the front legs. The design has achieved a gracious form of solid wood with the fragile flair thanks to a highly thin and superlight chair's body. Dobra provides firm and stable support in a sitting position due to rounded geometry of its backrest and armrests resulting in ergonomics that trigger a sense of comfort.

Design: Numen / For Use

Dobra je stolica od čvrstog drveta koja se isprva trebala zvati Sunday jer je inspirirana opuštenim nedjeljnim ugođajem. Reinterpretirali smo tradicionalnu tipologiju drvene stolice s rukonaslonima služeći se karakterističnim lomom u geometriji prednjih nogu. Dizajnom je postignuta gracilna forma od drveta koja zbog vrlo tankog i laganog tijela pruža doživljaj krhkosti. Kružna geometrija rukonaslona i naslona omogućava solidnu potporu sjedenju i rezultira ergonomijom koja potiče udobnost.







dobra chair

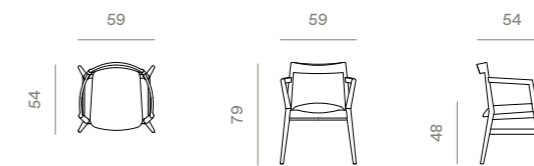

bik



Bik is the chair reduced to its basic elements: four legs, seat and a backrest. Barely visible decrease of width of the legs, frontward inclination of the back legs and slightly overstated curvature of the backrest define the character of this, otherwise archetypal chair. Wider back legs are slightly detached aside enabling easy stacking when chairs are not in use. The structure is made of solid wood, while the seat and the backrest are made of molded plywood.

Design: Numen / For Use

Bik je stolica svedena na bazične elemente: četiri noge, sjedalo i naslon. Jedva vidljivo stanjenje nogu, stražnje noge nagnute prema naprijed te pomalo prenaplašena zakrivljenost naslona definiraju karakter ove stolice, koja inače posve odgovara svome arhetipu. Šire stražnje noge postavljene su bočnije, što omogućava slaganje jedne stolice na drugu kada se ne koriste. Konstrukcija je izrađena iz masiva, dok su sjedalo i naslon od savijene šperploče. Stolica je dostupna u verziji s kraćim i dužim naslonom.





chair with long backrest



chair with short backrest



chair with long backrest / upholstered seat



chair with short backrest / upholstered seat



chair with long backrest / upholstered seat



chair with short backrest / upholstered seat



3angle



Design of the 3angle armchair and two-seater sofa follows fragmented, crystal-like forms systematically describing a compact volume, almost like an algorithm. This solution is not only formal – the characteristic 3angle armrests follow the ergonomic line of relaxed arms. A soft shell of the backrest and armrest is covered with a continuous cover whose edges are marked only with a very subtle line of seams. A light metal sub-construction reproduces the characteristic triangular motif contributing to the compactness of the composition.

Design: Grupa

Dizajn naslonjača i dvosjeda karakteriziraju razlomljene kristalične plohe koje poput matematičkog algoritma opisuju kompaktni volumen. Rješenje nije samo formalno, jer karakteristični rukonasloni prate ergonomski opušten položaj ruku. Mekana školjka naslona i rukonaslona prekrivena je kontinuiranom presvlakom na kojoj su bridovi samo naznačeni tankim šavovima. Tanka crna metalna podkonstrukcija ponavlja karakterističan motiv trokuta, što doprinosi kompaktnosti kompozicije.







armchair

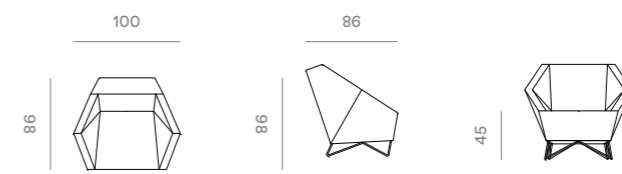

2seater

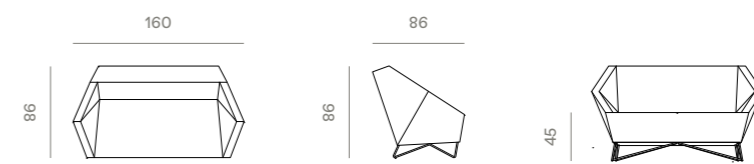

pouf



outdoor
furniture

namještaj
za eksterijer



outdoor



The Umomoku collection consists of a chair, two-seater, three-seater, sun lounger, coffee table and a tray and they are all designed to serve as an oasis of personal hedonism in outdoor areas such as large terraces of hotels and villas. Its elementary design is evident in the wooden structure and slats on the back of seating elements with a sumptuous cushion that induces comfort. The sun lounger is particularly functional as it allows easy handling of the backrest on both sides providing various forms of use. Next to the headboard, there is an extension made of slats for storing drinks and treats.

Design: 3LHD

Kolekciju Umomoku čine naslonjač, dvosjed, trosjed, ležaljka, stolić i pladanj, a osmišljeni su tako da u vanjskim prostorima poput velikih terasa hotela i vila služe kao oaza osobnog hedonizma. Dizajn kolekcije je elementaran, što se posebno ističe u drvenoj konstrukciji i letvicama na leđima sjedećih elemenata, dok raskošni jastuk pruža udobnost. Ležaljka je posebno funkcionalna jer omogućuje otvaranje naslona za ležanje s obje strane, što je dobrodošla mogućnost za raznolike situacije, dok je pored uzglavlja smješteno proširenje od letvica za odlaganje pića i poslastica.





Osmo is a series of seating objects developed on the classic typology of chairs for terraces in hotels and restaurants. The steel structure combined with wooden seat and backrest provides an optimal equilibrium of comfort and rigidity required in demanding context of extensive use in exterior exposed to sun and seawater. A bent tube structure defines the frame in which the seat and backrest made of wooden slates are inserted into. The characteristic inclination of front legs combined with extremely wide, fractured armrest, results in a biomorphic appearance reminiscent of an insectoid robot from SF movies.

Design: Numen / For Use

Seriya sjedala Osmo razvijena je na klasičnoj tipologiji ugostiteljskih stolica za terase hotela i restorana. Čelična konstrukcija s drvenim sjedalom i naslonom osigurava optimalan omjer robusnosti i udobnosti neophodan u kontekstu ekstenzivnog korištenja u eksterijeru izloženom suncu i posolici. Konstrukcija od svinute cijevi definira okvir u koji su umetnuti sjedalo i naslon izrađeni od profiliranih drvenih letvica. Karakterističan kut prednjih nogu stolica u kombinaciji s izrazito širokim, "prelomljenim" rukonaslonima rezultira biomorfnim izgledom insektoidnog robota iz SF filmova.





The Coo Coo birdhouse is a closed shelter for small birds created from bent metal. Tin sheet edges are welded to host a wooden bar whose function is to provide a rest stop for birds. Very delicate tin surface creates a transparent frontal view while the side view clearly discloses the form and function of the birdhouse. Minimalist design has breathed new life in this otherwise marginalized object by expanding its primary function into decorative one.

Design: Filip Gordon Frank

Prozračna forma kućice za ptice Coo Coo kreirana je savijanjem metalnog lima u zatvoreno sklonište za manje ptice. Krajevi lima se vare kako bi se u toj točki postavila drvena prečkica u funkciji odmorišta za ptice. Tanka ploha lima kreira gotovo nevidljiv dojam sprijeda, dok pogled s boka odaje jasnu formu i funkciju objekta. Minimalističkim dizajnom je ovom, inače marginaliziranom predmetu udahnut novi život, a on je pored svoje primarne svrhe postao i dekorativnim predmetom u interijeru.





The Jugo outdoor collection is designed to contrast the rational form of powdered construction made of stainless steel to the oversized wooden armrests and lavish cushions. The seat and the backrest are inclined at an angle that provides high-level ergonomics in the seating position. All surfaces for tables and low tables are made from wooden and metal slates, selected as durable materials that mature gracefully. Distinctly accentuated discs on the legs are another characteristic design feature whose function is to ensure various modalities of use on soft or sandy surfaces.

Design: Numen / For Use

Jugo je outdoor kolekcija čiji dizajn suprotavlja racionalnu formu plastificirane konstrukcije od inoksa raskošnim jastucima i rukonaslonima od punog drva. Sjedala i nasloni ukošeni su u mjeri koju zahtijeva kvalitetna ergonomija sjedenja. Plohe stolova i niskih stolića izrađene su od drvenih i metalnih letvica, dugovječnih materijala koji graciozno stare. Karakteristična crta dizajna su i prenaplašeni diskovi na nogama koji proizlaze iz funkcije da osiguraju mogućnost korištenja na mekanim ili pješčanim površinama.







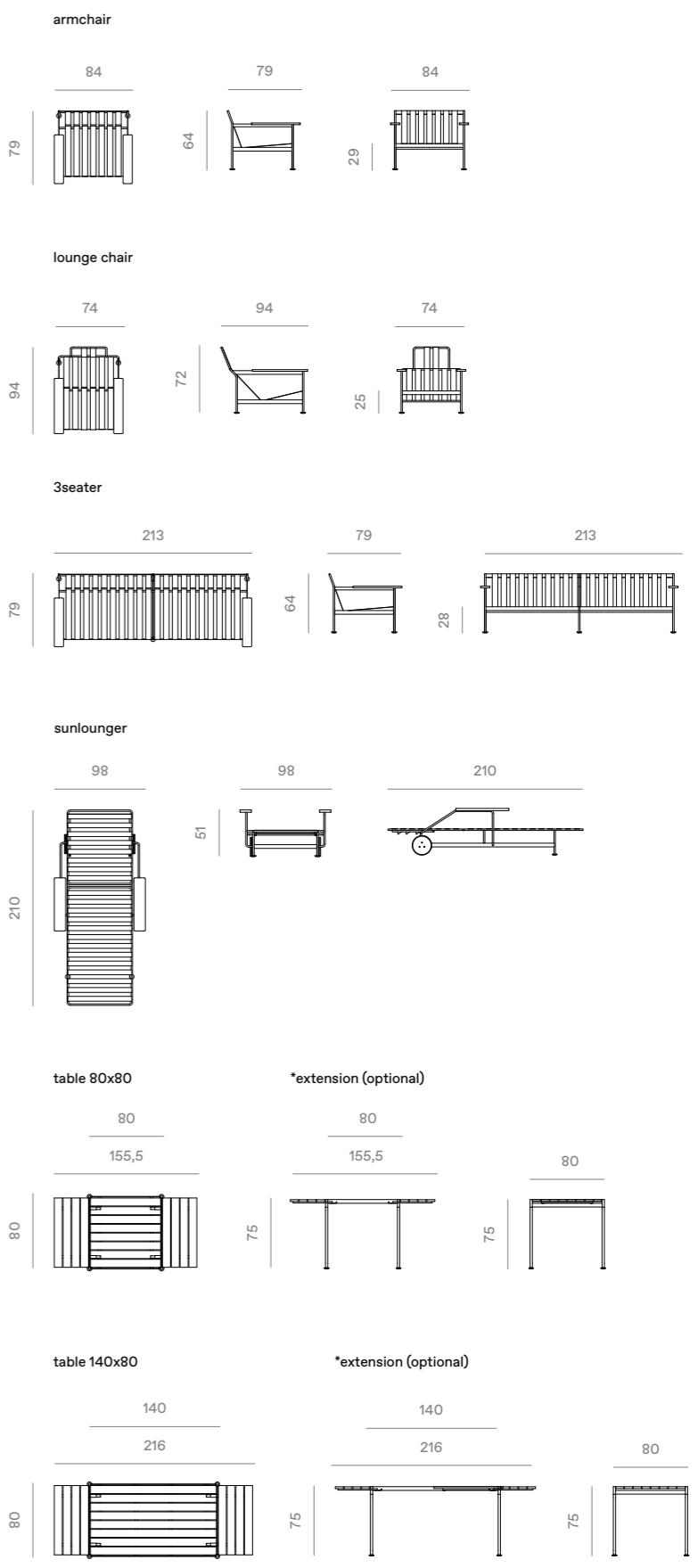
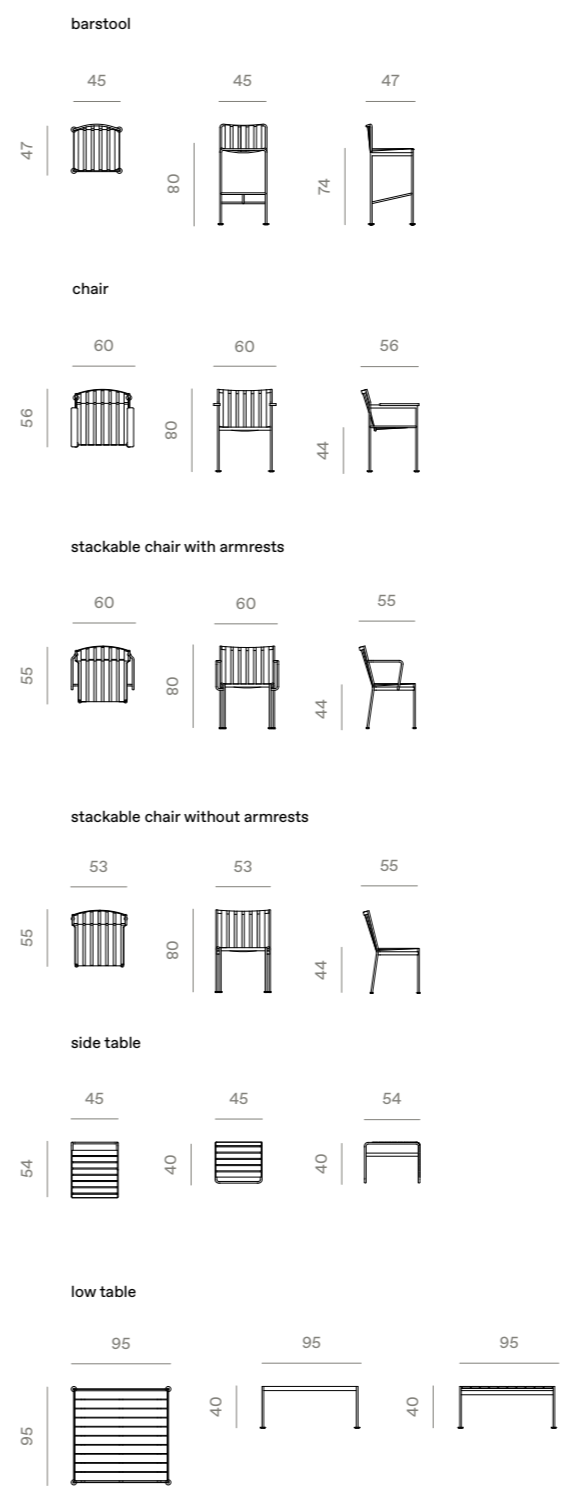
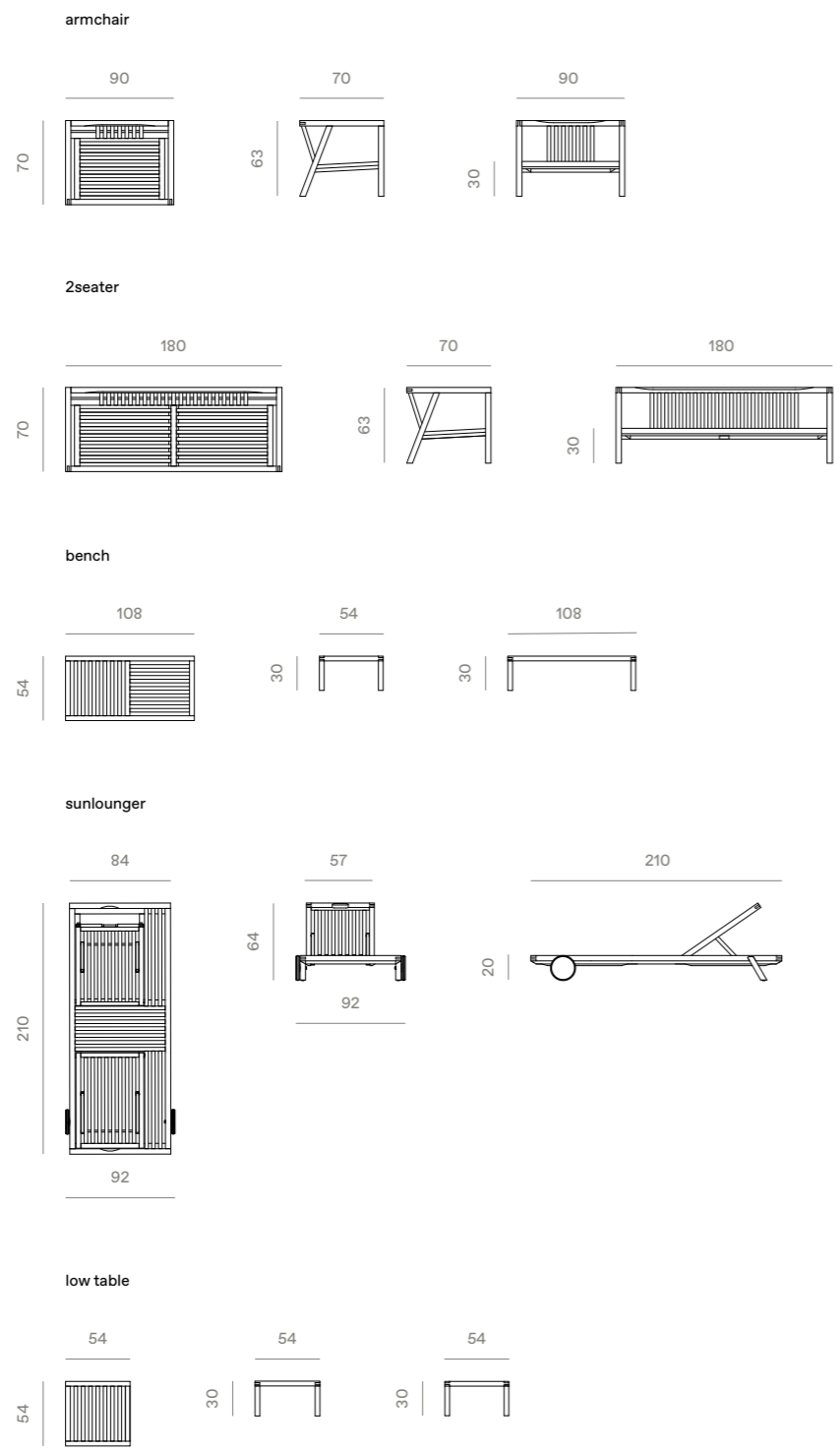

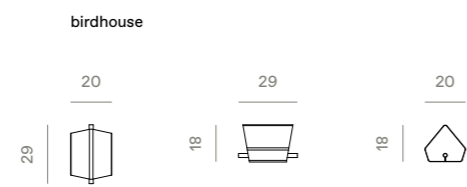

birdhouse stand S / stand M / stand L

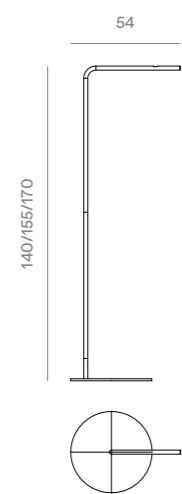

chair

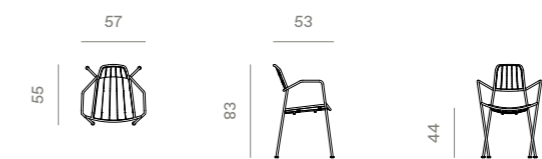

easy chair



metal chair (steel or inox)

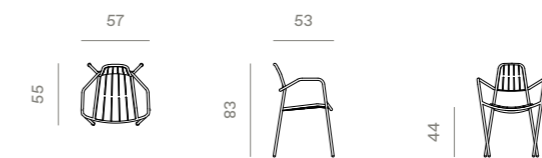

metal easy chair (steel or inox)





designers dizajneri

Numen / For Use



Numen/For Use is a design collective led by product designers Sven Jonke, Christoph Katzler and Nikola Radeljković. Over the past 20 years, Numen/For Use has been active globally in the fields of industrial and spatial design, scenography and conceptual art. It nourishes very rational aesthetics that could be categorized as functional minimalism. Their designs for Prostorja include the Polygon, Oblique and Trifidae easy chairs, Oblikant, Bik, Dobra and Osmo chairs, Revolve, Layout, Absent, Segment, Combine and Fade sofas and the Jugo outdoor collection.

3LHD



3LHD is an acclaimed architectural practice that integrates architecture, art and (urban) landscape. Their projects, such as the Memorial Bridge in Rijeka, Riva Waterfront in Split, Spaladium Center, Hotel Lone, Hotel Grand Park Rovinj, Hotel Adriatic and many others, have established them as one of the key drivers in Croatian architecture. For Prostorja, 3LHD designed the Umomoku outdoor collection. The collection was initially designed for the luxury beach Mulini in Rovinj and subsequently redesigned for serial production.

Numen/For Use (Sven Jonke, Christoph Katzler, Nikola Radeljković) je hrvatsko-austrijski dizajnerski kolektiv koji radi na području scenografije, industrijskog dizajna, dizajna interijera i konceptualne umjetnosti. Njihova je estetika vrlo racionalna i mogla bi se kategorizirati kao funkcionalni minimalizam. Za Prostoriju su dizajnirali naslonjače Polygon, Oblique, Trifidae, stolice Oblikant, Bik, Dobra i Osmo, sofe Revolve, Layout, Absent, Segment, Combine i Fade te kolekciju za vanjske prostore Jugo.

3LHD je poznati arhitektonski studio koji integrira arhitekturu, umjetnost i (urbani) krajolik. Njihovi projekti kao što su Most hrvatskih branitelja, Riva Split, Centar Spaladium, Hotel Lone, Hotel Grand Park Rovinj, Hotel Adriatic i drugi čine ih jednim od glavnih pokretača hrvatske arhitekture. Za Prostoriju je 3LHD dizajnirao kolekciju namještaja Umomoku. Kolekcija za vanjske prostore, izvorno dizajnirana za Plažu Mulini u Rovinju, a naknadno je bila redizajnirana za serijsku proizvodnju. Za Prostoriju su još dizajnirali i police Shtef.

Lea Aviani

Lea Aviani is the founder of Projectum, her Split-based design studio. Her designs have been produced by several international companies, although most of her work focuses on interior design. In her designs, Lea Aviani tries to unite tradition and innovation, with the strong influence of the Mediterranean way of life.

Meike Harde

Meike Harde is a Cologne-based designer specialized in textile crafts. She is using her vastly amassed empirical knowledge to create unconventional upholstery designs. With traditional tailoring techniques and a focus on cleverly placed seams, simple but novel designs revel in the natural character of fabric. Her design for Prostorja includes the Impression collection.

Simon Morasi Piperčić

Founded in 2013, Simon Morasi Piperčić is a Zagreb-based industrial design agency working on various projects ranging from industrial and spatial design to site-specific installations, art direction and design consultancy. His work has been published in several renowned magazines (Dezeen, Domus, Frame, Hypebeast...) and exhibited worldwide. Simon M. Piperčić's designs for Prostorja include the Strain collection, Rhomb collection and the Convert modular system.

Lea Aviani je osnivačica dizajnerskog studija Projectum sa sjedištem u Splitu. Njezine dizajnerske projekte proizvodi nekoliko međunarodnih kompanija, iako se većinom bavi uređenjem interijera. Svojom dizajnom pokušava objediniti tradiciju i inovaciju pod snažnim utjecajem mediteranskog načina života. She has designed Bavul bench-bed for Prostorja.

Meike Harde njemačka je dizajnerica specijalizirana za dizajn tekstila. U svojem radu koristi bogato empirijsko znanje u kreiranju nekonvencionalnog dizajna ojastučenih proizvoda. Pritom koristi tradicionalne krojačke tehnike i šavove kao motiv svojeg dizajna koje funkcionalno pozicionira na proizvodima, ujedno ističući prirodni karakter tkanine. Za Prostoriju je dizajnirala kolekciju Impression.

Simon Morasi Piperčić je dizajnerski studio osnovan 2013. koji se bavi različitim projektima, od industrijskog i prostornog dizajna do ambijentalnih instalacija, umjetničke direkcije i dizajnerskog savjetovanja. Radovi Simona Morasi Piperčića su objavljeni u nekoliko priznatih časopisa (Dezeen, Domus, Frame, Hypebeast...) i izlagani u cijelom svijetu. Za Prostoriju je dizajnirao kolekciju Strain i Rhomb te modularni sistem Convert.



Neisako



Neisako is a small design practice focusing on innovative and inspiring product design solutions. Previously working as Redesign, from 2020 it operates under the new name — Neisako. Studio works in a wide variety of design fields mostly driven by investigation in deeper meaning of creation through language of geometry. For Prostorija, they have designed Up-Lift and Pil-low sofa-beds, Kontrapunkt recliner and Simetria coat stand.

Sanja Knezović



Sanja Knezović is primarily an architect who heads her own architectural studio specialized for designing private houses and smaller commercial buildings. She has transferred the experience gained from designing furniture units for interiors onto designing upholstered furniture for Prostorija, her first project in the field of product design. For Prostorija, Sanja Knezović designed the Match and Cloud sofa-beds.

Grupa



Grupa (Filip Despot, Ivana Pavić, Tihana Taraba) is a Croatian design studio and a lighting objects brand. Their products are distinguished by minimalism, functionality and flexibility to one's personal choice. For Prostorija, Grupa designed the Monk collection, 3-angle sofa, Tinker easy chair, Piun chair and Shtef shelves.

Neisako je multidisciplinarni dizajnerski studio usmjeren na razvoj koncepata novih proizvoda i tehnoloških inovacija. Zahvaljujući dobrom poznavanju različitih područja tehnologije, do sada su realizirali širok raspon projekata – od dizajna recikliranih kartonskih polica do sofisticiranog uređaja za rehabilitaciju, testiranje i trening zgloba koljena. Za Prostoriju su dizajnirali garniture na razvlačenje Up-Lift i Pil-low, naslonjač-ležaljku Kontrapunkt i vješalicu Simetria.

Sanja Knezović je primarno arhitektica koja vodi vlastiti arhitektonski studio projektirajući privatne kuće i manje poslovne objekte. Svoje iskustvo dizajniranja komadnog namještaja za interijere pretočila je u dizajn ojastučenog namještaja za tvrtku Prostorija, njezin prvi projekt na području produkt dizajna. Za Prostoriju je dizajnirala modularne garniture Match i Cloud.

Grupa (Filip Despot, Ivana Pavić, Tihana Taraba) je hrvatski dizajnerski studio i brend za rasvjetne predmete. Njihovi se proizvodi razlikuju po svom minimalizmu, funkcionalnosti i fleksibilnoj prilagodbi osobnom odabiru. Grupa je za Prostoriju dizajnirala kolekciju Monk, dvosjed 3-angle, naslonjač Tinker, stolicu Piun i police Shtef.

Borovnjak & Bratović

Ivana Borovnjak and Roberta Bratović are product designers who work together on self-initiated projects in product design and visual communications. Apart from that, they work on projects in the fields of culture, art, theatre and nonprofit organisations from Amsterdam, London and Zagreb. For Prostorija, they designed the Revolve sofa-bed in collaboration with Numen/ForUse.

Filip Gordon Frank

Filip Gordon Frank is an industrial and interior designer with his own studio where he combines product and interior design. His company Polymorph manufactures the line of his own designs. For Prostorija, he has designed the Coo Coo birdhouse.

RU:T

Studio RU:T is a multidisciplinary design studio founded by Tvrtko Bojić and Karla Paliska specializing in product and industrial design, visual communications, spatial concepts and on-site interventions. In their work, they focus on practical and sustainable solutions as well as experiments that question the concept of living. For Prostorija, Studio RU:T designed the Knif shelving system.

Ivana Borovnjak i Roberta Bratović su produkt dizajnerice koje zajedno rade na samostalnim projektima iz produkt dizajna i vizualnih komunikacija. Uz to rade i na projektima iz kulture, umjetnosti, kazališta te za neprofitne organizacije iz Amsterdama, Londona i Zagreba. Za Prostoriju su zajedno sa studijom Numen/ForUse dizajnirale Revolve, sofuu koja se transformira u krevet.

Filip Gordon Frank je industrijski dizajner i dizajner interijera koji u svom studiju kombinira produkt dizajn i dizajn interijera. U svojoj tvrtki Polymorph proizvodi liniju svojih proizvoda. Za Prostoriju je dizajnirao kućicu za ptice Coo Coo.

Studio RU:T je multidisciplinarni dizajn studio (Tvrtko Bojić, Karla Paliska), a koji djeluje na području produkt i industrijskog dizajna, vizualnih komunikacija, prostornih koncepata i intervencija. U svom radu fokusiraju se na praktična i održiva rješenja, kao i eksperimente kojima propituju koncepte življenja. Za Prostoriju su dizajnirali sustav polica Knif.



publisher	izdavač	prostorja d.o.o. Pustodol Začretski 19G 49223 Sv. Križ Začretje, Croatia t +385 49 200 555 e info@prostorja.eu www.prostorja.eu
text	tekst	prostorja
art direction of set design	umjetnička direkcija scenografije	Grupa
layout design	dizajn publikacije	Design Bureau Izvorka Jurić
photography	fotografija	Domagoj Kunić Damir Kovačić Vanja Šolin Marko Ercegović
print	tisak	Printera, Zagreb 2021

This brochure is for informational purposes only and it is made in accordance with the information at the time of printing. Deviations of ±3 cm in product dimensions are possible. We are not responsible for any printing errors, subsequent product changes or image fidelity. We kindly ask you to contact our authorised sales outlets for all queries regarding product characteristics and appearance, and any additional or new information required for reaching a final purchase decision.

All rights reserved. © 2021 prostorja Ltd

This brochure is for informational purposes only and it is made in accordance with the information at the time of printing. Deviations of ±3 cm in product dimensions are possible. We are not responsible for any printing errors, subsequent product changes or image fidelity. We kindly ask you to contact our authorised sales outlets for all queries regarding product characteristics and appearance, and any additional or new information required for reaching a final purchase decision.

All rights reserved. © 2021 prostorja Ltd

strain
oblique
oblikant
piun
trifidae
dobra
bik
3angle
umomoku
osmo
coo coo
jugo

prost

coria 20