



# befame

# Bullet

Imagine a simple, modern interior with an eye-catching item - the Bullet corner sofa. It's easy to fall in love with the unique rounded design, the more so that the combination of high-quality springs with highly flexible foam and adjustable headrests ensures exceptional comfort of everyday use. Additional advantages include sleeping function and bedding container. The Bullet is the very essence of beauty and luxury, although extremely practical.

## Corner sofas

Available in a left-hand or right-hand configuration. The sets below are left-hand facing.

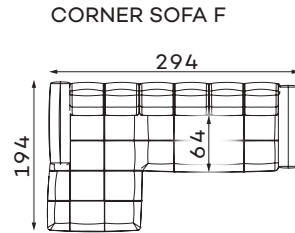
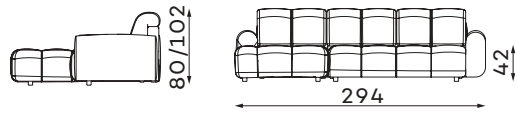

**SLEEPER SIZE**  
240 x 137 cm

Also available  
without sleeping  
function

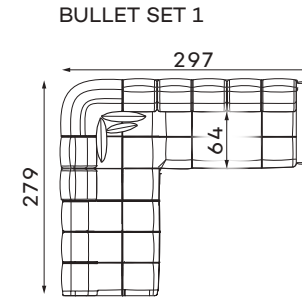

## Sofas

### 2-SEATER SOFA

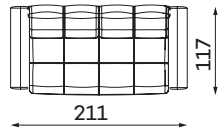

## Modular units

Available in a left-hand or right-hand configuration. The units below are left-hand facing.

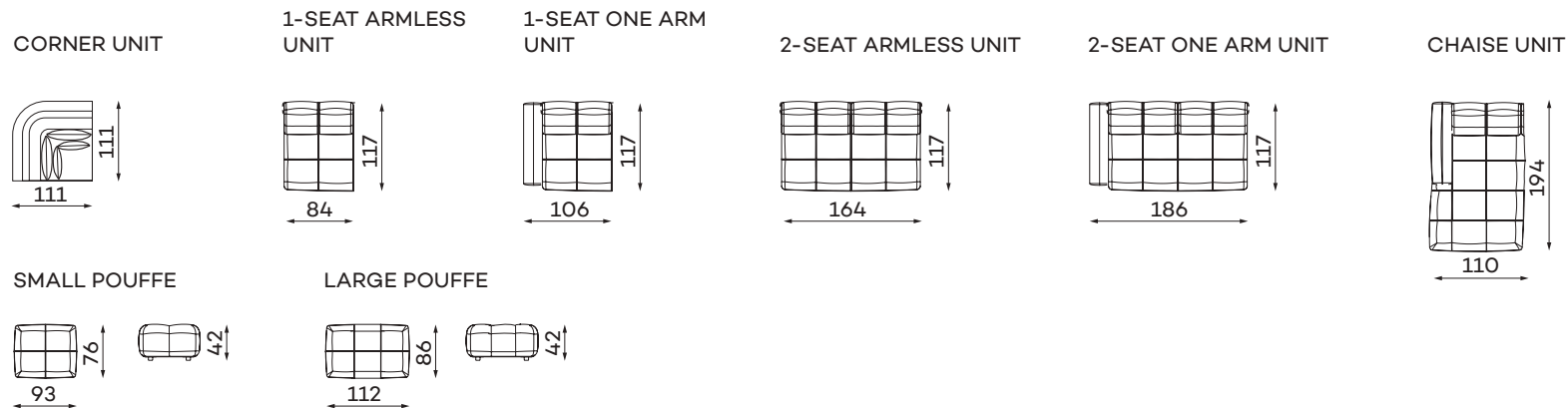

All dimensions of upholstered furniture are given with a tolerance of +/- 4 cm.

## Other dimensions

---

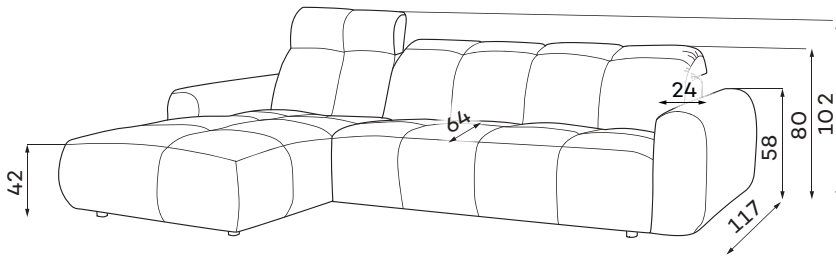

## What makes the Bullet sofa stand out?

---



They make the seat more flexible and provide excellent underlying support for a highly flexible foam layer.



The highly-flexible foam improves the durability and elasticity of the seat, preventing deformations.



The ergonomic and comfortable design of the backrest and seat perfectly fits the curve of the human body.



Adjustable headrests



You can choose the fabric from dedicated series, including easy-to-clean fabrics.

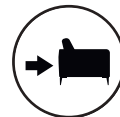

The upholstered back allows you to put it in the middle of the living room.



Sleeping function



Bedding container

V 02. Product images are for illustrative purposes only and may differ from the actual product. Dimensions in technical descriptions are approximate and may vary (with a tolerance of +/- 3% -4%). The company reserves the right to change the technical specifications provided in product datasheets for regular updates without prior notice.